

xStart

Start easily, protect precisely



EATON

Powering Business Worldwide

EAT•N

The power of fusion.

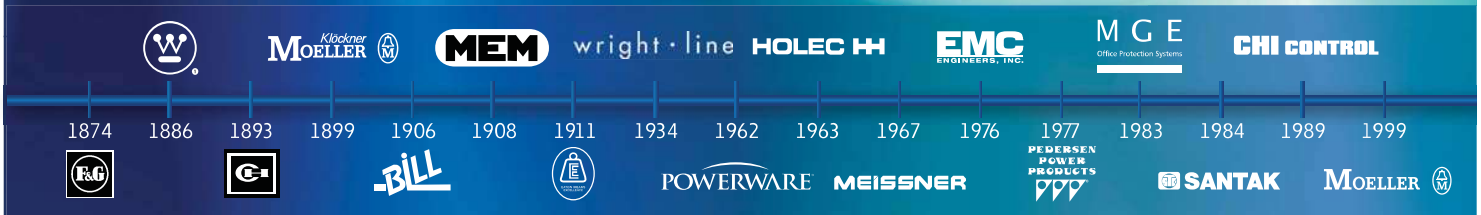

EAT•N
Powering Business Worldwide

There's a certain energy at Eaton. It's the power of uniting some of the world's most respected names to build a brand you can trust to meet every power management need. The energy created supports our commitment to powering business worldwide.

Eaton is dedicated to ensuring that reliable, efficient and safe power is available when it's needed most. With unparalleled knowledge of electrical power management across industries, experts at Eaton deliver customized, integrated solutions to solve our customers' most critical challenges. Eaton.com/Electrical.

All of the above are trademarks of Eaton Corporation or its affiliates. Eaton has a license to use the Westinghouse brand name in Asia Pacific. ©2012 Eaton Corporation.



Mini contactor relays, contactor relay, contactors DIL	1
Overload relay Z..., ZEB, ZEV, EMT6	2
Motor protective circuit breaker PKZ and PKE	3
MSC motor-starter combinations	4



Mini contactor relays, contactor relay, contactors

Continual operation requires high operational reliability in the components used. The DILM contactor achieves the best lifespan values in AC-3 applications and is ideal for heavy AC-4 jogging.



Eaton After Sales Service

Testing switching devices in compliance with regulations applicable to this technology
→ Chapter 22

Mini contactor relay DILE..., contactor relays, contactors up to 12 A AC-3 at 400 V

Compact dimensions for the highest packing densities +++ Extended performance range up to 5.5 kW at 400 V

AC and DC contactor system DILM..., contactor relays, 3 pole contactors up to 170 A AC-3 at 400 V, 4 pole contactors up to 200 A AC-1

Easier engineering through identical construction sizes for AC- and DC-operated contactors +++ Energy savings and higher packing density in control panel due to minimized heat dissipation +++ High wiring security through doubled box terminals +++ Less coupler relays: direct actuation from the PLC for contactors up to 32 A +++ Easy engineering through integrated suppressor circuits for DC +++ Uniform accessories for 3- and 4-pole contactors +++ Mechanical interlock double conductor run mountable without additional separation gap +++ Direct fieldbus connection through the communication system SmartWire-Darwin, through plug-in type protective module











High rated contactors- contactors up to 1600 A AC-3 at 400 V, contactors up to 2600 A AC-1



Compact dimensions with high switching power +++ Direct actuation from the PLC saves coupler relays +++ Easy engineering through wide range coils +++ Cost and energy savings for control panel ventilation due to reduced heat dissipation +++ Long lifespan through vacuum technology from 580 A



SmartWire-Darwin

The DIL product range offers contact elements which can be connected to the SmartWire-Darwin communication system. → Protective modules, Page 5/62

	1.1 Ordering	Mini contactor relays DILER, DILEEM, DILEM Mini contactor relays, contactors 2 Auxiliary contact modules 6 Accessories 8 Actuating voltages 70 DILA contactor relays Contactor relays 10 Auxiliary contact modules 12 Actuating voltages 72
	1.2 Technical overview	1.2 Technical overview Contactors DILM, DILH 14
	1.3 System overview	1.3 System overview Contactors DILM, DILH 16
	1.4 Ordering	1.4 Ordering Contactors DILM, DILH Basic devices up to 170 A 18 Complete units up to 170 A 24 Standard devices greater than 170 A 28 Comfort devices greater than 170 A 30 Basic devices up to 200 A, 4 pole 34 Auxiliary contact modules 36
	1.5 Engineering	1.5 Engineering Auxiliary contact modules 40
	1.6 Ordering	1.6 Ordering DILK contactors for capacitors 41
	1.7 Engineering	1.7 Engineering Contactors for power factor correction 42
	1.8 Ordering	1.8 Ordering Star-delta combinations SDAINL 44
	1.9 Engineering	1.9 Engineering Star-delta combinations SDAINL 46
	1.10 Ordering	1.10 Ordering DIUL reversing combinations 48
	1.12 Description	1.12 Description CMD contactor monitoring device 64
	1.12 Ordering	1.12 Ordering CMD contactor monitoring device 64

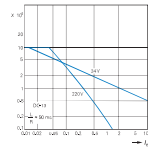
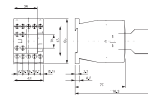
	1.11 Ordering	1.11 Ordering DILM contactor relays, DILM, DILH contactors suppressor circuit 50 Accessories 52
	1.13 Ordering	1.13 Ordering Actuating voltages contactors DILM, DILH Basic devices up to 170 A 69 Basic devices up to 200 A, 4 pole 74 Contactors up to 150 A with electronic actuation 76 Replacement coils 71 Comfort devices greater than 170 A 77 Standard devices greater than 170 A 77 Electronic modules including coil 77 Contactors for capacitors 77
	1.14 Engineering	1.14 Engineering Contact travel diagrams 78 Enclosure 79 UL/CSA-Approved rating data 80 UL/CSA Special Purpose Ratings 81 UL/CSA Short Circuit Current Rating 82 Contactors for resistive loads 84 Electrical life span 86 Short-time loading 90 Operating frequency 91 Switching of DC current 92
	1.15 Technical data	1.15 Technical data Mini contactor relays, contactor relays 93 Contactor monitoring device 96 Basic devices up to 170 A 104 Basic devices up to 200 A, 4 pole 120 Comfort devices greater than 170 A 112 Standard devices greater than 170 A 112 Contactors for capacitors 123 Contactors up to 150 A with electronic actuation 126 Lighting contactors 125 Auxiliary contact modules 128 Accessories 128
	1.16 Dimensions	1.16 Dimensions Mini contactor relays 130 Contactor relays 131 Basic devices up to 170 A 131 Basic devices up to 200 A, 4 pole 133 Contactors larger than 170 A 134 Contactors for capacitors 136 Lighting contactors 136 Contactor combinations 137 Accessories 138

1.1

Contactors

Mini contactors, relays

1 Ordering

Screw terminals



DILER mini contactor relays

Rated operational current

AC-15

220 V	380 V
230 V	400 V
240 V	415 V

Conventional free
air thermal current

Contact

N/O = normally open contact
NC = normally closed contact

Distinctive
number

Circuit symbol

For use with

I_e	I_e	I_{th}	Contact		Distinctive number	Circuit symbol	For use with
A	A	A					
6	3	10	4 N/O	—	40E		DILE...
			3 N/O	1 NC	31E		DILE...
			2 N/O	2 NC	22E		DILE...

Notes

Coil terminal marking as specified in EN 50005

Contact numbers to EN 50011

The following applies to DC-operated contactors:

- Integrated diode-resistor combination
- Coil rating 2.6 W

Information relevant for export to North America



Product Standards

IEC/EN 60947-4-1; UL508; CSA-C22.2 No.14-05;
CE marking

UL File No.

E29184

UL CCN

NKCR

CSA File No.

012528

CSA Class No.

3211-03

NA Certification

UL Listed,

CSA certified

AC operation	Price	DC operation	Price	Std. pack	Notes
Part no. Article no.	See price list	Part no. Article no.	See price list		

DILER-40(230V50HZ) 051759	DILER-40-G(24VDC) 010223	5 off	
DILER-31(230V50HZ) 051768	DILER-31-G(24VDC) 010157		
DILER-22(230V50HZ) 051777	DILER-22-G(24VDC) 010042		

With screw terminals:

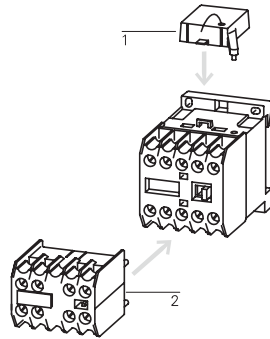

Accessories

- 1 Suppressor
- 2 Auxiliary contact modules
- Further actuating voltages

Page

- 8
- 6
- 66

1.1

Contactors

Mini contactors, relays

1

DILEM contactors

Rated operational current	Max. motor rating for three-phase motors, 50 - 60 Hz						Conventional thermal current $I_{th} = I_e$ AC-1 at 50 °C		Contact	Circuit symbol	For use with
	AC-3			AC-4			Open	Enclosed			
380 V 400 V	220 V 230 V	380 V 400 V	660 V 690 V	220 V 230 V	380 V 400 V	660 V 690 V	$I_{th} = I_e$	$I_{th} = I_e$	N/O = normally open contact NC = normally closed contact		
I_e	P	P	P	P	P	P	A	A			

3 pole with auxiliary contact
Screw terminals



6.6	1.5	3	3	1.1	2.2	2.2	20	16	1 N/O	–		...DILEM DILE...
6.6	1.5	3	3	1.1	2.2	2.2	20	16	–	1 NC		DILE...
9	2.2	4	4	1.5	3	3	20	16	1 N/O	–		...DILEM DILE...
9	2.2	4	4	1.5	3	3	20	16	–	1 NC		DILE...
12	3.5	5.5	6.5	2	3	2.2	20	16	1 N/O	–		...DILEM DILE...
12	3.5	5.5	6.5	2	3	2.2	20	16	–	1 NC		DILE...
9	2.2	4	4	1.5	3	3	20	16	–	–		...DILEM DILE...

4 pole
Screw terminals



1)

Information relevant for export to North America



Product Standards	IEC/EN 60947-4-1; UL 508; CSA-C22.2 No.14-05; CE marking
UL File No.	E29096
UL CC	NLDX
CSA File No.	012528
CSA Class No.	3211-04
NA Certification	UL Listed, CSA certified
See also	→ Page 80



2)

Information relevant for export to North America



Product Standards	IEC/EN 60947-4-1; UL 508; CSA-C22.2 No.14-05; CE marking
UL File No.	E29096
UL CCN	NLDX
CSA File No.	012528
CSA Class No.	2411-03,3211-04
NA Certification	UL Listed, request filed for CSA

AC operation		DC operation			
Part no.	Price	Part no.	Price	Std. pack	Notes
Article no.	See price list	Article no.	See price list		

DILEEM-10(230V50HZ)¹⁾ 051608	DILEEM-10-G(24VDC)¹⁾ 051643	5 off 
DILEEM-01(230V50HZ)¹⁾ 051633	DILEEM-01-G(24VDC)¹⁾ 051650	
DILEM-10(230V50HZ)¹⁾ 051786	DILEM-10-G(24VDC)¹⁾ 010213	
DILEM-01(230V50HZ)¹⁾ 051795	DILEM-01-G(24VDC)¹⁾ 010343	
DILEM12-10(230V50HZ)²⁾ 127075	DILEM12-10-G(24VDC)²⁾ 127132	
DILEM12-01(230V50HZ)²⁾ 127091	DILEM12-01-G(24VDC)²⁾ 127137	
DILEM4(230V50HZ)¹⁾ 051804	DILEM4-G(24VDC)¹⁾ 012701	5 off 

With screw terminals:

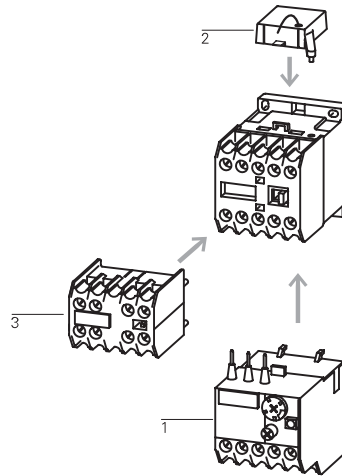

Accessories

1 Overload relay

2 Suppressor

3 Auxiliary contact module

Enclosures totally insulated

Further actuating voltages

Accessories

Page

→ Chapter 2

→ 8

→ 6

→ 66

→ 8

1.1

Mini contactor relays Auxiliary contact modules



1 Screw terminals











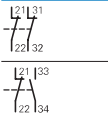

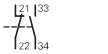

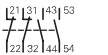

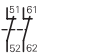

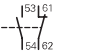





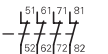

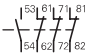

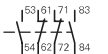
DILE Auxiliary contact modules

	Contact				Rated operational current		Conventional thermal current I_{th} A	Distinctive number/type of combinations with basic device		
	N/O	S _F	NC	Ö _S	AC-15 220 V 230 V 240 V	380 V 400 V 415 V		DILER-40(-G)	DILER-31(-G)	DILER-22
2 pole	–	–	2 NC	–	4	2	10	–	–	–
	1 N/O	–	1 NC	–	4	2	10	–	–	–
4 pole	2 N/O	–	2 NC	–	4	2	10	–	–	–
2 pole	–	–	2 NC	–	4	2	10	42E	33	24
	1 N/O	–	1 NC	–	4	2	10	51E	42	33
	2 N/O	–	–	–	4	2	10	60E	51	42
4 pole	–	1 S _F	–	1 Ö _S	4	2	10	51	42	33
	–	–	4 NC	–	4	2	10	44E	35	26
	1 N/O	–	3 NC	–	4	2	10	53E	44	35
	2 N/O	–	2 NC	–	4	2	10	62E	53	44
	3 N/O	–	1 NC	–	4	2	10	71E	62	53
4 pole	4 N/O	–	–	–	4	2	10	80E	71	62
	1 N/O	1 S _F	1 NC	1 Ö _S	4	2	10	62	53	44

Information relevant for export to North America

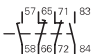
 	Product Standards	IEC/EN 60947-4-1; UL 508; CSA-C22.2 No.14-05; CE marking
	UL File No.	E29184
	UL CCN	NKCR
	CSA File No.	012528
	CSA Class No.	3211-03
	NA Certification	UL Listed, CSA certified

Circuit symbol	Can be combined with contactor	Part no. Article no.	Price See price list	Std. pack	Notes	
		02DILEM 010064		5 off 	With interlocked opposing contacts	The following applies to ...DILEM auxiliary contacts: • Contacts to EN 50012 The following applies to ...DILE auxiliary contacts: • Contacts to EN 50005
		11DILEM 010080		5 off 	With interlocked opposing contacts	
		22DILEM 010112		5 off 	With interlocked opposing contacts	Contacts according to EN50012 are to be preferred. Type E combinations comply with EN 50011 and are to be given preference.
		02DILE 010240		5 off 	With interlocked opposing contacts	
		11DILE 010224		5 off 	With interlocked opposing contacts	No interlocked opposing contacts in NO early-makes and NC late-breaks.
		20DILE 010208		5 off 	With interlocked opposing contacts	
		11DDILE 049824		5 off 	—	
		04DILE 010256		5 off 	With interlocked opposing contacts	
		13DILE 002397		5 off 	With interlocked opposing contacts	
		22DILE 010288		5 off 	With interlocked opposing contacts	
		31DILE 048912		5 off 	With interlocked opposing contacts	
		40DILE 010304		5 off 	With interlocked opposing contacts	
		22DDILE 049823		5 off 	—	

1.1

Mini contactor relays Accessories

1 VGDILE..., RCDILE..., MVDILE, BT480, P1DILEM

	Actuating voltage U_s V AC	Circuit symbol	For use with	Part no. Article no.	Price See price list	Std. pack	Information relevant for export to North America
Suppressor circuits							
Varistor suppressor							
	24 - 48 AC		DILE...	VGDILE48 010320	10 off		Product Standards IEC/EN 60947-4-1; UL 508; CSA-C22.2 No.14-05; CE marking UL File No. UL CCN CSA File No. CSA Class No. NA Certification
	110 - 250 AC			VGDILE250 010336	10 off		
	380 - 415 AC			VGDILE415 010463	10 off		
RC-Suppressor							
	24 - 48 AC		DILE...	RCDILE48 044264	10 off		Product Standards IEC/EN 60947-4-1; UL 508; CSA-C22.2 No.14-05; CE marking UL File No. UL CCN CSA File No. NA Certification
	110 - 250 AC			RCDILE250 046320	10 off		
Notes For AC operated contactors 50 - 60 Hz. DC operated contactor relays have an integrated suppressor. Note drop-out delay.							

VGDILE..., RCDILE..., MVDILE, BT480, P1DILEM

			For use with	Part no. Article no.	Price See price list	Std. pack	Information relevant for export to North America
Mechanical interlocks							
For mechanical connection of contactor and timing relays in combinations. 0 mm distance between contactors.							
			DILE... DILET...	VODILE 026634	50 off		UL/CSA certification not required
Mechanical interlock							
For contactors with the same or different magnet system. 0 mm distance between contactors. Mechanical lifespan 2.5 x 10 ⁶ operations. Additional auxiliary contact modules possible.							
			DILE...	MVDILE 010113	5 off		Product Standards IEC/EN 60947-4-1; UL 508; CSA-C22.2 No.14-05; CE marking UL File No. UL CCN CSA File No. CSA Class No. NA Certification
Paralleling link							
For parallel connection of contacts							
			DILE... DILE...	BT480 ¹⁾ 052785	100 off		Product Standards IEC/EN 60947-4-1; UL 508; CSA-C22.2 No.14-05; CE marking UL File No. UL CCN CSA File No. CSA Class No. NA Certification
Consisting of two four-pole paralleling links.							
			DILEEM DILEM12 DILEM	P1DILEM ²⁾ 019095	5 off		UL Listed, CSA certified
Notes							
1) Not protected against accidental contact as specified in VDE 0106 Part 100.							
2) 4th pole can be broken off 4 pole: I _{th} = 60 A open 3 pole: I _{th} = 50 A open AC-1 current carrying capacity of the open contactor increases by a factor of 2.5 Protected against accidental contact in accordance with VDE 0106 Part 100							

HDILE, ...DILEM, MVS

Contact sequence

For use with

Part no.
Article no.

Price
See price list

Std. pack

Information relevant for export to North America



Sealable shrouds

Transparent
Snap-fitting on contactor.
Can be used with open installation or on service distribution board.
Protection type: IP40 front
Can be drilled to accommodate timing relay setting dials.

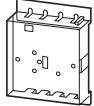

DILE...
DILET...

HDILE
010482

1 off

UL/CSA certification not required

Start-point bridge



DILEEM
DILEM12
DILEM

S1DILEM¹⁾
220218

20 off

Reversing starter wiring kit

Main current wiring for reversing combinations

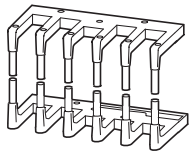

DILEEM (+MVDILEM)
DILEM12 (+MVDILEM)
DILEM (+MVDILEM)

MVS-WB-EM²⁾
220209

1 off

Product Standards IEC/EN 60947-4-1; UL 508;
CSA-C22.2 No.14-05;
CE marking
UL File No. E36332
UL CCN NLRV7
CSA File No. 012528
CSA Class No. 3211-06
NA Certification UL Listed, CSA certified

Star-delta wiring kit

Main current wiring for star-delta combination incl. star-point bridge

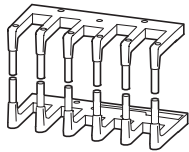

DILE(E)M (+MVDILEM)
DILE(E)M12 (+MVDILEM)
DILE(E)M star contactor

MVS-SB-EM³⁾
220213

1 off

Product Standards IEC/EN 60947-4-1; UL 508;
CSA-C22.2 No.14-05;
CE marking
UL File No. E36332
UL CCN NLRV7
CSA File No. 012528
CSA Class No. 3211-06
NA Certification UL Listed, CSA certified

Notes

- ¹⁾ Protected against accidental contact in accordance with VDE 0106 Part 100
²⁾ The following control cables are integrated in addition to electrical interlock:
- Q11: A1 - Q12: 21
 - Q11: 21 - Q12: A1
 - Q11: A2 - Q12: A2
- For use with overload relay separate mounting.
- ³⁾ The following control cables are integrated in addition to electrical interlock:
- Q13: A1 - Q15: 21
 - Q13: 21 - Q15: A1
 - Q13: A2 - Q15: A2
- For use with overload relay separate mounting.

1.1

Contactor relays

Basic devices

1

DILA Basic devices with positively driven contacts

Contact		Rated operational current		Conventional thermal current	Distinctive number	Can be combined with auxiliary contact	Circuit symbol
N/O = normally open contact	NC = normally closed contact	AC-15		I_{th}			
		220 V	380 V	A	40E	DILA-XHI(V)...	
		230 V	400 V				
		240 V	415 V				
		I_e	I_e				
		A	A				

Screw terminals

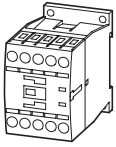

4 N/O	–	4	4	16	40E	DILA-XHI(V)...	
3 N/O	1 NC	4	4	16	31E	DILA-XHI(V)...	
2 N/O	2 NC	4	4	16	22E	DILA-XHI(V)...	

Spring-loaded terminals

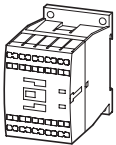

4 N/O	–	4	4	16	40E	DILA-XHIC(V)...	
3 N/O	1 NC	4	4	16	31E	DILA-XHIC(V)...	
2 N/O	2 NC	4	4	16	22E	DILA-XHIC(V)...	

Notes
 Contact numbers to EN 50011
 Coil terminal markings to EN 50005
 The following applies to DC-operated contactors:

- Integrated suppressor circuit

Information relevant for export to North America



Product Standards	IEC/EN 60947-4-1; UL 508; CSA-C22.2 No.14-05; CE marking
UL File No.	E29184
UL CCN	NKCR
CSA File No.	012528
CSA Class No.	3211-03
NA Certification	UL Listed, CSA certified

AC operation

Part no.
Article no.

Price
See price list

Std. pack

Circuit symbol

DC operation

Part no.
Article no.

Price
See price list

Std. pack

Notes

DILA-40(230V50HZ) 276329	1 off 		DILA-40(24VDC) 276344	1 off
DILA-31(230V50HZ) 276364	1 off 		DILA-31(24VDC) 276379	
DILA-22(230V50HZ) 276399	1 off 		DILA-22(24VDC) 276414	

With screw terminals:

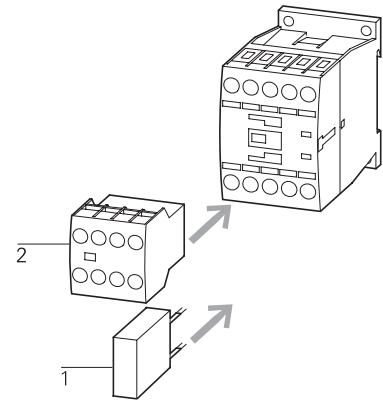

Accessories

- 1 Suppressor
- 2 Auxiliary contact modules
- Further actuating voltages

Page

- 50
- 36
- 68

DILAC-40(230V50HZ) 276441	1 off 		DILAC-40(24VDC) 276456	1 off
DILAC-31(230V50HZ) 276473	1 off 		DILAC-31(24VDC) 276488	
DILAC-22(230V50HZ) 276505	1 off 		DILAC-22(24VDC) 276520	

With spring-loaded terminals:

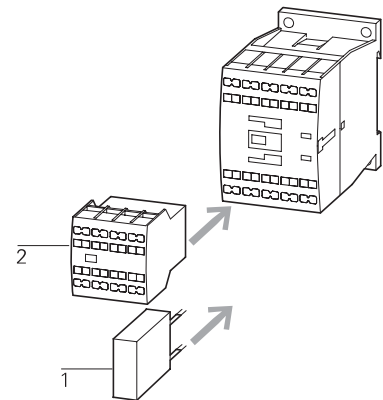



























Accessories

- 1 Suppressor
- 2 Auxiliary contact modules
- Further actuating voltages

Page

- 50
- 36
- 68









































DILA...XHI... DILA auxiliary contact modules

	Contact	Rated operational current		Conventional thermal current	Circuit symbol					
		AC-15								
	N/O = normally open contact S _F = NO early-make NC = normally closed contact Ö _S = NC late-break	220 V	380 V	I _{th}						
		230 V	400 V							
		240 V	415 V							
		I _b	I _e	A						
		A	A	A						
Screw terminals 	2 pole	–	–	2 NC	–	4	4	16		
		1 N/O	–	1 NC	–	4	4	16		
		2 N/O	–	–	–	4	4	16		
		–	1 S _F	–	1 Ö _S	–	4	4	16	
Screw terminals 	4 pole	–	–	4 NC	–	4	4	16		
		1 N/O	–	3 NC	–	4	4	16		
		2 N/O	–	2 NC	–	4	4	16		
		3 N/O	–	1 NC	–	4	4	16		
		4 N/O	–	–	–	4	4	16		
		1 N/O	1 S _F	1 NC	1 Ö _S	–	4	4	16	
		–	–	–	–	–	4	4	16	
Spring-loaded terminals 	2 pole	–	–	2 NC	–	4	4	16		
		1 N/O	–	1 NC	–	4	4	16		
		2 N/O	–	–	–	4	4	16		
		–	1 S _F	–	1 Ö _S	–	4	4	16	
Spring-loaded terminals 	4 pole	–	–	4 NC	–	4	4	16		
		1 N/O	–	3 NC	–	4	4	16		
		2 N/O	–	2 NC	–	4	4	16		
		3 N/O	–	1 NC	–	4	4	16		
		4 N/O	–	–	–	4	4	16		
		1 N/O	1 S _F	1 NC	1 Ö _S	–	4	4	16	
		–	–	–	–	–	4	4	16	

Information relevant for export to North America



Product Standards	IEC/EN 60947-4-1; UL 508; CSA-C22.2 No.14-05; CE marking
UL File No.	E29184
UL CCN	NKCR
CSA File No.	012528
CSA Class No.	3211-03
NA Certification	UL Listed, CSA certified

Distinctive number/type of combinations			Part no. Article no.	Price See price list	Std. pack	Description	Notes
DILA(C)-40	DILA(C)-31	DILA(C)-22					
42E	33	24	DILA-XHI02 276420		5 off  	With interlocked opposing contacts	Type E combinations comply with EN 50011 and must be given preference. The other combinations comply with EN 50005 The DC operated contactor DILA(C)-22 must only be combined with 2 pole auxiliary contacts.
51E	42	33	DILA-XHI11 276421		5 off  	With interlocked opposing contacts	
60E	51	42	DILA-XHI20 276422		5 off  	With interlocked opposing contacts	
51	42	33	DILA-XHIV11 276423		5 off  	—	
44E	35	26	DILA-XHI04 276424		5 off  	With interlocked opposing contacts	
53E	44	35	DILA-XHI13 276425		5 off  	With interlocked opposing contacts	
62E	53	44	DILA-XHI22 276426		5 off  	With interlocked opposing contacts	
71E	62	53	DILA-XHI31 276427		5 off  	With interlocked opposing contacts	
80E	71	62	DILA-XHI40 276428		5 off  	With interlocked opposing contacts	
62	53	44	DILA-XHIV22 276429		5 off  	—	
42E	33	24	DILA-XHIC02 276526		5 off  	With interlocked opposing contacts	Type E combinations comply with EN 50011 and must be given preference. The other combinations comply with EN 50005 The DC operated contactor DILA(C)-22 must only be combined with 2 pole auxiliary contacts.
51E	42	33	DILA-XHIC11 276527		5 off  	With interlocked opposing contacts	
60E	51	42	DILA-XHIC20 276528		5 off  	With interlocked opposing contacts	
51	42	33	DILA-XHICV11 276529		5 off  	—	
44E	35	26	DILA-XHIC04 276530		5 off  	With interlocked opposing contacts	
53E	44	35	DILA-XHIC13 276531		5 off  	With interlocked opposing contacts	
62E	53	44	DILA-XHIC22 276532		5 off  	With interlocked opposing contacts	
71E	62	53	DILA-XHIC31 276533		5 off  	With interlocked opposing contacts	
80E	71	62	DILA-XHIC40 276534		5 off  	With interlocked opposing contacts	
62	53	44	DILA-XHICV22 276535		5 off  	—	

1.2 Contactors

1 Technical overview

DILM, DILE(E)M, DILMP

Contactors
3 pole

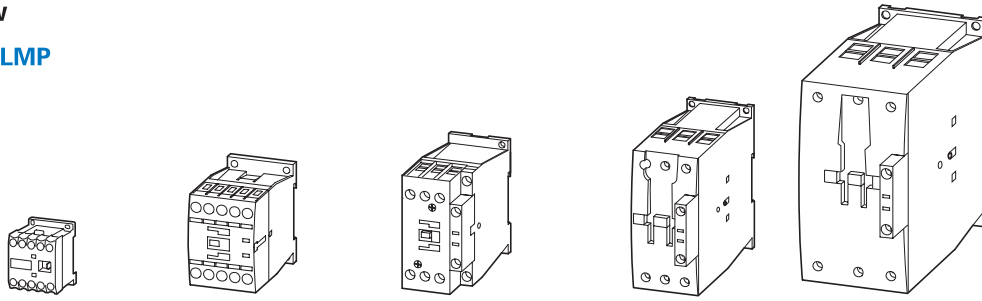

DIL	EEM	EM	EM12	M7	M9	M12	M15	M17	M25	M32	M38	M40	M50	M65	M80	M95	M115	M150	M170
Basic devices	Page → 4			→ 18				→ 18				→ 20			→ 46				
Complete units	Page	–		→ Page 24		–		→ Page 24				→ Page 26			→ Page 26				
Rated-operational voltage	kW	kW	kW	kW	kW	kW	kW	kW	kW	kW	kW	kW	kW	kW	kW	kW	kW	kW	kW

AC-3

Rated operational power
for 3-phase motors 50–60 Hz

220 V – 230 V	1.5	2.2	3	2.2	2.5	3.5	4	5	7.5	10	11	12.5	15.5	20	25	30	37	48	52
380 V – 400 V	3	4	5.5	3	4	5.5	7.5	7.5	11	15	18.5	18.5	22	30	37	45	55	75	90
440 V	3.3	4.6	5.5	4.5	5.5	7.5	8.4	10.5	15.5	20	21	25	32	41	51	60	75	95	105
500 V	3	4	5.5	3.5	4.5	7	7.5	12	17.5	23	24	28	36	47	58	70	85	110	120
660 V/690 V	3	4	4	3.5	4.5	6.5	7	11	14	17	21	23	30	35	63	75	90	96	140
1000 V	–	–	–	–	–	–	–	–	–	–	–	–	–	–	–	–	–	–	–

AC-4

Rated operational power
for 3-phase motors 50–60 Hz

▲ Increase in life span for DILM7 – DILM150 to 200000 operations

220 V – 230 V	1.1	1.5	1.5	1	1.5	2	2	2.5	3.5	4	4	5	6	7	12	16	17	20	20
380 V – 400 V	2.2	3	3	2.2	2.5	3	3	4.5	6	7	7	9	10	12	20	26	28	33	33
440 V	2.4	3.3	3.3	2.4	3	3.6	3.6	5.5	7	8	8	10	12	14	25	32	35	41	41
500 V	2.2	3	3	2.5	2.8	3.5	3.5	6	8	9	9	11	13	16	29	36	40	47	47
660 V/690 V	2.2	3	3	2.9	3.6	4.4	4.4	6.5	8.5	10	10	12	14	17	26	35	43	48	48
1000 V	–	–	–	–	–	–	–	–	–	–	–	–	–	–	–	–	–	–	–

AC-1

Rated operational power under resistive load, 40 °C

220 V – 230 V	8	8	8	8	8	8	8	15	17	17	17	22	30	37	42	49	61	72	85
380 V – 400 V	13	13	13	14	14	14	14	26	29	29	29	39	53	65	72	85	105	125	150
440 V	15	15	15	16	16	16	16	30	34	34	34	45	58	71	80	94	116	138	170
500 V	18	18	18	19	19	19	19	34	38	38	38	51	66	81	90	107	132	156	194
660 V/690 V	23	23	23	25	25	25	25	45	51	51	51	68	91	111	125	148	182	216	268
1000 V	–	–	–	–	–	–	–	–	–	–	–	–	–	–	–	–	–	–	–

Conventional thermal

Current

$I_{th} = I_{\theta}$ open at 40 °C

	A	A	A	A	A	A	A	A	A	A	A	A	A	A	A	A	A	A	A
	22	22	22	22	22	22	22	40	45	45	45	60	80	98	110	130	160	190	225

DILM, DILE(E)M, DILMP

Contactors
4 pole

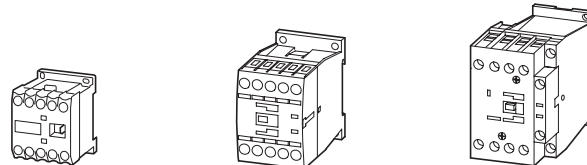

DIL	EM4	MP20	MP32
Rated operational voltage	Page → 4	→ Page 34	→ Page 34
AC-1			
Conventional free air thermal current $I_{th} = I_{\theta}$ open, at 40 °C	A	A	A
up to 690 V	22	22	32

DILM, DILH, DILMP

3 pole

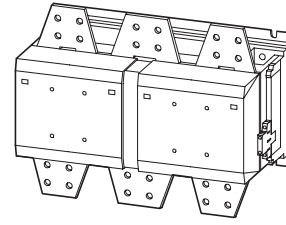
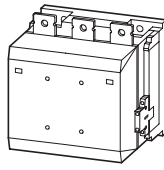
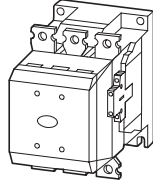
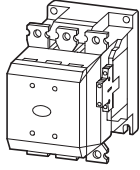
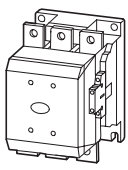

M185A M225A M250 M300A M400 M500 M580 M650 M750 M820 M1000 M1600 H1400 H2000 H2200 H2600

→ Page 30 → Page 30 → Page 30 → Page 30 → Page 32

kW kW kW kW kW kW kW kW kW kW kW kW kW kW kW

55	70	75	90	125	155	185	205	240	260	315	500	-	-	-	-
90	110	132	160	200	250	315	355	400	450	560	900	-	-	-	-
115	142	157	190	255	345	370	420	480	525	650	1000	-	-	-	-
132	160	180	215	290	360	420	470	550	600	730	1180	-	-	-	-
175	215	240	286	344	344	560	630	720	750	1000	1600	-	-	-	-
108	108	108	132	132	132	600	600	800	800	1000	1770	-	-	-	-

41	51	62	75	92	112	143	161	181	209	260	430	-	-	-	-
75	90	110	132	160	200	250	280	315	355	450	750	-	-	-	-
85	102	125	140	186	229	290	326	367	418	520	830	-	-	-	-
96	116	143	172	214	260	330	370	417	474	590	940	-	-	-	-
127	155	189	229	283	344	440	494	556	633	780	1300	-	-	-	-
108	108	108	132	132	132	509	509	678	678	1000	1650	-	-	-	-

121	139	155	177	221	310	354	376	398	443	443	717	620	886	1075	1269
210	241	268	306	382	535	612	650	689	766	766	1247	1071	1531	1870	2207
243	279	310	354	443	620	709	753	797	886	886	1371	1240	1773	2058	2427
277	317	352	403	503	705	806	856	906	1007	1007	1558	1410	2015	2338	2758
365	419	465	532	664	930	1064	1130	1196	1330	1330	2151	1861	2660	3227	3806
554	635	705	806	1007	1410	1612	1712	1813	2015	2015	2420	2417	3223	4676	5516

A A A A A A A A A A A A A A A

337 356 400 430 612 857 980 1041 1102 1225 1225 2200 1714 2450 2700 3185

DILM, DILE(E)M, DILMP

4 pole

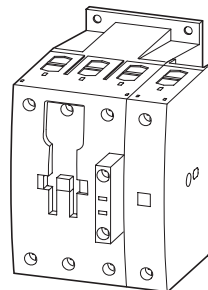
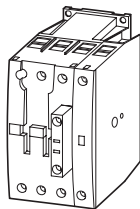

MP45 MP63 MP80 MP125 MP160 MP200

→ Page 34 → Page 34 → Page 34

A	A	A	A	A	A
45	63	80	125	160	200

1.3 Contactors

1 System overview

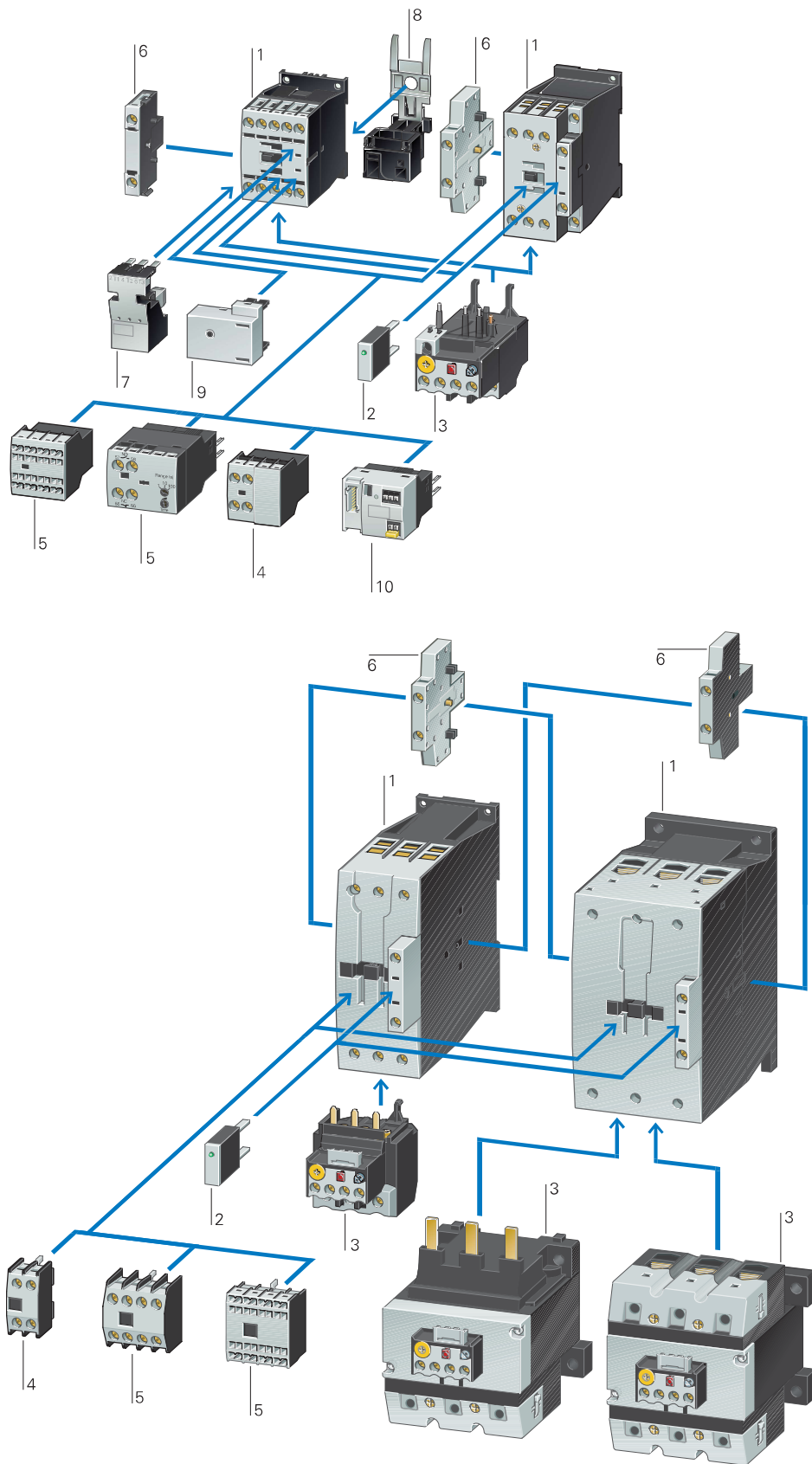

DILM7...DILM170

Contactors up to 90 kW (AC-3/400V) 1

3 pole

→ Page 18

4 pole

→ Page 34

Suppressor circuits 2

→ Page 50

Overload relays 3

→ Page 8

Auxiliary contact modules 4

→ Page 36

Auxiliary contact modules 5

→ Page 36

Auxiliary contact modules 6

→ Page 39

Motor feeder plug 7

→ Page 58

PE module with contact plate 8

→ Page 58

Motor suppressor module 9

→ Page 59

SmartWire-Darwin contactor module 10

→ Page 58

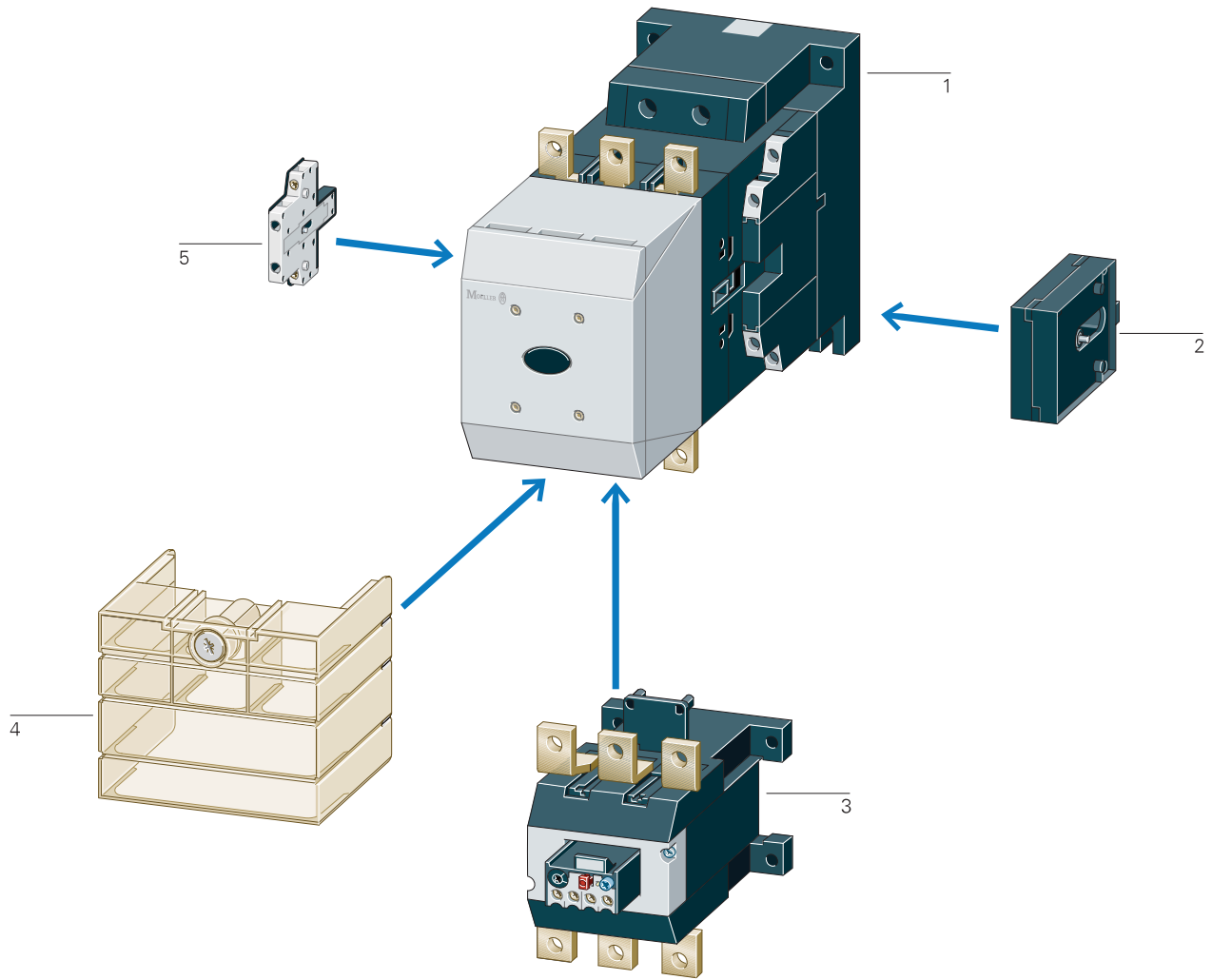

DILM185... DILH2600

Contactors 90 – 900 kW (AC-3/400 V) Comfort series	1
→ Page 30	
Standard range 90–250kW	1
→ Page 28	

Mechanical interlock	2
→ Page 52	
Overload relays	3
→ Page 12	

Terminal shroud	4
→ Page 61	
Auxiliary contact modules	5
→ Page 39	

1.4

Contactors

Basic devices up to 170 A

1

DILM Basic device

Rated operational current

Max. motor rating for three-phase motors 50 - 60 Hz

Conventional thermal current $I_{th} = I_e$ AC-1 at 60 °C

Contact configuration

Circuit symbol

AC-3	AC-3		AC-4		AC-4		Open	$I_{th} = I_e$	Contact configuration	Circuit symbol
380 V 400 V	220 V 230 V	380 V 400 V	660 V 690 V	220 V 230 V	380 V 400 V	660 V 690 V				
7	2.2	3	3.5	1	2.2	2.9	20	1 N/O	—	
7	2.2	3	3.5	1	2.2	2.9	20	—	1 NC	
9	2.5	4	4.5	1.5	2.5	3.6	20	1 N/O	—	
9	2.5	4	4.5	1.5	2.5	3.6	20	—	1 NC	
12	3.5	5.5	6.5	2	3	4.4	20	1 N/O	—	
12	3.5	5.5	6.5	2	3	4.4	20	—	1 NC	
15.5	4	7.5	7	2	3	4.4	20	1 N/O	—	
15.5	4	7.5	7	2	3	4.4	20	—	1 NC	
18	5	7.5	11	2.5	4.5	6.5	35	1 N/O	—	
18	5	7.5	11	2.5	4.5	6.5	35	—	1 NC	
25	7.5	11	14	3.5	6	8.5	40	1 N/O	—	
25	7.5	11	14	3.5	6	8.5	40	—	1 NC	
32	10	15	17	4	7	10	40	1 N/O	—	
32	10	15	17	4	7	10	40	—	1 NC	
38	11	18.5	21	4	7	10	40	1 N/O	—	
38	11	18.5	21	4	7	10	40	—	1 NC	

Screw terminals
3 pole

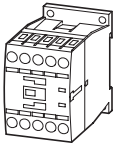

Screw terminals
3 pole

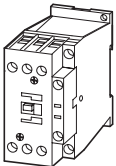

Information relevant for export to North America



Product Standards IEC/EN 60947-4-1; UL 508; CSA-C22.2 No.14-05; CE marking
 UL File No. E29096
 UL CCN NLDX
 CSA File No. 012528
 CSA Class No. 2411-03, 3211-04
 NA Certification UL Listed, CSA certified
 See also → Page 80

Can be combined with auxiliary contact	AC operation	DC operation			
	Part no. Article no.	Price See price list	Part no. Article no.	Price See price list	Std. pack
					Notes

DILM32-XHI.. DILA-XHI(V)..	DILM7-10(230V50HZ) 276550	DILM7-10(24VDC) 276565	1 off 
DILA-XHI(V)..	DILM7-01(230V50HZ) 276585	DILM7-01(24VDC) 276600	
DILM32-XHI.. DILA-XHI(V)..	DILM9-10(230V50HZ) 276690	DILM9-10(24VDC) 276705	
DILA-XHI(V)..	DILM9-01(230V50HZ) 276725	DILM9-01(24VDC) 276740	
DILM32-XHI.. DILA-XHI(V)..	DILM12-10(230V50HZ) 276830	DILM12-10(24VDC) 276845	
DILA-XHI(V)..	DILM12-01(230V50HZ) 276865	DILM12-01(24VDC) 276880	
DILM32-XHI.. DILA-XHI(V)..	DILM15-10(230V50HZ)¹⁾ 290058	DILM15-10(24VDC)¹⁾ 290073	
DILA-XHI(V)..	DILM15-01(230V50HZ)¹⁾ 290093	DILM15-01(24VDC)¹⁾ 290108	
DILM32-XHI.. DILA-XHI(V).. DILM32-XHI11-S	DILM17-10(230V50HZ) 277004	DILM17-10(RDC24) 277018	
DILA-XHI(V).. DILM32-XHI11-S	DILM17-01(230V50HZ) 277036	DILM17-01(RDC24) 277050	
DILM32-XHI.. DILA-XHI(V).. DILM32-XHI11-S	DILM25-10(230V50HZ) 277132	DILM25-10(RDC24) 277146	
DILA-XHI(V).. DILM32-XHI11-S	DILM25-01(230V50HZ) 277164	DILM25-01(RDC24) 277178	
DILM32-XHI.. DILA-XHI(V).. DILM32-XHI11-S	DILM32-10(230V50HZ) 277260	DILM32-10(RDC24) 277274	
DILA-XHI(V).. DILM32-XHI11-S	DILM32-01(230V50HZ) 277292	DILM32-01(RDC24) 277306	
DILM32-XHI.. DILA-XHI(V).. DILM32-XHI11-S	DILM38-10(230V50HZ)¹⁾ 112428	DILM38-10(RDC24)¹⁾ 112442	
DILA-XHI(V).. DILM32-XHI11-S	DILM38-01(230V50HZ)¹⁾ 112456	DILM38-01(RDC24)¹⁾ 112470	

Contacts to EN 50 012.
For all DC operated contactors DILM7 - DILM15 the following applies:

- Integrated varistor-suppressor circuit.

For DC operated contactors DILM17 - DILM170 the following applies:

- Integrated suppressor circuit in actuating electronics

For AC operated contactors DILM115 - DILM170 the following applies:

- Integrated suppressor circuit in actuating electronics
- With mirror contact.

¹⁾ Electrical lifespan → 87

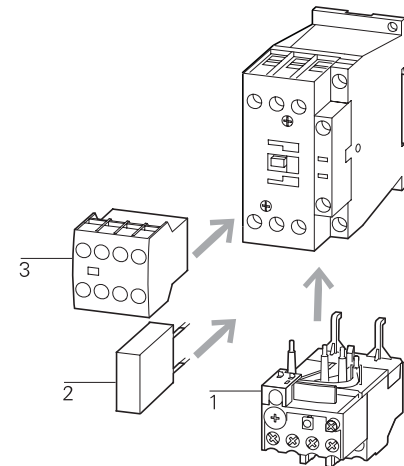

Accessories	Page
1 Overload relay	→ Chapter 2
2 Suppressor	→ 50
3 Auxiliary contact module	→ 36
Further actuating voltages	→ 69
Accessories	→ 52

1.4

Contactors

Basic devices up to 170 A

1

DILM Basic device

Rated operational current

Max. motor rating for three-phase motors 50 - 60 Hz

Conventional thermal current $I_{th} = I_e$ AC-1 at 60 °C

Contact configuration

Circuit symbol

AC-3	AC-3			AC-4			Open
380 V 400 V	220 V 230 V	380 V 400 V	660 V 690 V	220 V 230 V	380 V 400 V	660 V 690 V	

N/O = normally open contact
NC = normally closed contact

I_e A	P kW	P kW	P kW	P kW	P kW	P kW	$I_{th} = I_e$ A
40	12.5	18.5	23	5	9	12	50

Screw terminals
3 pole

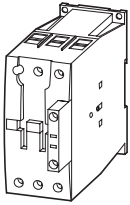

50	15.5	22	30	6	10	14	65
-----------	------	-----------	----	---	-----------	----	----

65	20	30	35	7	12	17	80
-----------	----	-----------	----	---	-----------	----	----

72	25	37	35	7	12	17	80
-----------	----	-----------	----	---	-----------	----	----

80	25	37	63	12	20	26	90
-----------	----	-----------	----	----	-----------	----	----

95	30	45	75	16	26	35	110
-----------	----	-----------	----	----	-----------	----	-----

115	37	55	90	17	28	43	130
------------	----	-----------	----	----	-----------	----	-----

150	48	75	96	20	33	48	160
------------	----	-----------	----	----	-----------	----	-----

170	52	90	140	20	33	48	185
------------	----	-----------	-----	----	-----------	----	-----



Screw terminals
3 pole

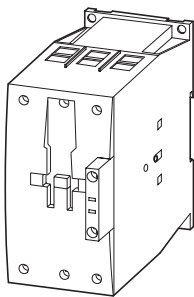

Information relevant for export to North America



Product Standards	IEC/EN 60947-4-1; UL 508; CSA-C22.2 No.14-05; CE marking
UL File No.	E29096
UL CCN	NLDX
CSA File No.	012528
CSA Class No.	2411-03, 3211-04
NA Certification	UL Listed, CSA certified
See also	→ Page 80

Can be combined with auxiliary contact

AC operation	DC operation
Part no. Article no.	Part no. Article no.
Price See price list	Price See price list

AC operation	DC operation	
Part no. Article no.	Part no. Article no.	
Price See price list	Price See price list	
DILM150-XHI(V).. DILM1000-XHI(V)..	DILM40(230V50HZ) 277766	DILM40(RDC24) 277780
DILM150-XHI(V).. DILM1000-XHI(V)..	DILM50(230V50HZ) 277830	DILM50(RDC24) 277844
DILM150-XHI(V).. DILM1000-XHI(V)..	DILM65(230V50HZ) 277894	DILM65(RDC24) 277908
DILM150-XHI(V).. DILM1000-XHI(V)..	DILM72(230V50HZ)¹⁾ 107670	DILM72(RDC24)¹⁾ 107671
DILM150-XHI(V).. DILM1000-XHI(V)..	DILM80(230V50HZ) 239402	DILM80(RDC24) 239416
DILM150-XHI(V).. DILM1000-XHI(V)..	DILM95(230V50HZ) 239480	DILM95(RDC24) 239510
DILM150-XHI(V).. DILM1000-XHI(V)..	DILM115(RAC240) 239548	DILM115(RDC24) 239555
DILM150-XHI(V).. DILM1000-XHI(V)..	DILM150(RAC240) 239588	DILM150(RDC24) 239591
DILM150-XHI(V).. DILM1000-XHI(V)..	DILM170(RAC240)¹⁾ 107013	DILM170(RDC24)¹⁾ 107016

1 off

Contacts to EN 50012.
 For all DC operated contactors DILM7 - DILM15 the following applies:
 • Integrated varistor-suppressor circuit.
 For DC operated contactors DILM17 - DILM170 the following applies:
 • Integrated suppressor circuit in actuating electronics
 For AC operated contactors DILM115 - DILM170 the following applies:
 • Integrated suppressor circuit in actuating electronics
 For DILM7-01 – DILM38-01 the following applies:
 • With mirror contact.

¹⁾ Electrical lifespan → 87

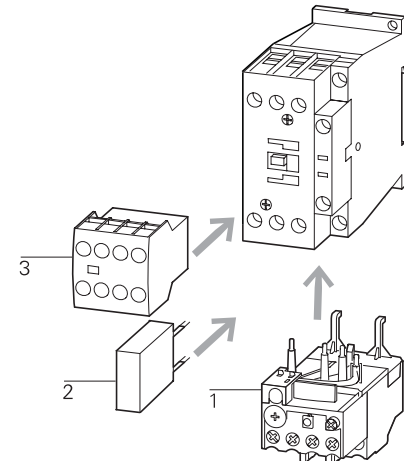

Accessories	Page
1 Overload relay	→ Chapter 2
2 Suppressor	→ 50
3 Auxiliary contact module	→ 36
Further actuating voltages	→ 71
Accessories	→ 52

1.4

Contactors

Basic devices up to 170 A

1

DILM Basic device

Rated operational current AC-3	Max. motor rating for three-phase motors 50 - 60 Hz						Conventional thermal current $I_{th} = I_e$ AC-1 at 60 °C	Contact configuration	Circuit symbol	
	AC-3		AC-4		AC-4					
380 V 400 V I_e A	220 V P kW	380 V 400 V P kW	660 V P kW	220 V P kW	380 V 400 V P kW	660 V P kW	Open $I_{th} = I_e$ A	N/O = normally open contact NC = normally closed contact		
7	2.2	3	3.5	1	2.2	2.9	20	1 N/O	—	
7	2.2	3	3.5	1	2.2	2.9	20	—	1 NC	
9	2.5	4	4.5	1.5	2.5	3.6	20	1 N/O	—	
9	2.5	4	4.5	1.5	2.5	3.6	20	—	1 NC	
12	3.5	5.5	6.5	2	3	4.4	20	1 N/O	—	
12	3.5	5.5	6.5	2	3	4.4	20	—	1 NC	
15.5	4	7.5	7	2	3	4.4	20	1 N/O	—	
15.5	4	7.5	7	2	3	4.4	20	—	1 NC	
18	5	7.5	11	2.5	4.5	6.5	35	1 N/O	—	
18	5	7.5	11	2.5	4.5	6.5	35	—	1 NC	
25	7.5	11	14	3.5	6	8.5	40	1 N/O	—	
25	7.5	11	14	3.5	6	8.5	40	—	1 NC	
32	10	15			7	10	40	1 N/O	—	
32	10	15			7	10	40	—	1 NC	
40	12.5	18.5			9	12	50	—	—	
50	15.5	22			10	14	65	—	—	
65	20	30			12	17	80	—	—	
80	25	37	63	12	20	26	90	—	—	
95	30	45	75	16	26	35	110	—	—	
115	37	55	90	17	28	43	130	—	—	
150	48	75	96	20	33	48	160	—	—	

Spring-loaded terminals
3 pole

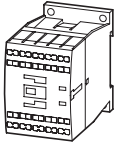

Spring-loaded terminals on
auxiliary and control circuit
terminals
3 pole

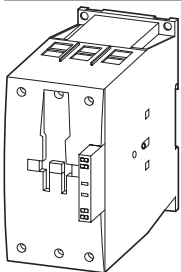
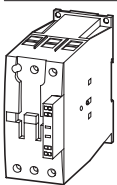
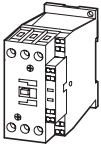

Information relevant for export to North America



Product Standards	IEC/EN 60947-4-1; UL 508; CSA-C22.2 No.14-05; CE marking
UL File No.	E29096
UL CCN	NLDX
CSA File No.	012528
CSA Class No.	2411-03, 3211-04
NA Certification	UL Listed, CSA certified
See also	→ Page 80

Can be combined with auxiliary contact

	AC operation		DC operation		Std. pack	Notes
	Part no. Article no.	Price See price list	Part no. Article no.	Price See price list		
DILM32-XHIC... DILA-XHIC(V)..	DILMC7-10(230V50HZ) 277389		DILMC7-10(24VDC) 277404		1 off 	<p>Contacts to EN 50 012.</p> <p>For DILMC7 – DILMC15 the following applies:</p> <ul style="list-style-type: none"> • Auxiliary coil, and main current terminals with spring-loaded terminals. <p>For DILMC17 – DILMC150 the following applies:</p> <ul style="list-style-type: none"> • Auxiliary connections, coil connections with spring-loaded connection terminals. • Main current connections with screw terminals. <p>For DC operated contactors DILMC7 - DILMC15 the following applies:</p> <ul style="list-style-type: none"> • Integrated varistor-suppressor circuit. <p>For DC operated contactors DILMC17 - DILMC150 the following applies:</p> <ul style="list-style-type: none"> • Integrated suppressor circuit in actuating electronics <p>For AC operated contactors DILMC115 - DILMC150 the following applies:</p> <ul style="list-style-type: none"> • Integrated suppressor circuit in actuating electronics <p>For DILMC7-01 – DILMC32-01 the following applies:</p> <ul style="list-style-type: none"> • With mirror contact.
DILA-XHIC(V)..	DILMC7-01(230V50HZ) 277421		DILMC7-01(24VDC) 277436			
DILM32-XHIC... DILA-XHIC(V)..	DILMC9-10(230V50HZ) 277453		DILMC9-10(24VDC) 277468			
DILA-XHIC(V)..	DILMC9-01(230V50HZ) 277485		DILMC9-01(24VDC) 277500			
DILM32-XHIC... DILA-XHIC(V)..	DILMC12-10(230V50HZ) 277517		DILMC12-10(24VDC) 277532			
DILA-XHIC(V)..	DILMC12-01(230V50HZ) 277549		DILMC12-01(24VDC) 277564			
DILM32-XHIC... DILA-XHIC(V)..	DILMC15-10(230V50HZ) 293911		DILMC15-10(24VDC) 293926			
DILA-XHIC(V)..	DILMC15-01(230V50HZ) 293946		DILMC15-01(24VDC) 293961			
DILM32-XHIC... DILA-XHIC(V)..	DILMC17-10(230V50HZ) 277581		DILMC17-10(RDC24) 277595			
DILA-XHIC(V)..	DILMC17-01(230V50HZ) 277611		DILMC17-01(RDC24) 277625			
DILM32-XHIC... DILA-XHIC(V)..	DILMC25-10(230V50HZ) 277641		DILMC25-10(RDC24) 277655			
DILA-XHIC(V)..	DILMC25-01(230V50HZ) 277671		DILMC25-01(RDC24) 277685			
DILM32-XHIC... DILA-XHIC(V)..	DILMC32-10(230V50HZ) 277701		DILMC32-10(RDC24) 277715			
DILA-XHIC(V)..	DILMC32-01(230V50HZ) 277731		DILMC32-01(RDC24) 277745			
DILM150- XHIC(V)..	DILMC40(230V50HZ) 277965		DILMC40(RDC24) 277979			
DILM1000-XHIC..	DILMC50(230V50HZ) 277995		DILMC50(RDC24) 278009			
	DILMC65(230V50HZ) 278025		DILMC65(RDC24) 278039			
	DILMC80(230V50HZ) 239618		DILMC80(RDC24) 239652			
	DILMC95(230V50HZ) 239685		DILMC95(RDC24) 239715			
	DILMC115(RAC240) 239736		DILMC115(RDC24) 239741			
	DILMC150(RAC240) 239751		DILMC150(RDC24) 239765			

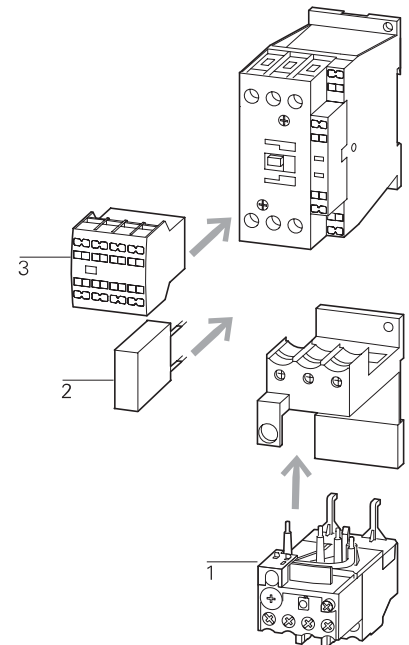

Accessories

- 1 Overload relay
- 2 Suppressor
- 3 Auxiliary contact module
- Further actuating voltages
- Accessories

Page

- Chapter 2
- 50
- 36
- 73
- 52

1.4

Contactors

Complete device up to 170 A

1

DILM complete device

Rated operational current AC-3	Max. motor rating for three-phase motors 50 - 60 Hz						Conventional free air thermal current $I_{th} = I_e$ AC-1 at 60 °C	Contact configuration: ⊕ = Safety function by positive opening according to IEC/EN 60947-5-1	Circuit symbol
	AC-3		AC-4		AC-4				
380 V 400 V	220 V 230 V	380 V 400 V	660 V 690 V	220 V 230 V	380 V 400 V	660 V 690 V	Open $I_{th} = I_e$	N/O = normally open contact NC = normally closed contact	
I_e	P	P	P	P	P	P	A		
A	kW	kW	kW	kW	kW	kW	A		

Screw terminals

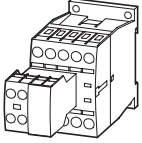

Screw terminals

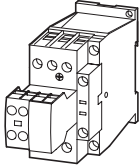

7	2.2	3	3.5	1	2.2	2.9	20	2 N/O	1 NC	
7	2.2	3	3.5	1	2.2	2.9	20	2 N/O	1 NC	
7	2.2	3	3.5	1	2.2	2.9	20	3 N/O	2 NC	
9	2.5	4	4.5	1.5	2.5	3.6	20	2 N/O	1 NC	
9	2.5	4	4.5	1.5	2.5	3.6	20	2 N/O	1 NC	
9	2.5	4	4.5	1.5	2.5	3.6	20	3 N/O	2 NC	
12	3.5	5.5	6.5	2	3	4.4	20	2 N/O	1 NC	
12	3.5	5.5	6.5	2	3	4.4	20	2 N/O	1 NC	
12	3.5	5.5	6.5	2	3	4.4	20	3 N/O	2 NC	
15.5	4	7.5	7	2	3	4.4	20	2 N/O	2 NC	
18	5	7.5	11	2.5	4.5	6.5	35	2 N/O	1 NC	
18	5	7.5	11	2.5	4.5	6.5	35	2 N/O	1 NC	
18	5	7.5	11	2.5	4.5	6.5	35	3 N/O	2 NC	
25	7.5	11	14	3.5	6	8.5	40	2 N/O	1 NC	
25	7.5	11	14	3.5	6	8.5	40	2 N/O	1 NC	
25	7.5	11	14	3.5	6	8.5	40	3 N/O	2 NC	
32	10	15	17	4	7	10	40	2 N/O	1 NC	
32	10	15	17	4	7	10	40	2 N/O	1 NC	
32	10	15	17	4	7	10	40	3 N/O	2 NC	

Information relevant for export to North America



Product Standards	IEC/EN 60947-4-1; UL 508; CSA-C22.2 No.14-05; CE marking
UL File No.	E29096
UL CCN	NLDX
CSA File No.	012528
CSA Class No.	2411-03, 3211-04
NA Certification	UL Listed, CSA certified
See also	→ Page 80

AC operation

Part no.
Article no.

Price
See price list

DC operation

Part no.
Article no.

Price
See price list

Std. pack **Notes**

DILM7-21(230V50HZ) 276620	DILM7-21(24VDC) 276635
DILM7-22(230V50HZ) 106360	DILM7-22(24VDC) 106367
DILM7-32(230V50HZ) 276655	DILM7-32(24VDC) 276670
DILM9-21(230V50HZ) 276760	DILM9-21(24VDC) 276775
DILM9-22(230V50HZ) 106361	DILM9-22(24VDC) 106368
DILM9-32(230V50HZ) 276795	DILM9-32(24VDC) 276810
DILM12-21(230V50HZ) 276900	DILM12-21(24VDC) 276915
DILM12-22(230V50HZ) 106362	DILM12-22(24VDC) 106369
DILM12-32(230V50HZ) 276935	DILM12-32(24VDC) 276950
DILM15-22(230V50HZ) 106363	DILM15-22(24VDC) 106370
DILM17-21(230V50HZ) 277068	DILM17-21(RDC24) 277082
DILM17-22(230V50HZ) 106364	DILM17-22(RDC24) 106371
DILM17-32(230V50HZ) 277100	DILM17-32(RDC24) 277114
DILM25-21(230V50HZ) 277196	DILM25-21(RDC24) 277210
DILM25-22(230V50HZ) 106365	DILM25-22(RDC24) 106372
DILM25-32(230V50HZ) 277228	DILM25-32(RDC24) 277242
DILM32-21(230V50HZ) 277324	DILM32-21(RDC24) 277338
DILM32-22(230V50HZ) 106366	DILM32-22(RDC24) 106373
DILM32-32(230V50HZ) 277356	DILM32-32(RDC24) 277370

1 off 

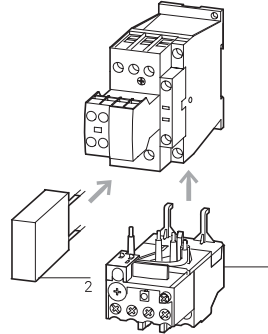

Accessories	Page
1 Overload relay	→ Chapter 2
2 Suppressor	→ 50
Accessories	→ 52

For all DC operated contactors DILM7 - DILM15 the following applies:

- Integrated varistor suppressor circuit.

For DC operated contactors DILM17 - DILM170 the following applies:

- Integrated suppressor circuit in actuating electronics

For AC operated contactors DILM115 - DILM170 the following applies:

- Integrated suppressor circuit in actuating electronics

For DILM7 - DILM150 the following applies:

- With mirror contact.

Contacts to EN 50012

1.4

Contactors

Complete device up to 170 A

1

DILM complete device

Rated operational current AC-3	Max. motor rating for three-phase motors 50 - 60 Hz						Conventional free air thermal current $I_{th} = I_b$ AC-1 at 60 °C	Contact	Circuit symbol
	AC-3		AC-4						
380 V 400 V	220 V	380 V	660 V	220 V	380 V	660 V	$I_{th} = I_b$	Contact configuration: ☉ = Safety function by positive opening according to IEC/EN 60947-5-1	
	230 V	400 V	690 V	230 V	400 V	690 V			
I_b	P	P	P	P	P	P	Open	N/O = normally open contact NC = normally closed contact	
A	kW	kW	kW	kW	kW	kW	A		

Screw terminals

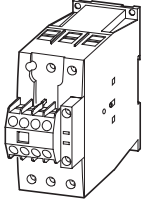

Screw terminals

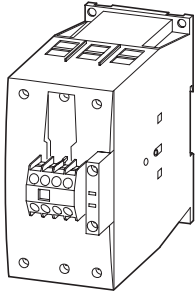

40	12.5	18.5	23	5	9	12	50	2 N/O	2 NC	
50	15.5	22	30	6	10	14	65	2 N/O	2 NC	
65	20	30	35	7	12	17	80	2 N/O	2 NC	
80	25	37	63	12	20	26	90	2 N/O	2 NC	
95	30	45	75	16	26	35	110	2 N/O	2 NC	
115	37	55	90	17	28	43	130	2 N/O	2 NC	
150	48	75	96	20	34	48	160	2 N/O	2 NC	

Information relevant for export to North America



Product Standards	IEC/EN 60947-4-1; UL 508; CSA-C22.2 No.14-05; CE marking
UL File No.	E29096
UL CCN	NLDX
CSA File No.	012528
CSA Class No.	2411-03, 3211-04
NA Certification	UL Listed, CSA certified
See also	→ Page 80

AC operation

Part no.
Article no.

Price
See price list

DC operation

Part no.
Article no.

Price
See price list

Std. pack **Notes**

DILM40-22(230V50HZ) 277798	DILM40-22(RDC24) 277812	1 off 
DILM50-22(230V50HZ) 277862	DILM50-22(RDC24) 277876	
DILM65-22(230V50HZ) 277926	DILM65-22(RDC24) 277940	
DILM80-22(230V50HZ) 239449	DILM80-22(RDC24) 239463	
DILM95-22(230V50HZ) 239527	DILM95-22(RDC24) 239541	
DILM115-22(RAC240) 239578	DILM115-22(RDC24) 239581	
DILM150-22(RAC240) 239598	DILM150-22(RDC24) 239601	

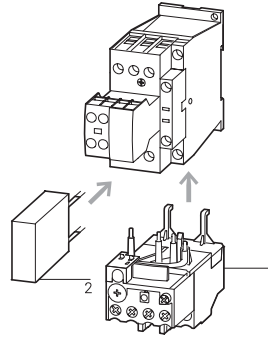

Accessories	Page
1 Overload relay	→ Chapter 2
2 Suppressor	→ 50
Accessories	→ 52

For DC operated contactors DILM17 - DILM170 the following applies:

- Integrated suppressor circuit in actuating electronics

For AC operated contactors DILM115 - DILM170 the following applies:

- Integrated suppressor circuit in actuating electronics

For DILM7 - DILM150 the following applies:

- With mirror contact.

Contacts to EN 50012

1.4

Contactors DILM, DILH

Standard devices greater than 150 A

1

DILM...S/22... Standard device for currents greater than 150 A

Rated operational current	Max. motor rating for three-phase motors 50 - 60 Hz						Conventional thermal current $I_{th} = I_e$ AC-1 at 40 °C Open $I_{th} = I_e$	Circuit symbol	For use with
	AC-3		AC-3		AC-4				
380 V	220 V	380 V	660 V	220 V	380 V	660 V	A		DILM820-XHI...
400 V	230 V	400 V	690 V	230 V	400 V	690 V			
I_e	P	P	P	P	P	P			
A	kW	kW	kW	kW	kW	kW			

DILM complete device

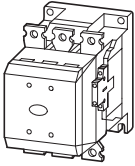

250	75	132	240	62	110	189	400		DILM820-XHI...
300	90	160	195	75	132	160	430		DILM820-XHI...
400	125	200	344	92	160	283	612		DILM820-XHI...
500	155	250	344	112	200	344	857		DILM820-XHI...
580	185	315	344	112	200	344	920		DILM820-XHI...

DILM complete device

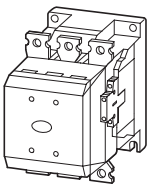

Notes

¹⁾ Availability from August 2010.
Previous DILM300/22, see Online Catalog at <http://e.cat.moeller.net>

For all contactors the following applies:

- 660 V, 690 V or 1000 V: do not reverse directly
- Integrated suppressor circuit in actuating electronics.

DILM...-S contactors are actuated conventionally

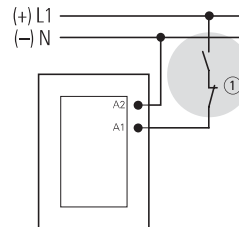

① Stopping in the event of an emergency (emergency switching off)

Accessories

Auxiliary contact modules	→ 38
Enclosures totally insulated	
Further actuating voltages	→ 77

Page

Part no.
Article no.

Price
See price list

Std. pack

Information relevant for export to North America



DILM250-S/22(220-240V50/60HZ) 274190	1 off 	Product Standards UL File No. UL CCN CSA File No. CSA Class No. NA Certification	IEC/EN 60947-4-1; UL 508; CSA-C22.2 No.14-05; CE marking E29096 NLDX 1017510 3211-04 UL Listed, CSA certified
DILM300A-S/22(220-240V50/60HZ)¹⁾ 139559	1 off 	Request filed for UL and CSA	
DILM400-S/22(220-240V50/60HZ) 274196	1 off 	Product Standards UL File No. UL CCN CSA File No. CSA Class No. NA Certification	IEC/EN 60947-4-1; UL 508; CSA-C22.2 No.14-05; CE marking E29096 NLDX 012528 3211-04 UL Listed, CSA certified
DILM500-S/22(220-240V50/60HZ) 274199	1 off 	See also	Additional approvals, → Page 82
DILM570-S/22(220-240V50/60HZ) 110744	1 off 		

1.4 Contactors DILM, DILH

Comfort devices greater than 150 A

1

DILM, DILH

Rated operational current	Max. motor rating for three-phase motors 50 - 60 Hz									Conventional thermal current $I_{th} = I_e$ AC-1 at 60 °C Open $I_{th} = I_e$	Circuit symbol
	AC-3			AC-3			AC-4				
380 V 400 V	220 V 230 V	380 V 400 V	660 V 690 V	1000 V	220 V 230 V	380 V 400 V	660 V 690 V	1000 V			
I_e	P	P	P	P	P	P	P	P	A		
A	kW	kW	kW	kW	kW	kW	kW	kW			

Contactors, comfort DILM

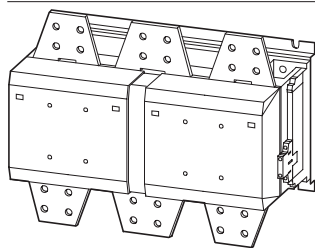
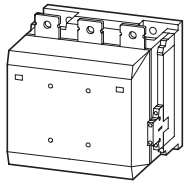
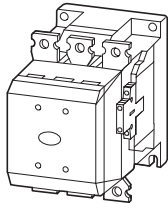
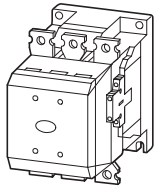
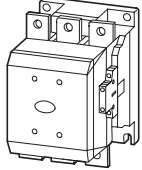

185	55	90	140	108	41	75	102	77	275	
225	70	110	150	108	51	90	110	77	315	
250	75	132	195	108	62	110	160	109	330	
300	90	160	195	132	75	132	160	109	350	
400	125	200	344	132	92	160	283	132	500	
500	155	250	344	132	112	200	344	132	700	
580	185	315	560	600	143	250	440	509	800	
650	205	355	630	600	161	280	494	509	850	
750	240	400	720	800	181	315	556	678	900	
820	260	450	750	800	209	355	633	678	1000	
1000	315	560	1000	1100	260	450	780	1000	1000	
1600	500	900	1600	1770	430	750	1300	1650	1800	

Notes

¹⁾ Availability from August 2010.
Previous DILM185/22 to DILM300/22, see Online Catalog at <http://ecat.moeller.net>

For all contactors the following applies:

- 660 V, 690 V or 1000 V: do not reverse directly
- Integrated suppressor circuit in actuating electronics.

When operating contactors DILM580 to DILM1600 behind a frequency inverter or mains with strong harmonic loads, the suppressor circuit on the load side must be removed.

During high-voltage tests, the suppressor circuit on the load-side for DILM580 to DILM1600 contactors must be disconnected (see instructional leaflet).

Control voltages

RA250 $\hat{=}$ 110 V - 250 V AC/DC

RAW250 $\hat{=}$ 230 V - 250 V AC/DC

Accessories

Auxiliary contact modules

Page

→ 38

Suppressor circuits on load side

→ 61

Enclosures

totally insulated

Further actuating voltages

→ 72

Part no. **Price** **Std. pack** **Notes**
See price list

DILM185A/22(RAC240)¹⁾
139537



Conventional

A1/A2 are attached to power supply as normal

DILM 185 A, DILM 225 A

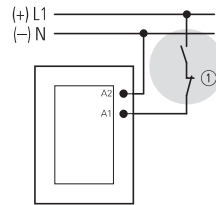

DILM250 to DILM1000, DILH1400

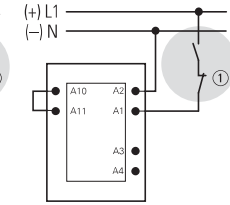

DILM1600 to DILH 2600

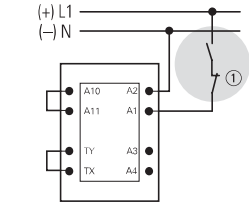

DILM250/22(RA250)²⁾
208201

DILM300A/22(RA250)^{1) 2)}
139556

Directly from the PLC

A 24 V output from the PLC can be directly connected to the terminals A4/A24.

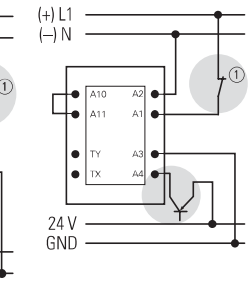
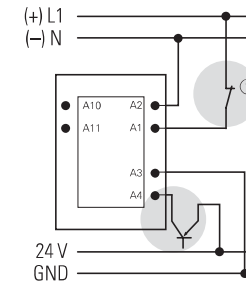
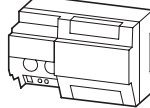

DILM400/22(RA250)³⁾
208209

DILM500/22(RA250)³⁾
208213

From a low-power command device

Low-power actuating devices such as PCB relays, pilot devices or position switches can be directly connected to A10/A11.

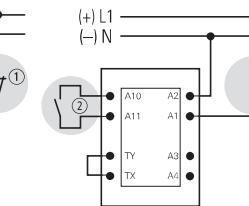
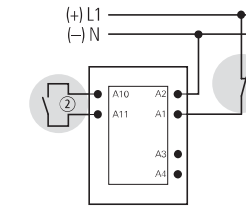

DILM580/22(RA250)³⁾
208216

DILM650/22(RA250)³⁾
208219

DILM750/22(RA250)³⁾
208222

DILM820/22(RA250)³⁾
208225

DILM1000/22(RA250)³⁾
267214

DILM1600/22(RAW250)³⁾
106727

- ① Stopping in the event of an emergency (emergency switching off)
- ② Max. cable capacitance 6 nF

Information relevant for export to North America



¹⁾ NA Certification Request filed for UL and CSA

²⁾ Product Standards IEC/EN 60947-4-1; UL 508; CSA-C22.2 No.14-05; CE marking
UL File No. E29096
UL CCN NLDX
CSA File No. 1017510
CSA Class No. 3211-04
NA Certification UL Listed, CSA certified

³⁾ Product Standards IEC/EN 60947-4-1; UL 508; CSA-C22.2 No.14-05; CE marking
UL File No. E29096
UL CCN NLDX
CSA File No. 012528
CSA Class No. 3211-04
NA Certification UL Listed, CSA certified
See also Additional approvals, → Page 82

1.4

Contactors DILM, DILH Comfort devices greater than 150 A

1

DILH comfort devices AC-1

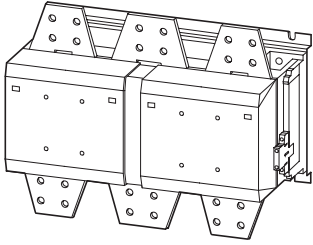

DILM, DILH

Conventional thermal current $I_{th} = I_e$
AC-1 at 60 °C
Open
 $I_{th} = I_e$
A

Circuit symbol

Part no.

Price
See price
list

Std. pack

1400		DILH1400/22(RAW250)¹⁾ 272441	1 off
2000		DILH2000/22(RAW250)¹⁾ 272442	1 off
2200		DILH2200/22(RAW250)¹⁾ 111793	1 off
2600		DILH2600/22(RAW250)²⁾ 125945	1 off

Notes

For all contactors the following applies:

- 660 V, 690 V or 1000 V: do not reverse directly
- Integrated suppressor circuit in actuating electronics.

When operating contactors DILM580 to DILM1600 behind a frequency inverter or mains with strong harmonic loads, the suppressor circuit on the load side must be removed.

During high-voltage tests, the suppressor circuit on the load-side for DILM580 to DILH2600 contactors must be disconnected (see instructional leaflet).

Control voltages

RAW250 Δ 230 V - 250 V AC/DC

Accessories

Auxiliary contact modules

Page

→ 38

Suppressor circuits on load side

→ 61

Enclosures

Notes

Conventional

A1/A2 are attached to power supply as normal

DILH1400

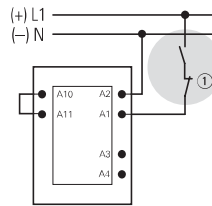

DILM1600 to DILH 2600

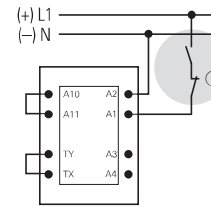

Directly from the PLC

A 24 V output from the PLC can be directly connected to the terminals A4/A24.

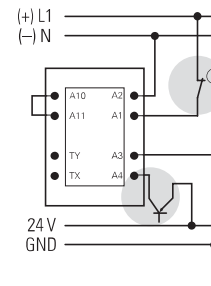
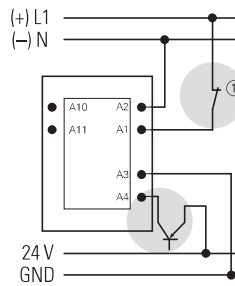
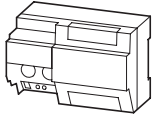

From a low-power command device

Low-power actuating devices such as PCB relays, pilot devices or position switches can be directly connected to A10/A11.

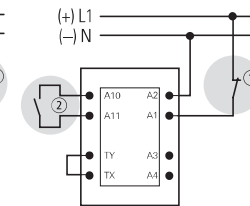
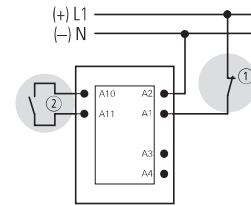

- ① Stopping in case of emergency (Emergency-stop)
- ② Max. cable capacitance 6 nF

Information relevant for export to North America



1)	
Product Standards	IEC/EN 60947-4-1; UL 508; CSA-C22.2 No.14-05; CE marking
UL File No.	E29096
UL CCN	NLDX
CSA File No.	012528
CSA Class No.	3211-04
NA Certification	UL Listed, CSA certified

2)	
NA Certification	Request filed for UL and CSA

1.4

Leistungsschütze

Basic devices up to 200 A

1

DILMP 4 pole

Rated operational current open

Conventional thermal current

Circuit symbol

For use with

AC-1

$I_{th} = I_e$ AC-1 at 50 °C

Open

40 °C 55 °C 70 °C

$I_{th} = I_e$

A A A

A

22 21 20



DILM32-XHI(C)...
DILA-XHI(V)(C)...

Contactors up to 200 A
4 pole

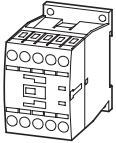

Notes

¹⁾ DILM1000-XHI... can only be fitted on the left of DILMP.

Contacts to EN 50012.

For DC operated contactors DILMP20 the following applies:

- Integrated varistor suppressor circuit.

For DC operated contactors DILMP32 - DILMP200 the following applies:

- Integrated suppressor circuit in actuating electronics.

For AC operated contactors DILMP125 - DILMP200 the following applies:

- Integrated suppressor circuit in actuating electronics.

For DILMP32-01 and DILMP45-01 the following applies:

- With mirror contact.

AC operation

Part no.
Article no.

Price
See
price
list

Std. pack

DC operation

Part no.
Article no.

Price
See
price list

Std. pack

Notes

DILMP20(230V50HZ,240V60HZ)
276970

1 off

DILMP20(24VDC)
276985

1 off

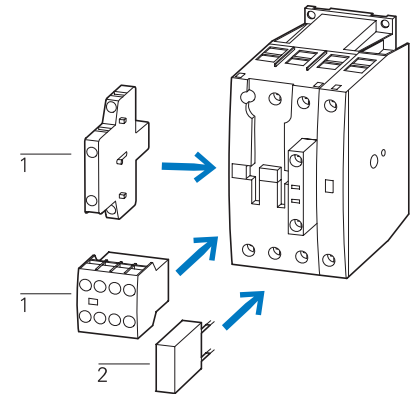
Accessories

- 1 Auxiliary contact module
- 2 Suppressor
- Further actuating voltages
- Accessories

Page

- 36
- 50
- 74
- 52

Information relevant for export to North America



Product Standards	IEC/EN 60947-4-1; UL 508; CSA-C22.2 No.14-05; CE marking
UL File No.	E29096
UL CCN	NLDX
CSA File No.	012528
CSA Class No.	2411-03, 3211-04
NA Certification	UL Listed, CSA certified
See also	→ Page 81

1.4















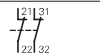





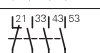





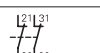



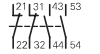



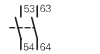

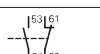



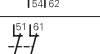

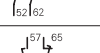



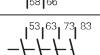



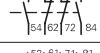

Contactors

Auxiliary contact modules

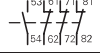
1

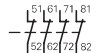
DILM, DILA Auxiliary contact modules

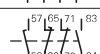

With interlocked opposing contacts, except ...XHI(C)V

Terminal type	Pole	Conventional thermal current $I_{th} = I_e$ AC-1 at 60 °C Open $I_{th} = I_e$ A	Contact configuration	Circuit symbol	For use with	Part no.	Price See price list	Std. pack
 Screw terminals	2 pole	16	1 N/O 1 NC		DILM(C)7-10...	DILM32-XHI11 277376		5 off  
	2 pole	16	— 1 NC		DILM(C)9-10... DILM(C)12-10... DILM(C)15-10... DILM(C)17-10... DILM(C)25-10... DILM(C)32-10... DILM38-...10... DILMP20... DILMP32-10... DILMP45-10... DILL...	DILM32-XHI02 277375		5 off  
 Screw terminals	4 pole	16	2 N/O 2 NC			DILM32-XHI22 277377		5 off  
	4 pole	16	3 N/O 1 NC			DILM32-XHI31 106112		5 off  
 Spring-loaded terminals	2 pole	16	1 N/O 1 NC			DILM32-XHIC11 277751		5 off  
	2 pole	16	— 2 NC			DILM32-XHIC02 277750		5 off  
 Spring-loaded terminals	4 pole	16	2 N/O 2 NC			DILM32-XHIC22 277752		5 off  
 Screw terminals	2 pole	16	1 N/O —		DILM(C)9...	DILA-XHI20 276422		5 off  
	2 pole	16	1 N/O 1 NC		DILM(C)9... DILM(C)12... DILM(C)15... DILM(C)17... DILM(C)25... DILM(C)32... DILM38... DILMP20... DILMP32... DILMP45... DILL...	DILA-XHI11 276421		5 off  
 Screw terminals	2 pole	16	— 2 NC			DILA-XHI02 276420		5 off  
	2 pole	16	1 S _F 1 Ö _S			DILA-XHIV11 276423		5 off  
 Screw terminals	4 pole	16	4 N/O —			DILA-XHI40 276428		5 off  
	4 pole	16	3 N/O 1 NC			DILA-XHI31 276427		5 off  
	4 pole	16	2 N/O 2 NC			DILA-XHI22 276426		5 off  
	4 pole	16	1 N/O 3 NC			DILA-XHI13 276425		5 off  
	4 pole	16	— 4 NC			DILA-XHI04 276424		5 off  
	4 pole	16	1 N/O 1 NC			DILA-XHIV22 276429		5 off  
	4 pole	16	1 S _F 1 Ö _S					5 off  

Notes

- Auxiliary NC usable as mirror contact according to IEC/EN 60947-4-1, Annex F
- Interlocked opposing contacts according to IEC/EN 60947-5-1 Annex L, inside the auxiliary contact modules, also for the integrated auxiliary contacts of the DILM 7 - DILM32

Information relevant for export to North America

 	Product Standards	IEC/EN 60947-4-1; UL 508; CSA-C22.2 No.14-05; CE marking
	UL File No.	E29184
	UL CCN	NKCR
	CSA File No.	012528
	CSA Class No.	3211-03
	NA Certification	UL Listed, CSA certified

DILM, DILA
Auxiliary contact modules

With interlocked opposing contacts, except ...XHI(C)V

Top mounting auxiliary contacts



Top mounting auxiliary contacts



Top mounting auxiliary contacts



Terminal type	Pole	Conventional thermal current $I_{th} = I_e$ AC-1 at 60 °C Open $I_{th} = I_e$ A	Contact configuration	Circuit symbol	For use with	Part no.	Price See price list	Std. pack
Spring-loaded terminals	2 pole	16	2 N/O	—		DILM(C)7... DILM(C)9... DILM(C)12... DILM(C)15... DILM(C)17... DILM(C)25... DILM(C)32... DILM38... DILMP20... DILMP32... DILMP45... DILL...	DILA-XHIC20 276528	5 off
	2 pole	16	1 N/O 1 NC			DILA-XHIC11 276527	5 off 	
	2 pole	16	— 2 NC			DILA-XHIC02 276526	5 off 	
	2 pole	16	1 S _F 1 Ö _S			DILA-XHICV11 276529	5 off 	
Screw terminals	2 pole	16	2 N/O 2 NC			DILA-XHIR22¹⁾ 139580	5 off 	
	2 pole	16	1 N/O 1 NC			DILA-XHIR11 110140	5 off 	
Spring-loaded terminals	4 pole	16	4 N/O	—		DILM(C)9... DILM(C)9... DILM(C)12... DILM(C)15... DILM(C)17... DILM(C)25... DILM(C)32...	DILA-XHIC40 276534	5 off
	4 pole	16	3 N/O 1 NC			DILA-XHIC31 276533	5 off 	
	4 pole	16	2 N/O 2 NC			DILA-XHIC22 276532	5 off 	
	4 pole	16	1 N/O 3 NC			DILA-XHIC13 276531	5 off 	
	4 pole	16	— 4 NC			DILA-XHIC04 276530	5 off 	
	4 pole	16	1 N/O 1 S _F 1 Ö _S			DILA-XHICV22 276535	5 off 	

Notes

- Auxiliary NC usable as mirror contact according to IEC/EN 60947-4-1, Annex F
 - Interlocked opposing contacts according to IEC/EN 60947-5-1 Annex L, inside the auxiliary contact modules, also for the integrated auxiliary contacts of the DILM 7 - DILM32
- ¹⁾ 1 N/C + 1 N/O above microswitch for electronic applications

Information relevant for export to North America

	Product Standards	IEC/EN 60947-4-1; UL 508; CSA-C22.2 No.14-05; CE marking
	UL File No.	E29184
	UL CCN	NKCR
	CSA File No.	012528
	CSA Class No.	3211-03
	NA Certification	UL Listed, CSA certified

¹⁾ NA Certification Request filed for UL and CSA

















































1.4

Contactors Auxiliary contact modules

1

DILM Auxiliary contact modules

With interlocked opposing contacts

Connection type	Pole	conventional thermal current $I_{th} = I_e$ AC-1 at 60 °C Open $I_{th} = I_e$ A	Contact configuration N/O = normally open contact SF = N/O early make NC = normally closed contact ÖS = NC late-break	Circuit symbol	For use with	Part no. Article no.	Price See price list	Std. pack	Notes
	Screw terminals	2 pole	16	2 N/O –		DILM40... DILM50... DILM65... DILM72... DILM80... DILM95... DILM115... DILM150... DILM170... DILMP63... DILMP80...	DILM150-XHI20 277945	5 off  	Interlocked opposing contacts according to IEC/EN 60947-5-1 Annex L, inside the auxiliary contact modules
		2 pole	16	1 N/O 1 NC		DILM72... DILM80... DILM95... DILM115... DILM150... DILM170... DILMP63... DILMP80... DILMP125... DILMP160... DILMP200...	DILM150-XHI11 277946	5 off  	Annex L, inside the auxiliary contact modules
		2 pole	16	1 N/O 1 NC			DILM150-XHIA11 283463	5 off  	Auxiliary NC usable as mirror contact according to IEC/EN 60947-4-1, Annex F
		2 pole	16	– 2 NC			DILM150-XHI02 277947	5 off  	
	Screw terminals	4 pole	16	4 N/O –			DILM150-XHI40 277948	5 off  	
		4 pole	16	3 N/O 1 NC			DILM150-XHI31 277949	5 off  	
		4 pole	16	2 N/O 2 NC			DILM150-XHI22 277950	5 off  	
		4 pole	16	2 N/O 2 NC			DILM150-XHIA22 283464	5 off  	
		4 pole	16	1 N/O 3 NC			DILM150-XHI13 277951	5 off  	
		4 pole	16	– 4 NC			DILM150-XHI04 277952	5 off  	
		4 pole	16	1 N/O 1 NC 1 SF 1 ÖS			DILM150-XHIV22 277953	5 off  	–
		Screw terminals	2 pole	16	2 N/O –		DILM7... DILM9... DILM12... DILM15... DILL...	DILA-XHIT20 101042	5 off  
		2 pole	16	1 N/O 1 NC			DILA-XHIT11 101043	5 off  	Auxiliary NC usable as mirror contact according to IEC/EN 60947-4-1, Annex F
		2 pole	16	– 2 NC			DILA-XHIT02 101041	5 off  	
		Screw terminals	4 pole	16	2 N/O 2 NC		DILA-XHIT22 101044	5 off  	

Notes 1) Suitable for the combination with electrical wiringlinks

in tool-less plug connection usable with:

- DILM12-XSL
- DILM12-XRL
- DILM12-XS1
- PKZM0-XDM12
- PKZM0-XRM12
- PKZM0-XSM12

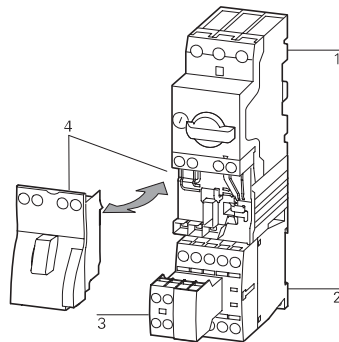

- 1 PKZM0
- 2 DILM7 - DILM15
- 3 DILA-XHIT
- 4 PKZM0-XDM12

Information relevant for export to North America



Product Standards

UL File No.
UL CCN
CSA File No.
CSA Class No.
NA Certification

IEC/EN 60947-4-1; UL 508;
CSA-C22.2 No.14-05; CE marking
E29184
NKCR
012528
3211-03
UL Listed, CSA certified

DILM, DILA

Connection type	Pole	conventional thermal current $I_{th} = I_e$ AC-1 at 60 °C Open $I_{th} = I_e$ A	Contact configuration N/O = normally open contact SF = N/O early make NC = normally closed contact ÖS = NC late-break	Circuit symbol	For use with	Part no. Article no.	Price See price list	Std. pack	Notes
-----------------	------	--	---	----------------	--------------	----------------------	----------------------	-----------	-------

Side-mounting auxiliary contacts

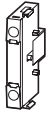

Screw terminals	1 pole	10	1 N/O –		DILM(C)7... DILM(C)9... DILM(C)12... DILM(C)15... DILMP20... DILA(C)...	DILA-XH10-S 115948	1 off		1)
	1 pole	10	– 1 NC			DILA-XH01-S 115949	1 off		
Spring-loaded terminals	1 pole	10	1 N/O –			DILA-XHIC10-S 115950	1 off		
	1 pole	10	– 1 NC			DILA-XHIC01-S 115951	1 off		

Side-mounting auxiliary contacts

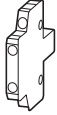

Screw terminals	2 pole	10	1 N/O 1 NC		DILM17... DILM25... DILM32... DILM38...	DILM32-XH11-S 101371	1 off		Can only be left on the contactor. Cannot be combined with mechanical interlock
-----------------	--------	----	------------	--	--	--------------------------------	-------	--	---

Side-mounting auxiliary contacts

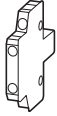

Screw terminals	2 pole	10	1 N/O 1 NC		DILM250 - DILH2600	DILM820-XH11-SI 208281	1 off		1)
	2 pole	10	1 N/O 1 NC			DILM820-XH11-SA 208282	1 off		
	2 pole	10	1 S _F 1 Ö _S			DILM820-XH11V-SI 208283	1 off		
Screw terminals	2 pole	10	1 N/O 1 NC		DILM40 - DILM225A DILMP63 - DILMP200	DILM1000-XH11-SI 278425	1 off		
	2 pole	10	1 S _F 1 Ö _S			DILM1000-XH11V-SI 278426	1 off		
	2 pole	10	1 N/O 1 NC			DILM1000-XH11-SA 278427	1 off		

Notes

- 1)
- Interlocked opposing contacts according to IEC/EN 60947-5-1 Annex L, inside the auxiliary contact module, also for the integrated auxiliary contacts of the DILM7 – DILM32 (not NO early-make and NC late-break)
 - Auxiliary NC usable as mirror contact according to IEC/EN 60947-4-1, Annex F (no NC late-breaks)
 - No auxiliary contact is possible between 2 contactors with mechanical interlock.

Information relevant for export to North America



2)

Product Standards	IEC/EN 60947-4-1; UL 508; CSA-C22.2 No.14-05; CE marking
UL File No.	E29184
UL CCN	NKCR
CSA File No.	012528
CSA Class No.	3211-03,3211-04
NA Certification	UL Listed, CSA certified

1.5

Contactors

Auxiliary contact modules

1 Engineering

DILM, DILH

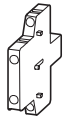

DILM1000-
XHI(V)11-SI

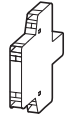

DILM820-
XHI(V)11-SI

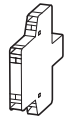

DILM1000-
XHI(V)11-SA



DILM820-
XHI(V)11-SA



DILM150-XHI20
DILM150-XHI11
DILM150-XHI02



DILM150-XHI40
DILM150-XHI31
DILM150-
XHI(V)22
DILM150-XHI13
DILM150-XHI04



DILM150-
XHIA11



DILM150-
XHIA22

DILM40	2 x	–	–	–	–	–	1 x	–
... DILM72	–	–	2 x	–	1 x	–	–	–
	1 x	–	–	–	–	–	–	1 x
	–	–	1 x	–	–	1 x	–	–
DILM80	2 x	–	2 x	–	–	–	–	–
... DILM170	2 x	–	–	–	–	–	–	1 x
	–	–	2 x	–	–	1 x	–	–
	–	–	2 x	–	1 x	–	–	–
DILM185A	2 x	–	2 x	–	–	–	–	–
DILM222A	2 x	–	–	–	–	–	–	–
DILM250 DILM1600	–	2 x	–	2 x	–	–	–	–
DILH1400	–	2 x	–	2 x	–	–	–	–
... DILH2600	–	–	–	–	–	–	–	–

Notes

Side mounting auxiliary contacts

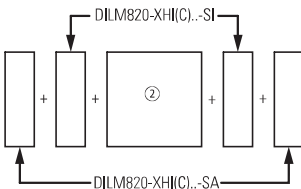
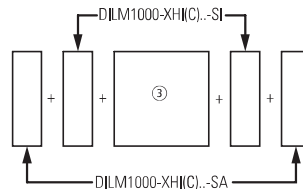
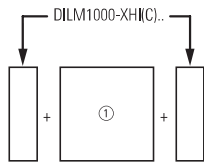

- ① DILM40 – DILM72
- ② DILM250 – DILH2600
- ③ DILM80-DILM225A

- Interlocked opposing contacts according to IEC/EN 60947-5-1 Annex L, inside the auxiliary contact module (not N/O early close and N/C late open)
- Auxiliary contacts can be used as mirror contacts according to IEC/EN 60947-4-1, Annex F (not N/C late open)
- No auxiliary contact is possible between two contactors with mechanical interlock.
- 2 auxiliary contacts DILM820-XHI11-SI are already built into the contactors DILM250 to DILH2600/22.
- 2 DILM1000-XHI11-SI auxiliary contacts are already installed in DILM185A and DILH225A contactors.

Ordering

DILK

Three-phase capacitors
50 – 60 Hz
Open

230 V	400 V	525 V	690 V
-------	-------	-------	-------

Circuit symbol

Part no.
Article no.

Price
See price list

Std. pack

kvar	kvar	kvar	kvar
7.5	12.5	16.7	20
11	20	25	33.3
15	25	33.3	40
20	33.3	40	55
25	50	65	85

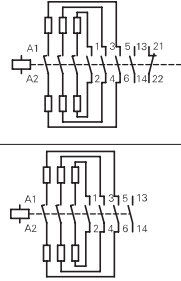

DILK12-11(230V50HZ,240V60HZ) 293988	1 off	
DILK20-11(230V50HZ,240V60HZ) 294010	1 off	
DILK25-11(230V50HZ,240V60HZ) 294032	1 off	
DILK33-10(230V50HZ,240V60HZ) 294054	1 off	
DILK50-10(230V50HZ,240V60HZ) 294076	1 off	

With series resistors
Basic Units

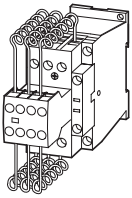

Notes

Weld-resistant for capacitors with inrush current peaks up to $180 \times I_N$
With group compensation multi-stage capacitor banks are connected to the mains as required. This can cause, transient currents of up to $180 \times I_e$ to flow between the capacitors.
The capacitors are pre-charged via the early-make auxiliary contacts and the fitted wire resistors, thereby reducing the inrush current. The main contacts then close after a time lag and carry the continuous current.
The contactors for capacitors are weld-resistant with inrush current peaks up to $180 \times I_e$ due to their special contacts.
DILK... cannot be combined with other auxiliary contacts.
For the switching of reactive-power compensation equipment please see Engineering notes on power factor correction → page 33.

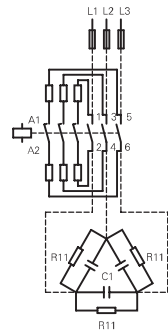

Accessories	Page
Enclosures	
Accessories	→ 52
Further actuating voltages	→ 76

Information relevant for export to North America



Product Standards	IEC/EN 60947-4-1; UL 508; CSA-C22.2 No.14-05; CE marking
UL File No.	E29096
UL CCN	NLDX
CSA File No.	012528
CSA Class No.	3211-04
NA Certification	UL Listed, CSA certified
See also	Further approvals → Page 66

1.7

Contactors

Contactors for power factor correction

1 Engineering

DILM, DILK

Part no.	Ordering data	Switching power			
		230 V	400 V 420 V 440 V	525 V	690 V
	Page	kvar	kvar	kvar	kvar
Individual compensation, open version					
DILM7-...(…)	→ 18	1,5	3	3,5	5
DILM9-...(…)	→ 18	2	4	4,5	6
DILM12-...(…)	→ 18	2,5	4,5	5,5	7
DILM15-...(…)	→ 18	2,5	4,5	5,5	7
DILM17-...(…)	→ 18	6,5	12	14,5	19
DILM25-...(…)	→ 18	7	13,5	16	21
DILM32-...(…)	→ 18	7,5	14,5	17	22,5
DILM40(…)	→ 20	11	20,5	24,5	32
DILM50(…)	→ 20	11,5	22	26	34,5
DILM65(…)	→ 20	12,5	23,5	28	37
DILM80(…)	→ 20	16	30,5	36,5	48
DILM95(…)	→ 20	18	34	41	54
DILM115(…)	→ 20	24	46	54,5	72
DILM150(…)	→ 20	28	53	63,5	83,5
DILM185A(…)	→ 30	87	150	190	150
DILM300A(…)	→ 30	115	200	265	200
DILM580(…)	→ 30	175	300	400	300
Group compensation, with choke, open version					
DILM7-...(…)	→ 18	4	7	7,5	12
DILM9-...(…)	→ 18	5	8	10	14
DILM12-...(…)	→ 18	5,5	10	12	16
DILM15-...(…)	→ 18	5,5	10	12	16
DILM17-...(…)	→ 18	7,5	18	20	28
DILM25-...(…)	→ 18	10	20	23	30
DILM32-...(…)	→ 18	12,5	25	25	32
DILM40(…)	→ 20	15	30	30	40
DILM50(…)	→ 20	20	40	40	48
DILM65(…)	→ 20	25	50	50	57
DILM80(…)	→ 20	30	60	70	90
DILM95(…)	→ 20	35	70	80	104
DILM115(…)	→ 20	50	95	100	125
DILM150(…)	→ 20	55	115	115	152
DILM185A(…)	→ 30	80	150	200	260
DILM225A(…)	→ 30	100	175	230	300
DILM250(…)	→ 30	110	190	260	340
DILM300A(…)	→ 30	130	225	290	390
DILM400(…)	→ 30	160	280	370	480
DILM500(…)	→ 30	220	390	500	680
Group compensation, without choke, open version					
DILK12-...(…)	→ 41	7,5	12,5	16,7	20
DILK20-...(…)	→ 41	11	20	25	33,3
DILK25-...(…)	→ 41	15	25	33,3	40
DILK33-...(…)	→ 41	20	33,3	40	55
DILK50-...(…)	→ 41	25	50	65	85
DILM185A(…)	→ 41	66	115	145	115
DILM300A(…)	→ 41	85	150	195	150
DILM580(…)	→ 41	145	250	333	250

Notes

Use of the contactors DILM without series resistor for group compensation

When using the contactors for group compensation in a system without chokes each capacitor must have a minimum induction of approx. 6 μH to limit the peak inrush current. This corresponds to an air-cored coil with 5 windings and a coil diameter of approximately ∅140 mm. The conductor cross section must correspond to the rated operational current.

1.8 Contactor combinations

Star-delta combinations

Ordering

1

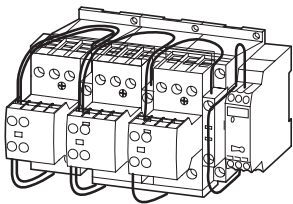
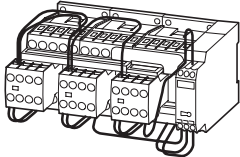
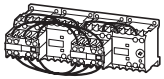

Star-delta combinations SDAINL

Operating frequency: maximum 30 starts per hour

Rated operational current AC-3	Max. rated operational power for three-phase motors, 50 - 60 Hz AC-3					Max. change-over time s	Part no. Article no.	Price See price list	Std. pack
	400 V	230 V	400 V	500 V	690 V				
I _e	P	P	P	P	P				
A	kW	kW	kW	kW	kW				
12	4	5.5	5.5	–	–	< 30	SDAINLEM(230V50HZ) 051840		1 off
12	3	5.5	5.5	5.5	–	< 20	SDAINLM12(230V50HZ) 278286		1 off
12	3	5.5	5.5	5.5	–	< 20	SDAINLM12(400V50HZ) 101380		1 off
12	3	5.5	5.5	5.5	–	< 20	SDAINLM12(24VDC) 100416		1 off
16	4	7.5	7.5	7.5	–	< 20	SDAINLM16(230V50HZ) 278311		1 off
16	4	7.5	7.5	7.5	–	< 20	SDAINLM16(400V50HZ) 101381		1 off
16	4	7.5	7.5	7.5	–	< 20	SDAINLM16(24VDC) 100417		1 off
22	5.5	11	11	11	–	< 20	SDAINLM22(230V50HZ) 278336		1 off
22	5.5	11	11	11	–	< 20	SDAINLM22(400V50HZ) 101382		1 off
22	5.5	11	11	11	–	< 20	SDAINLM22(24VDC) 100418		1 off
30	7.5	15	18.5	18.5	–	< 20	SDAINLM30(230V50HZ) 278361		1 off
30	7.5	15	18.5	18.5	–	< 20	SDAINLM30(400V50HZ) 101383		1 off
30	7.5	15	18.5	18.5	–	< 20	SDAINLM30(RDC24) 100419		1 off
45	11	22	30	22	–	< 20	SDAINLM45(230V50HZ) 278386		1 off
45	11	22	30	22	–	< 20	SDAINLM45(400V50HZ) 101384		1 off
45	11	22	30	22	–	< 20	SDAINLM45(RDC24) 100420		1 off
55	15	30	37	30	–	< 20	SDAINLM55(230V50HZ) 278411		1 off
55	15	30	37	30	–	< 20	SDAINLM55(400V50HZ) 101385		1 off
55	15	30	37	30	–	< 20	SDAINLM55(RDC24) 100421		1 off
70	18.5	37	45	37	–	< 20	SDAINLM70(230V50HZ) 239895		1 off
70	18.5	37	45	37	–	< 20	SDAINLM70(400V50HZ) 101386		1 off
90	22	45	55	45	–	< 20	SDAINLM90(230V50HZ) 239937		1 off
115	30	55	75	55	–	< 20	SDAINLM115(230V50HZ) 239963		1 off
140	37	75	90	90	–	< 20	SDAINLM140(230V50HZ) 240009		1 off
165	45	90	110	132	–	< 20	SDAINLM165(230V50HZ) 240035		1 off
200	55	110	132	160	–	< 20	SDAINLM200(230V50HZ) 101010		1 off
260	75	132	160	160	–	< 20	SDAINLM260(230V50HZ) 101031		1 off

Individual components of the combination

Spare auxiliary contacts

Notes

Mains contactor Q11	Delta contactor Q15	Star contactor Q13	Timing relays K1	Q11	Q13	Q15
Part no.	Part no.	Part no.	Part no.			
DILEM-10 + 22DILEM	DILEM-01	DILEM-10 + 02DILEM	DILET		-	-
DILM7-10 + DILA-XHI20	DILM7-01 + DILA-XHI20	DILM7-01 + DILA-XHI20	ETR4-51			
DILM7-10 + DILA-XHI20	DILM7-01 + DILA-XHI20	DILM7-01 + DILA-XHI20	ETR4-51			
DILM7-10 + DILA-XHI20	DILM7-01 + DILA-XHI20	DILM7-01 + DILA-XHI20	ETR4-51			
DILM9-10 + DILA-XHI20	DILM9-01 + DILA-XHI20	DILM7-01 + DILA-XHI20	ETR4-51			
DILM9-10 + DILA-XHI20	DILM9-01 + DILA-XHI20	DILM7-01 + DILA-XHI20	ETR4-51			
DILM9-10 + DILA-XHI20	DILM9-01 + DILA-XHI20	DILM7-01 + DILA-XHI20	ETR4-51			
DILM12-10 + DILA-XHI20	DILM12-01 + DILA-XHI20	DILM7-01 + DILA-XHI20	ETR4-51			
DILM12-10 + DILA-XHI20	DILM12-01 + DILA-XHI20	DILM7-01 + DILA-XHI20	ETR4-51			
DILM12-10 + DILA-XHI20	DILM12-01 + DILA-XHI20	DILM7-01 + DILA-XHI20	ETR4-51			
DILM17-10 + DILA-XHI20	DILM17-01 + DILA-XHI20	DILM17-01 + DILA-XHI20	ETR4-51			
DILM17-10 + DILA-XHI20	DILM17-01 + DILA-XHI20	DILM17-01 + DILA-XHI20	ETR4-51			
DILM17-10 + DILA-XHI20	DILM17-01 + DILA-XHI20	DILM17-01 + DILA-XHI20	ETR4-51			
DILM25-10 + DILA-XHI20	DILM25-01 + DILA-XHI20	DILM17-01 + DILA-XHI20	ETR4-51			
DILM25-10 + DILA-XHI20	DILM25-01 + DILA-XHI20	DILM17-01 + DILA-XHI20	ETR4-51			
DILM25-10 + DILA-XHI20	DILM25-01 + DILA-XHI20	DILM17-01 + DILA-XHI20	ETR4-51			
DILM32-10 + DILA-XHI20	DILM32-01 + DILA-XHI20	DILM25-01 + DILA-XHI20	ETR4-51			
DILM32-10 + DILA-XHI20	DILM32-01 + DILA-XHI20	DILM25-01 + DILA-XHI20	ETR4-51			
DILM32-10 + DILA-XHI20	DILM32-01 + DILA-XHI20	DILM25-01 + DILA-XHI20	ETR4-51			
DILM40 + DILM150-XHI31	DILM40 + DILM150-XHI11	DILM40 + DILM150-XHI11	ETR4-51		-	-
DILM40 + DILM150-XHI31	DILM40 + DILM150-XHI11	DILM40 + DILM150-XHI11	ETR4-51		-	-
DILM50 + DILM150-XHI31	DILM50 + DILM150-XHI11	DILM40 + DILM150-XHI11	ETR4-51		-	-
DILM65 + DILM150-XHI31	DILM65 + DILM150-XHI11	DILM40 + DILM150-XHI11	ETR4-51		-	-
DILM80 + DILM150-XHI31	DILM80 + DILM150-XHI11	DILM50 + DILM150-XHI11	ETR4-51		-	-
DILM95 + DILM150-XHI31	DILM95 + DILM150-XHI11	DILM65 + DILM150-XHI11	ETR4-51		-	-
DILM115 + DILM150-XHI31	DILM115 + DILM150-XHI11	DILM80 + DILM150-XHI11	ETR4-51		-	-
DILM150 + DILM150-XHI31	DILM150 + DILM150-XHI11	DILM95 + DILM150-XHI11	ETR4-51		-	-

Main circuit:
Depending on the type of coordination required (i.e. Type "1" or Type "2") it must be established whether the fuse protection and the input wiring for the mains contactor and delta contactor are to be common or separate.

The following applies for SDAINLM 140 – SDAINLM 260:
• On the mounting plate.

Circuit diagrams, Star-delta combinations → page 46

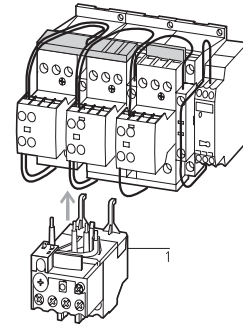

Accessories

1 Overload relay

Accessories

Page

→ 8

→ 52

1.9 Contactor combinations

Star-delta combinations

1 Engineering

SDAINL Circuit diagrams, Star-delta combinations

SDAINLEM

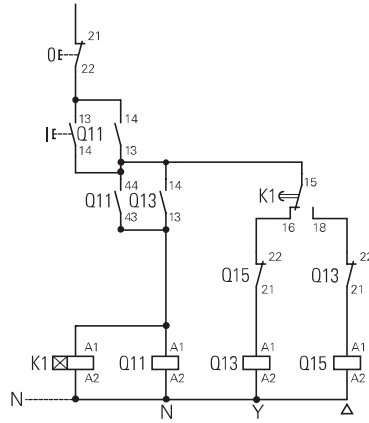
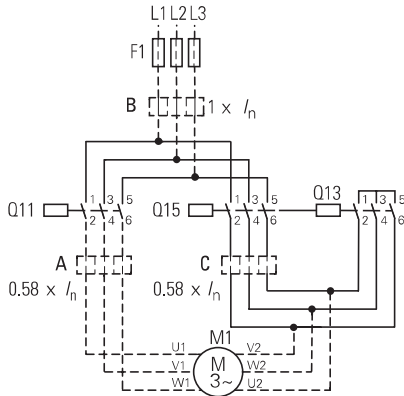

SDAINLM12...SDAINLM55

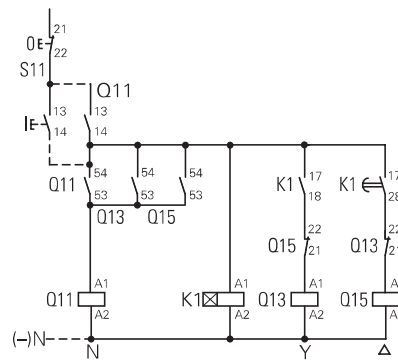
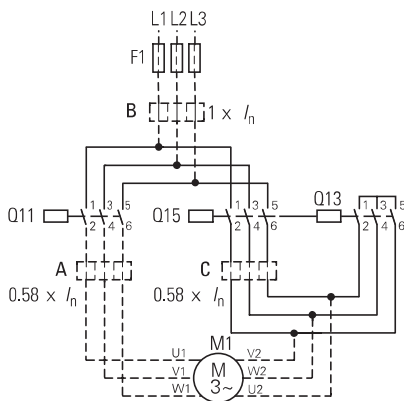

SDAINLM70...SDAINLM260

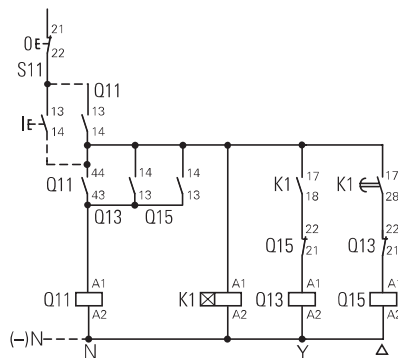
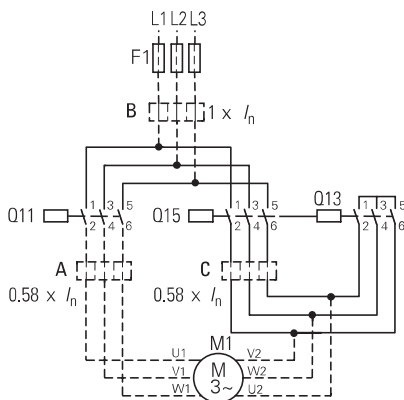

Overload relay settings

A: $I_N \times 0.58$
Motor protected in Y and Δ - positions

B: $I_N \times 1$
Only partial motor protection in Y position

C: $I_N \times 0.58$
Motor not protected in Y position

Timing relay set to approx. 10 s

Main circuit:

Depending on the type of coordination required (i.e. Type "1" or Type "2") it must be established whether the fuse protection and the input wiring for the mains contactor and delta contactor are to be common or separate.

Starting

F 15 s

15 – 40 s

> 40 s

SDAINL Components for self-assembly of star-delta combinations

Maximum operational rating of AC motors 50 - 60 Hz AC-3

Changeover time¹⁾

Individual components of the combination

Spare auxiliary contacts

230 V kW	400 V kW	500 V kW	690 V kW	1000 V kW	up to 12 s	up to 20 s	up to 30 s	Coil to EN 50005 Switching element to EN 50005 and EN 50012			Timing relay K1 Part no.	Spare auxiliary contacts		
								Mains contactor Q11 Part no. DIL	Delta contactor Q15 Part no. DIL	Star contactor Q13 Part no. DIL		Q11	Q15	Q13
90	160	200	250	132	●	●	●	M185A/22	M185A/22	M115/22	ETR4-51			
110	200	250	315	160	●	●	—	M225A/22	M225A/22	M150/22	ETR4-51			
132	250	315	400	200	●	●	●	M250/22	M250/22	M185A/22	ETR4-51			
160	300	355	450	200	●	●	●	M300A/22	M300A/22	M185A/22	ETR4-51			
200	355	450	560	220	●	●	—	M400/22	M400/22	M250/22	ETR4-51			
250	450	560	600	220	●	●	●	M500/22	M500/22	M300A/22	ETR4-51			
300	560	710	900	355	●	●	●	M580/22	M580/22	M400/22	ETR4-51			
350	630	750	950	355	●	●	●	M650/22	M650/22	M400/22	ETR4-51			
400	710	900	1200	1400	●	●	●	M750/22	M750/22	M580/22	ETR4-51			
450	800	950	1300	1400	●	●	●	M820/22	M820/22	M580/22	ETR4-51			
560	1000	1200	1700	1700	●	●	—	M1000/22	M1000/22	M650/22	ETR4-51			

Notes

¹⁾ Longer changeover times please enquire

Components for self-assembly

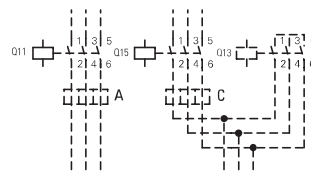
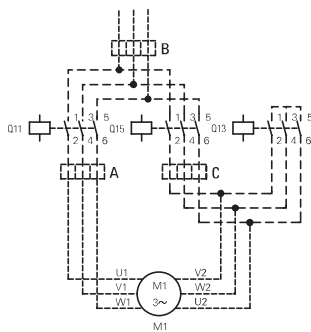

Notes

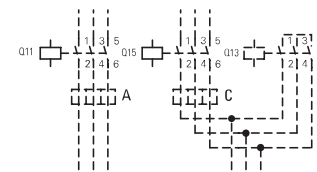

Overload relay settings

Timing relay set to approx. 10 s

I_N	Starting	Main circuit: Depending on the coordination type required (i.e. Type "1" or Type "2") it must be established whether the fuse protection and the input wiring for the mains contactor and delta contactor are to be common or separate.
A x 0.58 Motor protection in Y and Δ positions	≤ 15 s	
B x 1 In Y position only limited motor protection	15 – 40 s	Control circuit: If the combinations are to be used within the scope of IEC/EN 60 204 Part 1, VD E 0113 Part 1, then Point 9.1.1 regarding the supply of control circuits, must be observed.
C x 0.58 Motor not protected in Y position	> 40 s	

1.10

Contactors combinations

Reversing combinations

1 Ordering

DIUL reversing combinations

Rated operational current
AC-3

Max. motor rating for three-phase motors 50 - 60 Hz
AC-3

Part no.

Price
See price list

Std. pack

400 V	AC-3			AC-4		
	220 V 230 V	380 V 400 V	660 V 690 V	220 V 230 V	380 V 400 V	660 V 690 V
I_e	P	P	P	P	P	P
A	kW	kW	kW	kW	kW	kW

AC operation

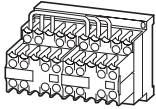

9	2.2	4	4	1.5	3	3	DIULEM/21/MV(230V50HZ)¹⁾ 051849	1 Off	
9	2.2	4	4	1.5	3	3	DIULEM/21/MV-G(24VDC)²⁾ 214555	1 Off	

AC operation

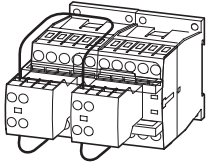

7	2.2	3	3.5	1	2.2	2.9	DIULM7/21(230V50HZ)²⁾ 278061	1 Off	
7	2.2	3	3.5	1	2.2	2.9	DIULM7/21(24VDC)²⁾ 107021	1 Off	
9	2.5	4	4.5	1.5	2.5	3.6	DIULM9/21(230V50HZ)²⁾ 278086	1 Off	
9	2.5	4	4.5	1.5	2.5	3.6	DIULM9/21(24VDC)²⁾ 107022	1 Off	
12	3.5	5.5	6.5	2	3	4.4	DIULM12/21(230V50HZ)²⁾ 278111	1 Off	
12	3.5	5.5	6.5	2	3	4.4	DIULM12/21(24VDC)²⁾ 107023	1 Off	

AC operation

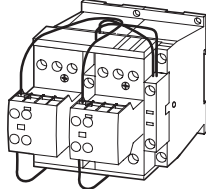

18	5	7.5	11	2.5	4.5	6.5	DIULM17/21(230V50HZ)²⁾ 278136	1 Off	
18	5	7.5	11	2.5	4.5	6.5	DIULM17/21(RDC24)²⁾ 107024	1 Off	
25	7.5	11	14	3.5	6	8.5	DIULM25/21(230V50HZ)²⁾ 278161	1 Off	
25	7.5	11	14	3.5	6	8.5	DIULM25/21(RDC24)²⁾ 107025	1 Off	
32	10	15	17	4	7	10	DIULM32/21(230V50HZ)²⁾ 278186	1 Off	
32	10	15	17	4	7	10	DIULM32/21(RDC24)²⁾ 107026	1 Off	
40	12.5	18.5	23	5	9	12	DIULM40/11(230V50HZ)²⁾ 278211	1 Off	
50	15.5	22	30	6	10	14	DIULM50/11(230V50HZ)²⁾ 278236	1 Off	
65	20	30	35	7	12	17	DIULM65/11(230V50HZ)²⁾ 278261	1 Off	

Information relevant for export to North America



¹⁾ Product Standards	IEC/EN 60947-4-1; UL 508; CSA-C22.2 No.14-05; CE marking
UL File No.	E29096
UL CCN	NLDX
CSA File No.	012528
CSA Class No.	3211-04
NA Certification	UL Listed, CSA certified

Information relevant for export to North America



²⁾ Product Standards	IEC/EN 60947-4-1; UL 508; CSA-C22.2 No.14-05; CE marking
UL File No.	E29096
UL CCN	NLDX
CSA File No.	012528
CSA Class No.	2411-03, 3211-04
NA Certification	UL Listed, CSA certified

Individual components of the combination Spare auxiliary contacts Circuit diagram **Notes**

Contactor Q11 Contactor Q12 Q11 Q12 Mechanical interlock

Part no. Part no.

DILEM-10 + 11DILEM	DILEM-10 + 11DILEM			+
DILEM-10-G + 11DILEM	DILEM-10-G + 11DILEM			+
DILM7-01 + DILA-XHI20	DILM7-01 + DILA-XHI20			+
DILM7-01 + DILA-XHI20	DILM7-01 + DILA-XHI20			+
DILM9-01 + DILA-XHI20	DILM9-01 + DILA-XHI20			+
DILM9-01 + DILA-XHI20	DILM9-01 + DILA-XHI20			+
DILM12-01 + DILA-XHI20	DILM12-01 + DILA-XHI20			+
DILM12-01 + DILA-XHI20	DILM12-01 + DILA-XHI20			+
DILM17-01 + DILA-XHI20	DILM17-01 + DILA-XHI20			+
DILM17-01 + DILA-XHI20	DILM17-01 + DILA-XHI20			+
DILM25-01 + DILA-XHI20	DILM25-01 + DILA-XHI20			+
DILM25-01 + DILA-XHI20	DILM25-01 + DILA-XHI20			+
DILM32-01 + DILA-XHI20	DILM32-01 + DILA-XHI20			+
DILM32-01 + DILA-XHI20	DILM32-01 + DILA-XHI20			+
DILM40 + DILM150-XHI11	DILM40 + DILM150-XHI11	-	-	+
DILM50 + DILM150-XHI11	DILM50 + DILM150-XHI11	-	-	+
DILM65 + DILM150-XHI11	DILM65 + DILM150-XHI11	-	-	+

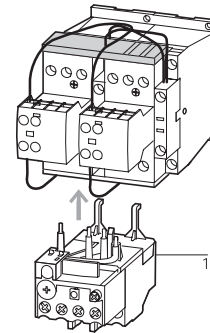
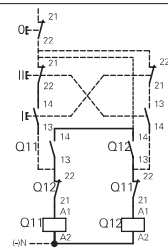
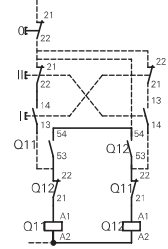
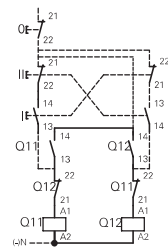

Accessories
1 Overload relay
Accessories

Page
→ 8
→ 52

Reversing contactors

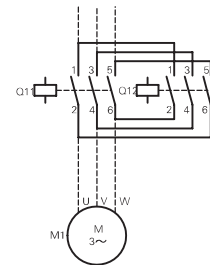

DIULM7/21 to DIULM65/11 with mechanical interlock

1 Ordering

DILM...-XSP... Suppressor circuits

RC suppressors



Voltage U_s V	For use with	Circuit symbol	Part no. Article no.	Price See price list	Std. pack	Notes
24 - 48 AC	DILM7 - DILM15 DILMP20		DILM12-XSPR48 281199		10 Off 	For AC operated contactors 50 - 60 Hz. DC operated contactors and DILM115 and DILM150 have an integrated suppressor. Note drop-out delay.
110 - 240 AC	DILA		DILM12-XSPR240 281200		10 Off 	
240 - 500 AC			DILM12-XSPR500 281201		10 Off 	
24 - 48 AC	DILM17 - DILM32 DILK12 - DILK25		DILM32-XSPR48 281202		10 Off 	
110 - 240 AC	DILL... DILMP32 - DILMP45		DILM32-XSPR240 281203		10 Off 	
240 - 500 AC			DILM32-XSPR500 281204		10 Off 	
24 - 48 AC	DILM40 - DILM95 DILK33 - DILK50		DILM95-XSPR48 281205		10 Off 	
110 - 240 AC	DILMP63 - DILMP200		DILM95-XSPR240 281206		10 Off 	
240 - 500 AC			DILM95-XSPR500 281207		10 Off 	

Varistor suppressors



24 - 48 AC	DILM7 - DILM15 DILMP20		DILM12-XSPV48 281208		10 Off 	For AC operated contactors 50 - 60 Hz. DC operated contactors and DILM115 and DILM150 have an integrated suppressor. Note drop-out delay.
48 - 130 AC	DILA		DILM12-XSPV130 281209		10 Off 	
130 - 240 AC			DILM12-XSPV240 281210		10 Off 	
240 - 500 AC		DILM12-XSPV500 281211		10 Off 		
24 - 48 AC	DILM17 - DILM32 DILK12 - DILK25		DILM32-XSPV48 281212		10 Off 	
48 - 130 AC	DILL... DILMP32 - DILMP45		DILM32-XSPV130 281213		10 Off 	
130 - 240 AC			DILM32-XSPV240 281214		10 Off 	
240 - 500 AC		DILM32-XSPV500 281215		10 Off 		
24 - 48 AC	DILM40 - DILM95 DILK33 - DILK50		DILM95-XSPV48 281216		10 Off 	
48 - 130 AC	DILMP63 - DILMP200		DILM95-XSPV130 281217		10 Off 	
130 - 240 AC			DILM95-XSPV240 281218		10 Off 	
240 - 500 AC		DILM95-XSPV500 281219		10 Off 		











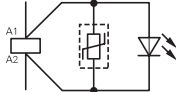



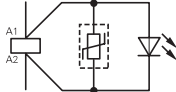

Information relevant for export to North America

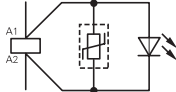

Product Standards	IEC/EN 60947-4-1; UL 508; CSA-C22.2 No.14-05; CE marking
UL File No.	E29096
UL CCN	NLDX
CSA File No.	227038
CSA Class No.	3211-07
NA Certification	UL Listed, CSA certified

Ordering

DILM...-XSP... Suppressor circuits











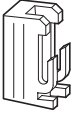

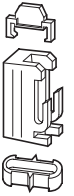

Voltage U_s V	For use with	Circuit symbol	Part no. Article no.	Price See price list	Std. pack	Notes
Varistor suppressors with integrated LED 	24 - 48 AC	DILM7 - DILM15 DILMP20		DILM12-XSPVL48 281220	10 Off  	For AC operated contactors 50 - 60 Hz. DC operated contactors and DILM115 and DILM150 have an integrated suppressor. Note drop-out delay.
	130 - 240 AC	DILA		DILM12-XSPVL240 281221	10 Off  	
	24 - 48 AC	DILM17 - DILM32 DILK12 - DILK25		DILM32-XSPVL48 281222	10 Off  	
	130 - 240 AC	DIL... DILMP32 - DILMP45		DILM32-XSPVL240 281223	10 Off  	
	24 - 48 AC	DILM40 - DILM95 DILK33 - DILK50		DILM95-XSPVL48 281224	10 Off  	
	130 - 240 AC	DILMP63 - DILMP200		DILM95-XSPVL240 281225	10 Off  	
Diode suppressor 	12 - 250 DC	DILM7 - DILM15 DILMP20 DILA		DILM12-XSPD 101672	10 Off  	DC operated contactors. Prevention of negative switch-off voltage when the contactor is used together with a safety PLC.

Information relevant for export to North America



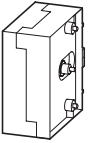































Product Standards	IEC/EN 60947-4-1; UL 508; CSA-C22.2 No.14-05; CE marking
UL File No.	E29096
UL CCN	NLDX
CSA File No.	227038
CSA Class No.	3211-07
NA Certification	UL Listed, CSA certified

1 DILM...XDILM...XVB, DILM...XMV

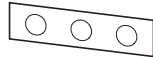
For use with	Part no.	Price See price list	Std. pack	Notes	Information relevant for export to North America 
Mechanical interlocks					
For mechanically linking contactors in combinations 0 mm distance between contactors.					
	DILM7 - DILM72 DILA	DILM32-XVB 281227	50 Off 	—	Product Standards IEC/EN 60947-4-1; UL 508; CSA-C22.2 No.14-05; CE marking E36332 UL File No. NLRV UL CCN 012528 CSA File No. 3211-05 CSA Class No. UL Listed, CSA certified NA Certification
	DILM80 - DILM170	DILM150-XVB 281226	10 Off 	—	Product Standards IEC/EN 60947-4-1; UL 508; CSA-C22.2 No.14-05; CE marking E29184 UL File No. NKCR UL CCN 012528 CSA File No. 3211-03 CSA Class No. UL Listed, CSA certified NA Certification
Mechanical interlocks					
	DILM7 - DILM15 DILMP20 DILA	DILM12-XMV 281196	1 Off 	For two contactors with AC or DC operation arranged vertically or horizontally. Distance between contactors 0 mm, including contactor connector	Product Standards IEC/EN 60947-4-1; UL 508; CSA-C22.2 No.14-05; CE marking E29096 UL File No. NLDX UL CCN 012528 CSA File No. 2411-03 CSA Class No. UL Listed, CSA certified NA Certification
	DILM17 - DILM38	DILM32-XMV 281197	1 Off 	Mechanical lifespan 2.5 x 10 ⁶ operations. DILM 150-XMV including mounting plate for contactors.	Product Standards IEC/EN 60947-4-1; UL 508; CSA-C22.2 No.14-05; CE marking E29096 UL File No. NLDX UL CCN 012528 CSA File No. 2411-03,3211-04 CSA Class No. UL Listed, CSA certified NA Certification
	DILM40 - DILM72	DILM65-XMV 281198	1 Off 	Additional auxiliary contact modules possible. →36	
	DILM80 - DILM170	DILM150-XMV 240081	1 Off 		Product Standards IEC/EN 60947-4-1; UL 508; CSA-C22.2 No.14-05; CE marking E29096 UL File No. NLDX UL CCN 012528 CSA File No. 2411-03 CSA Class No. UL Listed, CSA certified NA Certification
	DILM185A, DILM225A, DILM250, DILM300A, DILM400, DILM500, DILM570	DILM500-XMV 208289	1 Off 	For contactors with the same or different magnet systems mounted horizontally or vertically, mechanical lifespan 5 x 10 ⁶ operations. No auxiliary contact permitted between mechanical interlock and contactor. Combination only with consecutive installation sizes or DILM185A - DILM570.	Product Standards IEC/EN 60947-4-1; UL 508; CSA-C22.2 No.14-05; CE marking E29184 UL File No. NKCR UL CCN 012528 CSA File No. 3211-04 CSA Class No. UL Listed, CSA certified NA Certification
	DILM580, DILM650, DILM750, DILM820 DILM1000	DILM820-XMV 208288	1 Off 	For contactors with the same or different magnet systems mounted horizontally or vertically, mechanical lifespan 5 x 10 ⁶ operations. No auxiliary contact permitted between mechanical interlock and contactor. DILM820-XMV consists of interlock element and mounting plate.	Product Standards IEC/EN 60947-4-1; UL 508; CSA-C22.2 No.14-05; CE marking E29184 UL File No. NKCR UL CCN 012528 CSA File No. 3211-04 CSA Class No. UL Listed, CSA certified NA Certification
Set of spare parts for mechanical interlock					
Ball for mechanical interlock, incl. contactor connector.					
—	DILM80 - DILM170	DILM150-XMVE 107020	1 Off 		UL/CSA certification not required







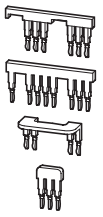

DILM...-XP1, DILM...-XS1

	For use with	Circuit symbol	Part no.	Price See price list	Std. pack	Notes	Information relevant for export to North America
Paralleling links for main contacts							
Consisting of 2 paralleling links							
	DILM7 - DILM15		DILM12-XP1 281193	5 Off	 	4th pole can be broken off AC-1 current carrying capacity of the open contactor increases by a factor of 2.5 Protected against accidental contact in accordance with VDE 0106 Part 100	Product Standards IEC/EN 60947-4-1; UL 508; CSA-C22.2 No.14-05; CE marking E29096
	DILM17 - DILM32		DILM32-XP1 281194	5 Off	 	A cover is included with DILM185-XP1 for protection against accidental contact.	UL File No. UL CCN CSA File No. CSA Class No. NA Certification
	DILM40 - DILM72		DILM65-XP1 281195	1 Off	 	Connection cross section for DILM...-XP1 Technical data	NLDX 012528 3211-03 UL Listed, CSA certified
	DILM80 - DILM170		DILM150-XP1 284769	1 Off	 		
	DILM185A		DILM185-XP1 208292	1 Off			—
Star-point bridges							
	DILM7 - DILM15		DILM12-XS1 281190	20 Off	 	<ul style="list-style-type: none"> Designed as tool-less plug connection Use as DILA-XHIT... contactor auxiliary contact → 38 	Product Standards IEC/EN 60947-4-1; UL 508; CSA-C22.2 No.14-05; CE marking E36332 UL File No. UL CCN CSA File No. CSA Class No. NA Certification
	DILM17 - DILM32		DILM32-XS1 281191	20 Off	 	<ul style="list-style-type: none"> Use as DILA-XHIT... contactor auxiliary contact → 38 	Product Standards IEC/EN 60947-4-1; UL 508; CSA-C22.2 No.14-05; CE marking E36332
	DILM40 - DILM72		DILM65-XS1 281192	10 Off	 	—	UL File No. UL CCN CSA File No. CSA Class No. NA Certification
	DILM80 - DILM170		DILM150-XS1 284768	5 Off	 	—	Product Standards IEC/EN 60947-4-1; UL 508; CSA-C22.2 No.14-05; CE marking E36332 UL File No. UL CCN CSA File No. CSA Class No. NA Certification
	DILM185A - DILM400		DILM400-XS1 208291	1 Off	 	A cover is included for protection against accidental contact.	Product Standards IEC/EN 60947-4-1; UL 508; CSA-C22.2 No.14-05; CE marking E36332 UL File No. UL CCN CSA File No. CSA Class No. NA Certification
	DILM500		DILM500-XS1 208290	1 Off	 	A cover is included for protection against accidental contact.	Product Standards IEC/EN 60947-4-1; UL 508; CSA-C22.2 No.14-05; CE marking E29096 UL File No. UL CCN NA Certification

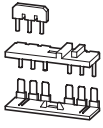
1

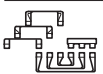
DILM...-XSL Star-delta wiring kit

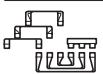
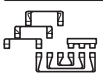
Main current wiring for star-delta combination Including star-point bridge

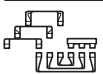
For use with	Part no.	Price See price list	Std. pack	Notes	Information relevant for export to North America	
 <p>DILM7/9/12/15 mains contactors DILM7/9/12/15 delta contactors DILM7/9/12/15 star contactors</p>	DILM12-XSL 283130		1 Off 	<ul style="list-style-type: none"> Designed for tool-less plug connection Use as DILA-XHIT... contactor auxiliary contact → 38 <p>The following control cables are integrated in addition to electrical interlock:</p> <ul style="list-style-type: none"> Q13: A1 - Q15: 21 Q13: 21 - Q15: A1 Q13: A2 - Q15: A2 	<p>Product Standards IEC/EN 60947-4-1; UL 508; CSA-C22.2 No.14-05; CE marking</p> <p>CSA File No. 012528</p> <p>CSA Class No. 3211-05</p> <p>NA Certification UL Listed, CSA certified</p>	
	 <p>DILM17/25/32 mains contactors DILM17/25/32 delta contactors DILM17/25/32 star contactors</p>	DILM32-XSL 283131		1 Off 	<p>Consists of the following connection bridges:</p> <ul style="list-style-type: none"> Mains - delta contactors Delta - star contactors Star-point bridge 	<p>Product Standards IEC/EN 60947-4-1; UL 508; CSA-C22.2 No.14-05; CE marking</p> <p>UL File No. E36332</p> <p>UL CCN NLRV</p> <p>CSA File No. 012528</p> <p>CSA Class No. 3211-04</p> <p>NA Certification UL Listed, CSA certified</p>
		 <p>DILM40/50/65 mains contactors DILM40/50/65 delta contactors DILM40/50/65 star contactors</p>	DILM65-XSL 101058		1 Off 	
	 <p>DILM 80/95 mains contactors DILM80/95 delta contactors DILM50/65 star contactors</p>		DILM95-XSL 101486		1 Off	
 <p>DILM 115/150 mains contactors DILM115/150 delta contactors DILM80/95/115 star contactors</p>		DILM150-XSL 101487		1 Off 		<p>Product Standards IEC/EN 60947-4-1; UL 508; CSA-C22.2 No.14-05; CE marking</p> <p>UL File No. E36332</p> <p>UL CCN NLRV</p> <p>CSA File No. 012528</p> <p>CSA Class No. 2411-03,3211-04</p> <p>NA Certification UL Listed, CSA certified</p>
	 <p>DILM 185/225 mains contactors DILM185/225 delta contactors DILM115/150 star contactors</p>	DILM225-XSL 101488		1 Off		

**DILM...-XRL, DILM...XIP2X
Reversing starter wiring kits**

Main current wiring for reversing combinations

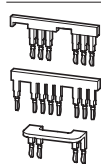

For use with	Part no.	Price See price list	Std. pack	Notes	Information relevant for export to North America
DILM7 DILM9 DILM12	DILM12-XRL 283108		1 Off 	<ul style="list-style-type: none"> Designed for tool-less plug connection As auxiliary contact DILA-XHIT...use → 38 The following control cables are integrated in addition to electrical interlock: <ul style="list-style-type: none"> Q11: A1 - Q12: 21 Q11: 21 - Q12: A1 Q11: A2 - Q12: A2 	Product Standards IEC/EN 60947-4-1; UL 508; CSA-C22.2 No.14-05; CE marking UL File No. E36332 UL CCN NLRV CSA File No. 012528 CSA Class No. 3211-05 NA Certification UL Listed, CSA certified
DILM17 DILM25 DILM32	DILM32-XRL 283109		1 Off 	—	Product Standards IEC/EN 60947-4-1; UL 508; CSA-C22.2 No.14-05; CE marking UL File No. E36332 UL CCN NLRV CSA File No. 012528 CSA Class No. 3211-04 NA Certification UL Listed, CSA certified
DILM40 DILM50 DILM65	DILM65-XRL 101057		1 Off 	—	Product Standards IEC/EN 60947-4-1; UL 508; CSA-C22.2 No.14-05; CE marking UL File No. E36332 UL CCN NLRV CSA File No. 012528 CSA Class No. 2411-03, 3211-04 NA Certification UL Listed, CSA certified
DILM80 DILM95 DILM115 DILM150	DILM150-XRL 101681		1 Off 	—	Product Standards IEC/EN 60947-4-1; UL 508; CSA-C22.2 No.14-05; CE marking UL File No. E36332 UL CCN NLRV CSA File No. 012528 CSA Class No. 2411-03, 3211-04 NA Certification UL Listed, CSA certified

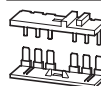

**DILM...-XRL, DILM...XIP2X
IP2X cover set**

For use with	Part no.	Price See price list	Std. pack	Notes	Information relevant for export to North America
DILM17 DILM25 DILM32 DILM38 DILMP32 DILMP45	DILM32-XIP2X 118855		1 Off 	Each cover set consists of two three-pole and two single-pole covers.	UL/CSA certification not required
DILM40 DILM50 DILM65 DILM72 DILMP63 DILMP80	DILM65-XIP2X 106491		8 Off 	2 covers are required per phase The cover set consists of 8 covers	UL/CSA certification not required
DILM80 DILM95 DILM115 DILM150 DILM170 DILMP125 DILMP160 DILMP200 ZB150	DILM150-XIP2X 106492		8 Off 		UL/CSA certification not required

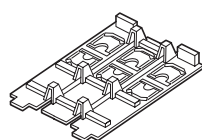

1

DILM12-XDSBS Three-phase commoning links

Protected against accidental contact, short-circuit proof, $U_e = 690\text{ V}$, $I_u = 35\text{ A}$ Can be extended by rotating by mounting



For use with	Part no.	Price See price list	Std. pack	Notes	Information relevant for export to North America
DILM7 DILM9 DILM12 DILM15	DILM12-XDSB0/3 240084		5 Off 	Suitable for 3 contactors. Length 112 mm	Product Standards IEC/EN 60947-4-1; UL 508; CSA-C22.2 No.14-05; CE marking UL File No. E36332 UL CCN NLRV CSA File No. 012528 CSA Class No. 2411-03 NA Certification UL Listed, CSA certified
DILM7 DILM9 DILM12 DILM15	DILM12-XDSB0/4 240085		5 Off 	Suitable for 4 contactors. Length 157 mm	
DILM7 DILM9 DILM12 DILM15	DILM12-XDSB0/5 240086		5 Off 	Suitable for 5 contactors. Length 202 mm	

DILM12-XDSBS Incoming connection block

For use with

Part no.	Price See price list	Std. pack	Notes	Information relevant for export to North America
----------	----------------------------	-----------	-------	--

DILM7 DILM9 DILM12 DILM15	DILM12-XEK 240083		5 Off 	For three-phase commoning link, protected against accidental contact, $U_e = 690\text{ V}$, $I_u = 35\text{ A}$. Terminal capacities: Stranded 2.5...16 mm ² Flexible with ferrule 2.5...16 mm ² AWG14...8	Product Standards IEC/EN 60947-4-1; UL 508; CSA-C22.2 No.14-05; CE marking UL File No. E36332 UL CCN NLRV CSA File No. 012528 CSA Class No. 2411-03 NA Certification UL Listed, CSA certified
------------------------------------	-----------------------------	--	-----------	--	--

DILM12-XDSBS Adapter plate

Enables clipping on of switches on to DIN rails



For use with	Part no.	Price See price list	Std. pack	Notes	Information relevant for export to North America
DILM80 DILM95 DILM115 DILM150 DILM170	NZM2-XC75 260215		1 Off 	For top-hat rail 75 mm	Product Standards IEC/EN 60947-4-1; UL 489; CSA-C22.2 No.14-05; CE marking UL File No. E140305 UL CCN DIHS CSA File No. 022086 CSA Class No. 1437-01 NA Certification UL Listed, CSA certified

DILM32-XTE
Electronic timer modules

On-delayed, Cannot be combined with top mounting auxiliary contacts Incl. suppressor circuits

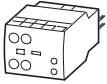

Off-delayed, auxiliary voltage-free Cannot be combined with top mounting auxiliary contacts Incl. suppressor circuits

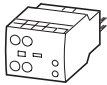

For star-delta applications Cannot be combined with top mounting auxiliary contacts Incl. suppressor circuits

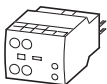

	For use with	Circuit symbol	Part no. Article no.	Price See price list	Std. pack	Notes	
24 V AC/DC	DILM7 - DILM32 DILMP20		DILM32-XTEE11(RA24) 101440		1 Off 	Time range can be selected	
100 ... 130 V AC	DILMP32-DILMP45 DILA		DILM32-XTEE11(RAC130) 101441		1 Off 	0.05 s...1 s 0.5 s...10 s 5 s...100 s	
200 ... 240 V AC			DILM32-XTEE11(RAC240) 101442		1 Off 		
24 V AC/DC	DILM7 - DILM32 DILMP20		DILM32-XTED11-1(RA24) 105210		1 Off 	Time range 0.05 s...1 s	
24 V AC/DC	DILMP32-DILMP45 DILA		DILM32-XTED11-10(RA24) 104943		1 Off 	Time range 0.5 s...10 s	
24 V AC/DC			DILM32-XTED11-100(RA24) 104946		1 Off 	Time range 5 s...100 s	
100 ... 130 V AC			DILM32-XTED11-1(RAC130) 105211		1 Off 	Time range 0.05 s...1 s	
100 ... 130 V AC			DILM32-XTED11-10(RAC130) 104944		1 Off 	Time range 0.5 s...10 s	
100 ... 130 V AC			DILM32-XTED11-100(RAC130) 104947		1 Off 	Time range 5 s...100 s	
200 ... 240 V AC			DILM32-XTED11-1(RAC240) 105212		1 Off 	Time range 0.05 s...1 s	
200 ... 240 V AC			DILM32-XTED11-10(RAC240) 104945		1 Off 	Time range 0.5 s...10 s	
200 ... 240 V AC			DILM32-XTED11-100(RAC240) 104948		1 Off 	Time range 5 s...100 s	
24 V AC/DC	DILM7 - DILM32 DILMP20			DILM32-XTEY20(RA24) 101446		1 Off 	Changeover time 1...30 s
100 ... 130 V AC	DILMP32-DILMP45 DILA			DILM32-XTEY20(RAC130) 101447		1 Off 	50 ms changeover delay
200 ... 240 V AC				DILM32-XTEY20(RAC240) 101448		1 Off 	Sample circuit → Page 92

Information relevant for export to North America



Product Standards	IEC/EN 60947-4-1; UL 508; CSA-C22.2 No.14-05; CE marking
UL File No.	E29184
UL CCN	NKCR
CSA File No.	012528
CSA Class No.	3211-03
NA Certification	UL Listed, CSA certified

1.11

Contactor relays, contactors

Accessories

1

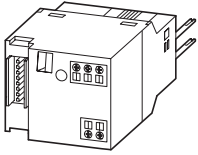

DIL-SWD..., DILM12-XMC SWD contactor modules

SmartWire-Darwin module for installation on contactors. One module per contactor

	For use with	Part no. Article no.	Price See price list	Std. pack	Notes
Two digital inputs for potential-free contacts. 1 electrical interlock for the surface mounting of reversing starters. Messages: Contactor switch status, status of the digital inputs 1 and 2. Commands: Contactor actuation	DILM(C)7... - DILM(C)32 DILM38 DILA	DIL-SWD-32-001¹⁾ 118560		5 Off 	<ul style="list-style-type: none"> Take into account the max. current consumption of the contactor coils per SmartWire-Darwin line. A2 terminals must not be bridged. Wiring sets DILM 12-XRL and PKZM0-XRM12 cannot be used. Connection terminals for electrical interlocking are not suitable for safety technology.
Two digital inputs for potential-free contacts. 1 electrical interlock for the surface mounting of reversing starters. 1-0-A switch for manual or automatic operation. Messages: contactor switching position, status of the digital inputs 1 and 2, 1-0-A switch position. Commands: Contactor actuation	DILM(C)7... - DILM(C)32 DILM38 DILA	DIL-SWD-32-002¹⁾ 118561		5 Off 	

DIL-SWD..., DILM12-XMC Wiring set for motor feeder plug









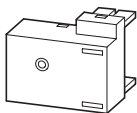

	For use with	Part no. Article no.	Price See price list	Std. pack	Notes
PE module with contact plate	DILM(C)7 DILM(C)9 DILM(C)12 DILM(C)15	DILM12-XMCE²⁾ 121764		5 Off 	35x7.5 (15) mm mounting rail (as per DIN EN 60715) with PE function required. For connection of: PE 0.75 – 4 mm ²
Motor plate with PE module and contact plate	DILM(C)7 DILM(C)9 DILM(C)12 DILM(C)15	DILM12-XMCP/E²⁾ 121769		1 Off 	35x7.5 (15) mm mounting rail (as per DIN EN 60715) with PE function required. For connection of: L1, L2, L3, PE 0.75 – 2.5 mm ²
Motor plate with PE module and contact plate	PKZM0/PKE + DILM(C)7 PKZM0/PKE + DILM(C)9 PKZM0/PKE + DILM(C)12 PKZM0/PKE + DILM(C)15 MSC-D(E)-...-M7... MSC-D(E)-...-M9... MSC-D(E)-...-M15...	DILM12-XMCP/T²⁾ 121770		1 Off 	For connection of: L1, L2, L3, PE 0.75 – 2.5 mm ²

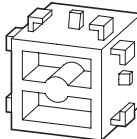
Information relevant for export to North America

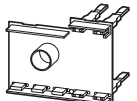

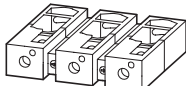

- 1) NA Certification Request filed for UL and CSA
 2) Product Standards IEC/EN 60947-4-1; UL 508; CSA-C22.2 No. 14-05; CE marking
 NA Certification Request filed for UL and CSA

DILM...-X...

	For use with	Part no. Article no.	Price See price list	Std. pack	Notes	Information relevant for export to North America 
Motor suppressor module						
Can be used at 380...575 V 50/60 Hz.						
	DILM7 - DILM15	DILM12-XMSM 109399		4 Off 	<ul style="list-style-type: none"> • Tool-less version using tool-less plug connection • RC suppressor • Ambient temperature -25...+60 °C, open. • Insulated material, difficult to ignite according to UL 94. • Weight = 0.05 kg. • UL/CSA approval applied for 	Product Standards IEC/EN 60947-4-1; UL 508; CE marking E300273 NMTR2 UL Listed UL File No. UL CCN NA Certification
Test block						
Suitable for switching on contactor off-load						
	DILM7 - DILM38 DILA	DILM32-XMAN 110955		1 Off 	-	UL/CSA certification not required
Printed board contact						
For the adaption of a control circuit on a printed-circuit board						
	DILM7 - DILM15 DILA	DILM12-XPBC 109400		4 Off	-	-
Load resistor						
For DC contactors in order to increase power consumption						
	DILM17 DILM25 DILM32 DILM38 DILMP32 DILMP45	DILM32-XSPLW24 112419		1 Off 	Installed in a suppressor circuit enclosure. Required when using special PLC outputs for actuation, e.g.: Beckhoff safety controllers.	Product Standards IEC/EN 60947-4-1; CSA-C22.2 No.14-05; CE marking 225135 3211-07 CSA certified CSA File No. CSA Class No. NA Certification
Extension terminals						
	DILM80 DILM95 DILM115 DILM150 DILM170	DILM150-XZK 104486		10 Off 	Can be fitted on every main terminal of the contactor. Connection options: maximum 2 x 4 mm ² solid maximum 2 x 2.5 mm ² flexible with ferrule	Product Standards IEC/EN 60947-4-1; UL 508; CSA-C22.2 No.14-05;CE marking E29184 UL File No. UL CCN CSA File No. CSA Class No. NA Certification UL Listed, CSA certified
Cable terminal block						
With control circuit terminal Consisting of three flat ribbon terminals						
	DILM250 DILM300A DILM400	DILM400-XKU-S 208293		1 Off 	Connection options: round conductors, flexible and stranded, ribbon cables.	Product Standards IEC/EN 60947-4-1; UL 508; CSA-C22.2 No.14-05;CE marking E29184 UL File No. UL CCN CSA File No. CSA Class No. NA Certification UL Listed, CSA certified

DILM...-XK... Flat strip conductor terminal kit



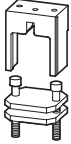

With control cable connection

For use with	Part no. Article no.	Price See price list	Std. pack	Notes	Information relevant for export to North America
DILM580 DILM650 DILM750 DILM820	DILM820-XKB-S 208295		1 Off	Connection options: ribbon cables	 













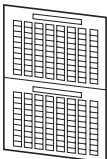

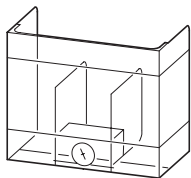



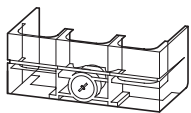

DILM...-XK... Connection terminal sets for North America

Consist of three individual terminals

Conductor material	Cross-section X number of cores mm ²	For use with	Part no. Article no.	Price See price list	Std. pack	Notes	Information relevant for export to North America
Copper, aluminum	2 x (AWG4 ... MCM500)	DILM500/22	DILM500-XK-CNA 232192		1 Off  	Including cover With control cable connec- tion	Product Standards IEC/EN 60947-4-1; UL 508; CSA-C22.2 No.14-05; CE marking E29184 NKCR 012528 3211-04 UL Listed, CSA certified
Copper, aluminum	4 x (AWG2 ... MCM500)	DILM580/22 DILM650/22 DILM750/22 DILM820/22	DILM820-XK-CNA 232194		1 Off  		

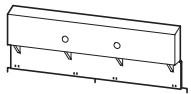
DILM...-XHB, DILM...-XAB

Description	For use with	Part no. Article no.	Price See price list	Std. pack	Notes	Information relevant for export to North America 
Sealable shrouds						
Transparent						
	DILM32-XTE...	DILM32-XTEPLH 101449		1 Off	–	–
Device labelling, label sheet						
7,5 x 17 mm Colour: yellow HKS 3 (≈ RAL 1018)						
	Labelling with laser printer, plotter, film plotter, copier	XGKE-GE 207517		25 Off 	1 off = 1 sheet 240 labels per sheet 1 sheet = DIN A4, Can be split into two DIN A5 sheets	UL/CSA certification not required
Covers						
Terminal cover						
	DILM185A	DILM225A-XHB 139560		1 Off 	To provide terminals with protection against accidental contact vertical from the front	UL/CSA certification not required
	DILM250	DILM400-XHB 208287		1 Off 		
	DILM300A					
	DILM400					
	DILM500	DILM500-XHB 208286		1 Off 		
	DILM580	DILM650-XHB 208285		1 Off 		
	DILM750	DILM820-XHB 208284		1 Off 		
	DILM820, DILM1000					
Shroud for star-point bridge						
	DILM400-XS1	DILM400-XHBS1 101687		1 Off 	Can be combined with star-delta wiring kits DILM250-XSL and DILM400-XSL.	UL/CSA certification not required
Auxiliary contact seat cover						
	DILM7 - DILM38 DILMP32 DILMP45 DILA DILL	DILM32-XAB 129538		10 Off 	For preventing manual actuation. Cannot be combined with additional surface mounting accessories	UL/CSA certification not required
	DILM40 - DILM170 DILMP63 - DILMP200	DILM150-XAB 121712		10 Off 		
Suppressor circuits for vacuum contactors (on load side)						
	DILM580 DILM650 DILM750 DILM820 DILM1000	DILM1000-XSM 125947		1 Off 	For damping the cutout overvoltage when switching off inductive loads.	NA Certification Request filed for UL and CSA
	DILH2000 DILH2200 DILH2600	DILH2600-XSM 125946		1 Off 		

1

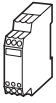

DILM...-XSP... Amplifier module for separate mounting

Input with integrated suppressor circuit for overvoltage limitation

Rated operational current		Actuating voltage	Actuating current	Circuit symbol	For use with	Part no.	Price	Std. pack	Information relevant for export to North America
AC-15	DC						See price list		
230 V	400 V	220 V							
I_e	I_e	I_e	U_s						
A	A	A	V DC						
2	2	0.03	24	25					

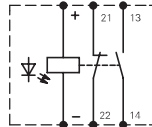

...DILM
D1MLP...
DILL...
DILK...

ETS4-VS3
083094

1 Off

Product Standards IEC/EN 60947-4-1; UL 508; CSA-C22.2 No.14-05; CE marking E36332
UL File No. NLRV
UL CCN 012528
CSA File No. 2411-03, 3211-04
CSA Class No. 2411-03, 3211-04
NA Certification UL Listed, CSA certified

Notes

Contactor coils with rated operational current > 2 A must be actuated via the DILER-G mini contactor relay.
Rated operational current DC:
Making and breaking conditions DC-13, time L/R 300ms



DILM...-XSP... Individual coils

For use with	Part no. Article no.	DC voltage	Prices See price list	Part no. Article no.	AC voltage	Price See price list	Std. pack	Notes
DILM17 DILM25 DILM32 DILM38	DILM32-XSP(RDC24) ¹⁾ 281155			DILM32-XSP(230V50HZ,240V60HZ) 281141			1 Off 	For additional actuating voltages → Page 75
DILM40 DILM50 DILM65 DILM72	DILM65-XSP(RDC24) ¹⁾ 281185			DILM65-XSP(230V50HZ,240V60HZ) 281171			1 Off 	
DILM80 DILM95	DILM95-XSP(RDC24) ¹⁾ 230080			DILM95-XSP(230V50HZ,240V60HZ) 230062			1 Off 	
DILM115 DILM150 DILM170	DILM150-XSP(RDC24) ¹⁾ 230115			DILM150-XSP(RAC240) ¹⁾ 230112			1 Off 	
DILM185A DILM225A	DILM225A-XSP(RDC24) ¹⁾ 139568			DILM225A-XSP(RAC240) ¹⁾ 139565			1 Off 	

Notes

¹⁾ Incl. electronic module

Information relevant for export to North America



Product Standards IEC/EN 60947-4-1; UL 508; CSA-C22.2 No.14-05; CE marking
UL File No. E29096
UL CCN NLDX
CSA File No. 012528
CSA Class No. 2411-03, 3211-04
NA Certification UL Listed, CSA certified

DILM...-XSP/E...
Electronic modules including coils

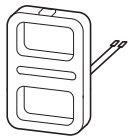
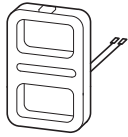

For use with	DC voltage Part no. Article no.	Price See price list	AC voltage Part no. Article no.	Price See price list	Std. pack	Notes
DILM250 DILM300A	DILM250-XSP/E(RA250) ¹⁾ 208252		DILM250-XSP/E(RA250) ¹⁾ 208252		1 Off 	For additional actuating voltages → Page 77
DILM400 DILM500	DILM500-XSP/E(RA250) ¹⁾ 208256		DILM500-XSP/E(RA250) ¹⁾ 208256		1 Off 	
DILM580 DILM650 DILM750 DILM820 DILM1000	DILM1000-XSP/E(RA250) ¹⁾ 289145		DILM1000-XSP/E(RA250) ¹⁾ 289145		1 Off 	
DILH1400	—		DILH1400-XSP/E(RAW250) ²⁾ 289161		1 Off 	
DILM250-S DILM300A-S	—		DILM250-S-XSP/E(220-240V50/60HZ) ²⁾ 274202		1 Off 	
DILM400-S DILM500-S	—		DILM500-S-XSP/E(220-240V50/60HZ) ²⁾ 274205		1 Off 	

1)

Information relevant for export to North America



Product Standards	IEC/EN 60947-4-1; UL 508; CSA-C22.2 No.14-05; CE marking
UL File No.	E29096
UL CCN	NLDX
CSA File No.	1017510
CSA Class No.	3211-04
NA Certification	UL Listed, CSA certified

2)

Information relevant for export to North America



Product Standards	IEC/EN 60947-4-1; UL 508; CSA-C22.2 No.14-05; CE marking
UL File No.	E29096
UL CCN	NLDX
CSA File No.	012528
CSA Class No.	3211-04
NA Certification	UL Listed, CSA certified

1.12 Contactor monitoring devices

1 Description, ordering



General

For safety-related off switching to safety category 3 and 4 according to EN 954-1, at present two contactors must be used in series. Especially with larger contactors this is an expensive solution.

Application

This is where the CMD can be used. The function of the CMD is to monitor the main contacts of a contactor against welding. For this the control voltage of the contactor is compared with the state of the main contacts which is reliably monitored using a mirror contact (IEC EN 60947-4-1 Annex F). If the coil is de-energized and the contactor does not drop out the CMD trips the upstream circuit-breaker/motor protective circuit breaker/switch-disconnector via a shunt release.

Safety

The CMD has a safety-compliant design so that in safety combinations with a circuit-breaker/motor protective circuit breaker/switch disconnector the reliable switch off in the case of a "welded contactor" can be guaranteed. In this application it replaces the series connection of a second contactor. As a component it conforms to safety category 3 according to EN 954-1 and EN ISO 13849.

Mounting

The CMD can be combined with the following Eaton components:

- Contactors:
 - DILEM
 - DILM7 to DILM150
 - DILM185(-S) to DILM500(-S):
 - DILM580 to DILM1600
 - DILH1400 ... DILH2000
 - SE-1A-PKZ2 and S-PKZ2
- Motor-protective circuit-breakers/ circuit-breakers:
 - PKZ2 + U-PKZ2(18VDC)
 - NZM1 + NZM1-XUVL
 - NZM2 + NZM2/3-XUV
 - NZM3 + NZM2/3-XUV
 - NZM4 + NZM4-XUV
 - N1 + NZM1-XUVL
 - N2 + NZM2/3-XUV
 - N3 + NZM2/3-XUV
 - N4 + NZM4-XUV

For the wiring of the CMD the auxiliary N/C contact, mirror contact must be according to IEC/EN 60947-4-1 and the auxiliary N/O contact must be interlocked and opposing according to IEC/EN 60947-5-1. Also the auxiliary N/C contact for the feedback circuit must have a mirror contact function according to IEC/EN 60947-4-1.

Auxiliary contact requirements per contactor:

	CMD	Self maintaining	Feedback circuit	Electrical interlock
DOL starter	1 N/O + 1 N/C	1S	1 B	
Reversing starter	1 N/O + 1 N/C	1S	1 B	1 B

Ordering

CMD contactor monitoring device

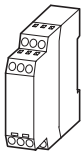

CMD

Part no. Article no.	Price See Price List	Std. pack
CMD(24VDC) 106170		1 Off
CMD(220-240VAC) 106172		1 Off

Engineering

1

DOL starter

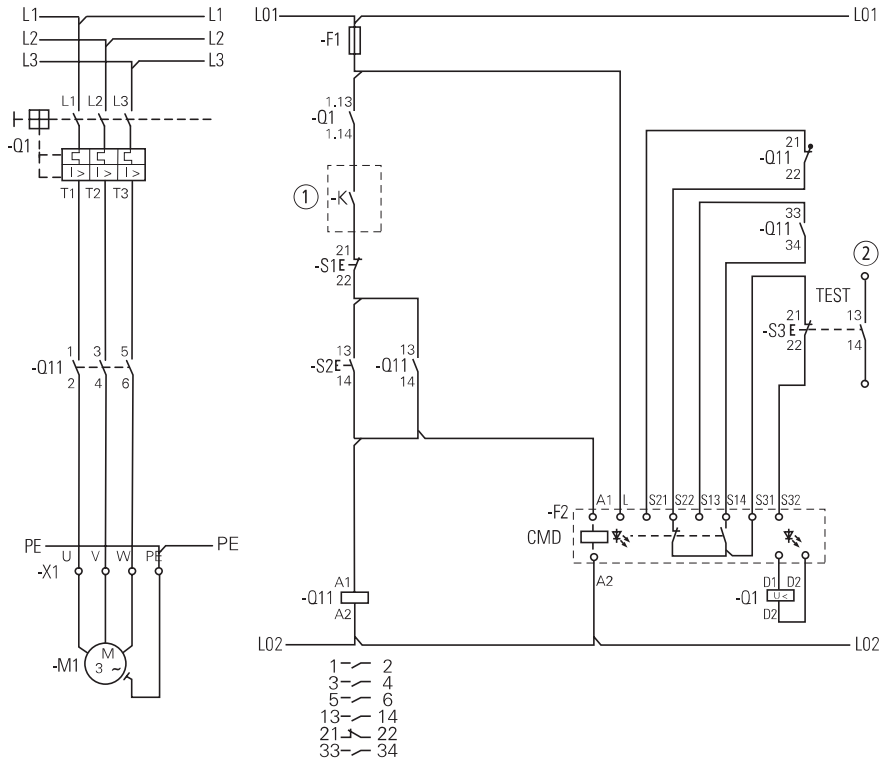

Reversing starter

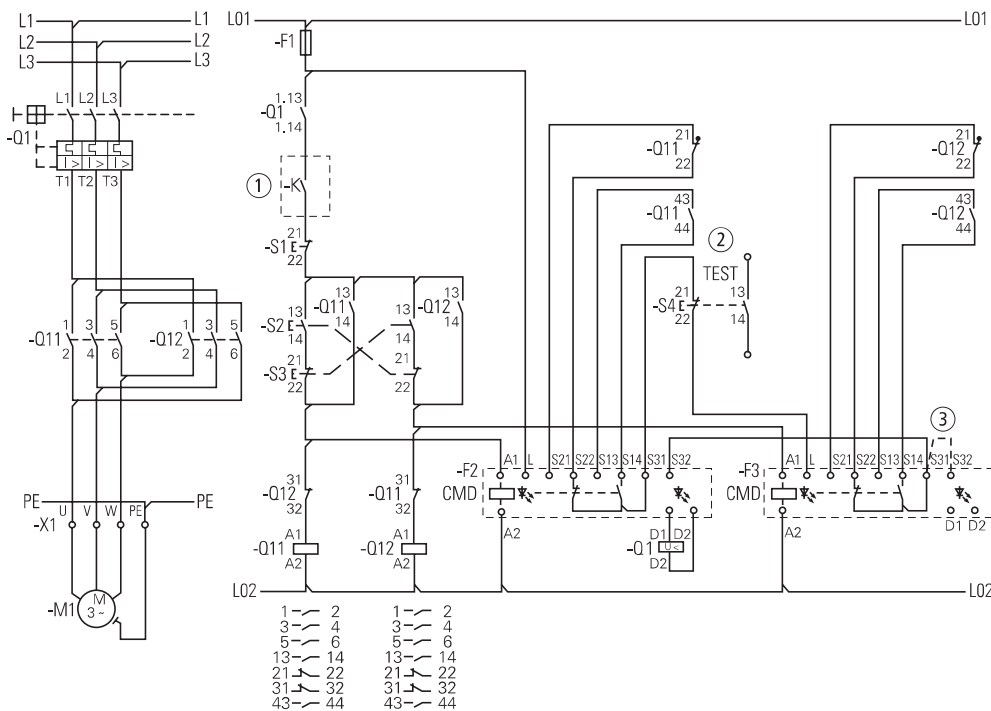

- ① Switching by safety relay of safety PLC
- ② Signal contact to PLC evaluation
- ③ CMD (24VDC)

1.12

Mini contactor relays, contactor relays Actuating voltages

1 Ordering

DILER, DILEEM

AC	DILER-40(...)	DILER-31(...)	DILER-22(...)	DILEEM-10(...)	DILEEM-01(...)
	Article no. ¹⁾	Article no. ¹⁾	Article no. ¹⁾	Article no. ¹⁾	Article no. ¹⁾
Standard voltages	See price list	See price list	See price list	See price list	See price list
24V 50Hz	010094	010251	010344	051604	051629
48V 50Hz	010190	010044	010201	051603	051628
240V 50Hz	010478	010300	010138	051602	051627
115V 60Hz	010270	010204	010211	051598	051624
42V 50Hz, 48V 60Hz	–	–	–	051612	051637
110V 50Hz, 120V 60Hz	051756	051765	051774	051611	051636
190V 50Hz, 220V 60Hz	051757	051766	051775	051610	051635
220V 50Hz, 240V 60Hz	051758	051767	051776	051609	051634
230V 50Hz, 240V 60Hz	051759	051768	051777	051608	051633
380V 50Hz, 440V 60Hz	051760	051769	051778	051607	051632
400V 50Hz, 440V 60Hz	051761	051770	051779	051606	051631
415V 50Hz, 480V 60Hz	051762	051771	051780	051605	051630
24V 50/60Hz	021924	021594	021704	051596	051621
42V 50/60Hz	033459	029869	029433	051595	051620
110V 50/60Hz	021961	021624	021871	051592	051618
230V 50/60Hz	052725	052509	052508	056674	058771

DILER, DILEEM

DC	DILER-40-G(...)	DILER-31-G(...)	DILER-22-G(...)	DILEEM-10-G(...)	DILEEM-01-G(...)
	Article no. ¹⁾	Article no. ¹⁾	Article no. ¹⁾	Article no. ¹⁾	Article no. ¹⁾
Standard voltages	See price list	See price list	See price list	See price list	See price list
12V DC	079711	079761	080728	051644	051649
24V DC	010223	010157	010042	051643	051650
48V DC	010255	010205	010346	051642	051648
110V DC	010287	010253	010043	051640	051646
220V DC	010303	010269	010091	051639	051645

Notes

¹⁾ To obtain the article number for ordering, read under selected part number and actuating voltage from the table.
Devices with dual-voltage coils are to be ordered under a single article number.

DILEM

AC	DILEM-10(...)	DILEM-01(...)	DILEM12-10(...)	DILEM12-01(...)	DILEM4(...)
	Article no. ¹⁾ See price list	Article no. ¹⁾ See price list	Article no. ¹⁾ See price list	Article no. ¹⁾ See price list	Article no. ¹⁾ See price list
Standard voltages					
24V 50Hz	010005	010086	127067	127083	014754
48V 50Hz	010020	010294	–	–	–
240V 50Hz	010032	010151	–	–	014305
115V 60Hz	010024	010470	–	–	–
42V 50Hz, 48V 60Hz	051782	051791	–	–	–
110V 50Hz, 120V 60Hz	051783	051792	127072	127088	051801
190V 50Hz, 220V 60Hz	051784	051793	–	–	–
220V 50Hz, 240V 60Hz	051785	051794	–	–	051803
230V 50Hz, 240V 60Hz	051786	051795	–	–	051804
380V 50Hz, 440V 60Hz	051787	051796	–	–	–
400V 50Hz, 440V 60Hz	051788	051797	–	–	051806
415V 50Hz, 480V 60Hz	051789	–	–	–	–
24V 50/60Hz	021417	020402	127079	127095	022044
42V 50/60Hz	032174	033233	–	–	–
110V 50/60Hz	021455	020436	127081	127097	–
230V 50/60Hz	052302	051114	127082	127098	052506

DILEM

DC	DILEM-10-G(...)	DILEM-01-G(...)	DILEM12-10-G(...)	DILEM12-01-G(...)	DILEM4-G(...)
	Article no. ¹⁾ See price list	Article no. ¹⁾ See price list	Article no. ¹⁾ See price list	Article no. ¹⁾ See price list	Article no. ¹⁾ See price list
Standard voltages					
12V DC	079594	079642	–	–	079680
24V DC	010213	010343	127132	127137	012701
48V DC	010245	010496	–	–	–
110V DC	010309	010136	–	–	–
220V DC	010325	010168	–	–	–

Notes

¹⁾ To obtain the article number for ordering, read under selected part number and actuating voltage from the table. Devices with **dual-voltage coils** are to be ordered under a **single** article number.

1.12

Contactors relays

Actuating voltages

1 DILA

AC

	With screw terminals			With Spring-loaded terminals		
	DILA-40(...)	DILA-31(...)	DILA-22(...)	DILAC-40(...)	DILAC-31(...)	DILAC-22(...)
	Article no. ¹⁾	Article no. ¹⁾	Article no. ¹⁾	Article no. ¹⁾	Article no. ¹⁾	Article no. ¹⁾
Standard voltages	See price list	See price list	See price list	See price list	See price list	See price list
24V 50Hz	276316	276351	276386	276431	276463	276495
240V 50Hz	276318	276353	276388	–	–	–
110V 50Hz 120V 60Hz	276326	276361	276396	276438	276470	276502
190V 50Hz 220V 60Hz	276327	276362	276397	–	–	–
220V 50Hz 240V 60Hz	276328	276363	276398	–	–	–
230V 50Hz 240V 60Hz	276329	276364	276399	276441	276473	276505
380V 50Hz 440V 60Hz	276330	276365	276400	–	–	–
400V 50Hz 440V 60Hz	276331	276366	276401	–	–	–
24V 50Hz/60Hz	276333	276368	276403	276445	276477	276509
42V 50Hz/60Hz	276334	276369	276404	–	–	–
110V 50Hz/60Hz	276335	276370	276405	–	–	–
220V 50Hz/60Hz	276336	276371	276406	–	–	–
230V 50Hz/60Hz	276337	276372	276407	276449	276481	276513
Special voltages other than the already shown normal voltages ²⁾	See price list	See price list	See price list	See price list	See price list	See price list
... V 50Hz(12-500V)³⁾	276341	276376	276411	276453	276485	276517
... V 60Hz(12-600V)³⁾	276342	276377	276412	276454	276486	276518

DILA

DC

	With screw terminals			With Spring-loaded terminals		
	DILA-40(...)	DILA-31(...)	DILA-22(...)	DILAC-40(...)	DILAC-31(...)	DILAC-22(...)
	Article no. ¹⁾	Article no. ¹⁾	Article no. ¹⁾	Article no. ¹⁾	Article no. ¹⁾	Article no. ¹⁾
Standard voltages	See price list	See price list	See price list	See price list	See price list	See price list
24V DC	276344	276379	276414	276456	276488	276520
48V DC	276345	276380	276415	–	–	–
110V DC	276347	276382	276417	276459	276491	276523
220V DC	276348	276383	276418	276460	276492	276524
Special voltages other than the already shown normal voltages ²⁾	See price list	See price list	See price list	See price list	See price list	See price list
... V DC(12-250V)³⁾	276349	276384	276419	276461	276493	276525

Notes

¹⁾ The article number is a combination of part no. and operating voltage devices with dual-voltage coils can be ordered under a single article no.

²⁾ With non-standard voltages the required actuating voltage from the defined range (...-...V) must be stated.

³⁾ Minimum order quantity 10 units

DILM

AC

	DILM7-10 (...)	DILM7-01 (...)	DILM9-10 (...)	DILM9-01 (...)	DILM12-10 (...)	DILM12-01 (...)	DILM15-10 (...)	DILM15-01 (...)
	Article no. ¹⁾	Article no. ¹⁾	Article no. ¹⁾	Article no. ¹⁾	Article no. ¹⁾	Article no. ¹⁾	Article no. ¹⁾	Article no. ¹⁾
Standard voltages	See price list	See price list	See price list	See price list	See price list	See price list	See price list	See price list
24V 50Hz	276537	276572	276677	276712	276817	276852	290045	290080
240V 50Hz	276539	276574	276679	276714	276819	276854	–	–
42V 50Hz 48V 60Hz	276546	–	276686	–	276826	–	–	–
110V 50Hz 120V 60Hz	276547	276582	276687	276722	276827	276862	290055	290090
190V 50Hz 220V 60Hz	276548	276583	276688	276723	276828	276863	–	–
220V 50Hz 240V 60Hz	276549	276584	276689	276724	276829	276864	–	–
230V 50Hz 240V 60Hz	276550	276585	276690	276725	276830	276865	290058	290093
380V 50Hz 440V 60Hz	276551	276586	276691	276726	276831	276866	–	–
400V 50Hz 440V 60Hz	276552	276587	276692	276727	276832	276867	–	–
415V 50Hz 480V 60Hz	276553	–	276693	–	276833	–	–	–
24V 50Hz/60Hz	276554	276589	276694	276729	276834	276869	290062	290097
42V 50Hz/60Hz	276555	276590	276695	276730	276835	276870	–	–
110V 50Hz/60Hz	276556	276591	276696	276731	276836	276871	–	–
220V 50Hz/60Hz	276557	276592	276697	276732	276837	276872	–	–
230V 50Hz/60Hz	276558	276593	276698	276733	276838	276873	290066	290101
Special voltages other than the already shown normal voltages ²⁾	See price list	See price list	See price list	See price list	See price list	See price list	See price list	See price list
...V 50Hz (12 – 600V)³⁾	276562	276597	276702	276737	276842	276877	290070	290105
...V 60Hz (12 – 600V)³⁾	276563	276598	276703	276738	276843	276878	290071	290106

DILM

DC

	DILM7-10 (...)	DILM7-01 (...)	DILM9-10 (...)	DILM9-01 (...)	DILM12-10 (...)	DILM12-01 (...)	DILM15-10 (...)	DILM15-01 (...)
	Article no. ¹⁾	Article no. ¹⁾	Article no. ¹⁾	Article no. ¹⁾	Article no. ¹⁾	Article no. ¹⁾	Article no. ¹⁾	Article no. ¹⁾
Standard voltages	See price list	See price list	See price list	See price list	See price list	See price list	See price list	See price list
24V DC	276565	276600	276705	276740	276845	276880	290073	290108
48V DC	276566	276601	276706	276741	276846	276881	–	–
110V DC	276568	276603	276708	276743	276848	276883	–	–
220V DC	276569	276604	276709	276744	276849	276884	–	–
Special voltages other than the already shown normal voltages ²⁾	See price list	See price list	See price list	See price list	See price list	See price list	See price list	See price list
...V DC (12-250V)³⁾	276570	276605	276710	276745	276850	276885	290078	290113

Notes

- ¹⁾ To obtain the article number for ordering, read under selected part number and actuating voltage from the table. devices with dual-voltage coils can be ordered under a single article no.
- ²⁾ With non-standard voltages the required actuating voltage from the defined range (...-...V) must be stated.
- ³⁾ Minimum order quantity 10 units

1.13

Contactors Actuating voltages

1 DILM

AC	DILM17-10 (...)	DILM17-01 (...)	DILM25-10 (...)	DILM25-01 (...)	DILM32-10 (...)	DILM32-01 (...)	DILM38-10(...)	DILM38-01(...)
	Article no. ¹⁾	Article no. ¹⁾	Article no. ¹⁾	Article no. ¹⁾	Article no. ¹⁾	Article no. ¹⁾	Article no. ¹⁾	Article no. ¹⁾
Standard voltages	See price list	See price list	See price list	See price list	See price list	See price list	See price list	See price list
24V 50Hz	276991	277023	277119	277151	277247	277279	112378	112446
240V 50Hz	276993	–	277121	–	277249	–	112420	–
42V 50Hz 48V 60Hz	277000	–	277128	–	277256	–	112424	–
110V 50Hz 120V 60Hz	277001	277033	277129	277161	277257	277289	112425	112454
190V 50Hz 220V 60Hz	277002	–	277130	–	277258	–	112426	–
220V 50Hz 240V 60Hz	277003	–	277131	–	277259	–	112427	–
230V 50Hz 240V 60Hz	277004	277036	277132	277164	277260	277292	112428	112457
380V 50Hz 440V 60Hz	277005	–	277133	–	277261	–	112429	–
400V 50Hz 440V 60Hz	277006	277038	277134	277166	277262	277294	112430	112459
415V 50Hz 480V 60Hz	277007	–	277135	–	277263	–	112431	–
24V 50Hz/60Hz	277008	277040	277136	277168	277264	277296	112432	112461
42V 50Hz/60Hz	277009	–	277137	–	277265	–	112433	–
110V 50Hz/60Hz	277010	277042	277138	277170	277266	277298	112434	112463
220V 50Hz/60Hz	277011	277043	277139	277171	277267	277299	112435	112464
230V 50Hz/60Hz	277012	277044	277140	277172	277268	277300	112436	112465
Special voltages other than the already shown normal voltages ²⁾	See price list	See price list	See price list	See price list	See price list	See price list	See price list	See price list
...V 50Hz (24 – 600V)	277016 ⁷⁾	277048 ⁷⁾	277144 ⁷⁾	277176 ⁷⁾	277272 ⁷⁾	277304 ⁸⁾	112440 ⁷⁾	112468 ⁷⁾
...V 60Hz (24 – 600V)	277017 ⁷⁾	277049 ⁷⁾	277145 ⁷⁾	277177 ⁷⁾	277273 ⁷⁾	277305 ⁸⁾	112441 ⁷⁾	112469 ⁷⁾

DILM

DC	DILM17-10(...)	DILM17-01(...)	DILM25-10(...)	DILM25-01(...)	DILM32-10(...)	DILM32-01(...)	DILM38-10(...)	DILM38-01(...)
	Article no. ¹⁾	Article no. ¹⁾	Article no. ¹⁾	Article no. ¹⁾	Article no. ¹⁾	Article no. ¹⁾	Article no. ¹⁾	Article no. ¹⁾
Standard voltages	See price list	See price list	See price list	See price list	See price list	See price list	See price list	See price list
RDC 24³⁾	277018	277050	277146	277178	277274	277306	112442	112470
RDC 60⁴⁾	277019	277051	277147	277179	277275	277307	112443	112471
RDC 130⁵⁾	277020	277052	277148	277180	277276	277308	112444	112472
RDC 240⁶⁾	277021	277053	277149	277181	277277	277309	112445	112473

Notes

- ¹⁾ To obtain the article number for ordering, read under selected part number and actuating voltage from the table. devices with dual-voltage coils can be ordered under a single article no.
- ²⁾ With non-standard voltages the required actuating voltage from the defined range (...–...V) must be stated.
- ³⁾ 24 – 27 V DC
- ⁴⁾ 48 – 60 V DC
- ⁵⁾ 110 – 130 V DC
- ⁶⁾ 200 – 240 V DC
- ⁷⁾ Minimum order quantity 10 units
- ⁸⁾ Minimum order quantity 5 units

DILM

AC

	DILM40(...)	DILM50(...)	DILM65(...)	DILM72(...)
	Article no. ¹⁾	Article no. ¹⁾	Article no. ¹⁾	Article no. ¹⁾
Standard voltages	See price list	See price list	See price list	See price list
24V 50Hz	277753	277817	277881	–
240V 50Hz	277755	277819	277883	109183
42V 50Hz 48V 60Hz	277762	277826	277890	–
110V 50Hz 120V 60Hz	277763	277827	277891	109191
190V 50Hz 220V 60Hz	277764	277828	277892	–
220V 50Hz 240V 60Hz	277765	277829	277893	–
230V 50Hz 240V 60Hz	277766	277830	277894	107670
380V 50Hz 440V 60Hz	277767	277831	277895	–
400V 50Hz 440V 60Hz	277768	277832	277896	109195
415V 50Hz 480V 60Hz	277769	277833	277897	–
24V 50Hz/60Hz	277770	277834	277898	109197
42V 50Hz/60Hz	277771	277835	277899	–
110V 50Hz/60Hz	277772	277836	277900	109199
220V 50Hz/60Hz	277773	277837	277901	109200
230V 50Hz/60Hz	277774	277838	277902	109201
Special voltages other than the already shown normal voltages ²⁾	See price list	See price list	See price list	See price list
...V 50Hz (24 – 600V)	277778 ⁸⁾	277842 ⁸⁾	277906 ⁸⁾	109205 ⁷⁾
...V 60Hz (24 – 600V)	277779 ⁸⁾	277843 ⁸⁾	277907 ⁸⁾	109206 ⁷⁾

DILM

DC

	DILM40(...)	DILM50(...)	DILM65(...)	DILM72(...)
	Article no. ¹⁾	Article no. ¹⁾	Article no. ¹⁾	Article no. ¹⁾
Standard voltages	See price list	See price list	See price list	See price list
RDC 24³⁾	277780	277844	277908	107671
RDC 60⁴⁾	277781	277845	277909	–
RDC 130⁵⁾	277782	277846	277910	–
RDC 240⁶⁾	277783	277847	277911	109209

Notes

- ¹⁾ To obtain the article number for ordering, read under selected part number and actuating voltage from the table.
- devices with dual-voltage coils can be ordered under a single article no.
- ²⁾ With non-standard voltages the required actuating voltage from the defined range (...–...V) must be stated.
- ³⁾ 24 – 27 V DC
- ⁴⁾ 48 – 60 V DC
- ⁵⁾ 110 – 130 V DC
- ⁶⁾ 200 – 240 V DC
- ⁷⁾ Minimum order quantity 10 units

1.13

Contactors Actuating voltages

1 DILM

AC	DILM80 (...)	DILM95 (...)
	Article no. ¹⁾	Article no. ¹⁾
Standard voltages	See price list	See price list
24 V 50 Hz	235904	239467
240V 50Hz	235910	239469
42V 50Hz	239394	239476
48V 60Hz		
110V 50Hz	239399	239477
120V 60Hz		
190V 50Hz	239400	239478
220V 60Hz		
220V 50Hz	239401	239479
240V 60Hz		
230V 50Hz	239402	239480
240V 60Hz		
380V 50Hz	239403	239481
440V 60Hz		
400V 50Hz	239404	239482
440V 60Hz		
415V 50Hz	239405	239483
480V 60Hz		
24V 50Hz/60Hz	239406	239484
42V 50Hz/60Hz	239407	239485
110V 50Hz/60Hz	239408	239486
220V 50Hz/60Hz	239409	239487
230V 50Hz/60Hz	239410	239488
Special voltages other than the already shown normal voltages ²⁾	See price list	list
...V 50Hz (24 – 600V)¹³⁾	239414	239504
...V 60Hz (24 – 600V)¹³⁾	239415	239509

DILM

DC	DILM80 (...)	DILM95 (...)
	Article no. ¹⁾	Article no. ¹⁾
Standard voltages	See price list	See price list
RDC 24³⁾	239416	239510
RDC 60⁴⁾	239417	239511
RDC 130⁵⁾	239418	239512
RDC 240⁶⁾	239419	239513

DILM

AC	DILM115 (...)	DILM150 (...)	DILM170 (...)	DILM185A/ 22(...)	DILM225A/ 22(...)
	Article no. ¹⁾	Article no. ¹⁾	Article no. ¹⁾	Article no. ¹⁾	Article no. ¹⁾
Standard voltages	See price list	See price list	See price list	See price list	See price list
RAC 24⁷⁾	239545	239585	107010	139534	139544
RAC 48⁸⁾	239546	239586	107011	139535	139545
RAC 120⁹⁾	239547	239587	107012	139536	139546
RAC 240¹⁰⁾	239548	239588	107013	139537	139547
RAC 440¹¹⁾	239549	239589	107014	139538	139548
RAC 500¹²⁾	239550	239590	107015	139539	139549

DILM

DC	DILM115 (...)	DILM150 (...)	DILM170 (...)	DILM185A/ 22(...)	DILM225A/ 22(...)
	Article no. ¹⁾	Article no. ¹⁾	Article no. ¹⁾	Article no. ¹⁾	Article no. ¹⁾
Standard voltages	See price list	See price list	See price list	See price list	See price list
RDC 24³⁾	239555	239591	107016	139540	139550
RDC 60⁴⁾	239560	239592	107017	139541	139551
RDC 130⁵⁾	239567	239593	107018	139542	139552
RDC 240⁶⁾	239572	239594	107019	139543	139553

Notes

- ¹⁾ The article no. results from combining the part no. and the actuating voltage.
Devices with dual-voltage coils must be ordered under a single article no.
- ²⁾ With non-standard voltages the required actuating voltage from the defined range (...-...V) must be stated.
- ³⁾ 24 - 27 V DC
- ⁴⁾ 48 – 60 V DC
- ⁵⁾ 110 - 130 V DC
- ⁶⁾ 200 - 240 V DC
- ⁷⁾ 24 V 50/60 Hz
- ⁸⁾ 42 – 48 V 50/60 Hz
- ⁹⁾ 100 – 120 V 50/60 Hz
- ¹⁰⁾ 190 – 240 V 50/60 Hz
- ¹¹⁾ 380 – 440 V 50/60 Hz
- ¹²⁾ 480 – 500 V 50/60 Hz
- ¹³⁾ Minimum order quantity 5 units

DILM

AC	DILMC7-10 (...)	DILMC7-01 (...)	DILMC9-10 (...)	DILMC9-01 (...)	DILMC12-10 (...)	DILMC12-01 (...)	DILMC15-10 (...)	DILMC15-01 (...)
	Article no. ¹⁾	Article no. ¹⁾	Article no. ¹⁾	Article no. ¹⁾	Article no. ¹⁾	Article no. ¹⁾	Article no. ¹⁾	Article no. ¹⁾
Standard voltages	See price list	See price list	See price list	See price list	See price list	See price list	See price list	See price list
24 V 50 Hz	277379	277411	277443	277475	277507	277539	293938	293933
110V 50Hz 120V 60Hz	277386	277418	277450	277482	277514	277546	293908	293943
230V 50Hz 240V 60Hz	277389	277421	277453	277485	277517	277549	293911	293946
24V 50Hz/60Hz	277393	277425	277457	277489	277521	277553	293915	293950
230V 50Hz/60Hz	277397	277429	277461	277493	277525	277557	293919	293954
Special voltages other than the already shown normal voltages ²⁾	See price list	See price list	See price list	See price list	See price list	See price list	See price list	See price list
...V 50Hz (12 – 600V)⁶⁾	277401	277433	277465	277497	277529	277561	293923	293958
...V 60Hz (12 – 600V)⁶⁾	277402	277434	277466	277498	277530	277562	293924	293959

DILM

DC	DILMC7-10 (...)	DILMC7-01 (...)	DILMC9-10 (...)	DILMC9-01 (...)	DILMC12-10 (...)	DILMC12-01 (...)	DILMC15-10 (...)	DILMC15-01 (...)
	Article no. ¹⁾	Article no. ¹⁾	Article no. ¹⁾	Article no. ¹⁾	Article no. ¹⁾	Article no. ¹⁾	Article no. ¹⁾	Article no. ¹⁾
Standard voltages	See price list	See price list	See price list	See price list	See price list	See price list	See price list	See price list
24V DC	277404	277436	277468	277500	277532	277564	293926	293961
110V DC	277407	277439	277471	277503	277535	277567	293929	293964
220V DC	277408	277440	277472	277504	277536	277568	293930	293965
Special voltages other than the already shown normal voltages ²⁾	See price list	See price list	See price list	See price list	See price list	See price list	See price list	See price list
...VDC (12 – 250V)⁶⁾	277409	277441	277473	277505	277537	277569	293931	293966

DILM

AC	DILMC17-10 (...)	DILMC17-01 (...)	DILMC25-10 (...)	DILMC25-01 (...)	DILMC32-10 (...)	DILMC32-01 (...)
	Article no. ¹⁾	Article no. ¹⁾	Article no. ¹⁾	Article no. ¹⁾	Article no. ¹⁾	Article no. ¹⁾
Standard voltages	See price list	See price list	See price list	See price list	See price list	See price list
24 V 50 Hz	277570	277600	277630	277660	277690	277720
110V 50Hz 120V 60Hz	277578	277608	277638	277668	277698	277728
230V 50Hz 240V 60Hz	277581	277611	277641	277671	277701	277731
24V 50Hz/60Hz	277585	277615	277645	277675	277705	277735
220V 50Hz/60Hz	277588	277618	277648	277678	277708	277738
230V 50Hz/60Hz	277589	277619	277649	277679	277709	277739
Special voltages other than the already shown normal voltages ²⁾	See price list	See price list	See price list	See price list	See price list	See price list
...V 50Hz (24 – 600V)⁶⁾	277593	277623	277653	277683	277713	277743
...V 60Hz (24 – 600V)⁶⁾	277594	277624	277654	277684	277714	277744

DILM

DC	DILMC17-10 (...)	DILMC17-01 (...)	DILMC25-10 (...)	DILMC25-01 (...)	DILMC32-10 (...)	DILMC32-01 (...)
	Article no. ¹⁾	Article no. ¹⁾	Article no. ¹⁾	Article no. ¹⁾	Article no. ¹⁾	Article no. ¹⁾
Standard voltages	See price list	See price list	See price list	See price list	See price list	See price list
RDC 24³⁾	277595	277625	277655	277685	277715	277745
RDC 130⁴⁾	277597	277627	277657	277687	277717	277747
RDC 240⁵⁾	277598	277628	277658	277688	277718	277748

Notes

- ¹⁾ The article no. results from combining the part no. and the actuating voltage.
Devices with dual-voltage coils must be ordered under a single article no.
- ²⁾ With non-standard voltages the required actuating voltage from the defined range (...-...V) must be stated.
- ³⁾ 24 - 27 V DC
- ⁴⁾ 110 - 130 V DC
- ⁵⁾ 200 - 240 V DC
- ⁶⁾ Minimum order quantity 10 units

1.13

Contactors Actuating voltages

1 DILMP20

AC	DILMP20 (...)	AC	DILMP20 (...)	AC	DILMP20 (...)
	Article no. ¹⁾		Article no. ¹⁾		Article no. ¹⁾
Standard voltages	See price list	Standard voltages	See price list	Non-standard voltages ²⁾	See price list
240V 50Hz	–	RAC 24⁴⁾	–	... V 50Hz (12 – 600V)³⁾	276982
110V 50Hz	276967	RAC 120⁵⁾	–	... V 60Hz (12 – 600V)³⁾	276983
120V 60Hz		RAC 240⁶⁾	–		
230 V 50Hz	276970				
240V 60Hz					
24V 50/60Hz	276974				
230V 50/60Hz	276978				

DILMP20

DC	DILMP20 (...)	DC	DILMP20 (...)
	Article no. ¹⁾		Article no. ¹⁾
Standard voltages	See price list	Non-standard voltages ²⁾	See price list
24V DC	276985	... V DC (12 – 250V)³⁾	276990
RDC 24⁷⁾	–		

Notes

- ¹⁾ The article number is a combination of part no. and actuating voltage
- ²⁾ For non-standard voltages, state the actuating voltage selected from the range (... – ... V) shown.
- ³⁾ Minimum order quantity: 10 units
- ⁴⁾ 24 V 50/60 Hz
- ⁵⁾ 100 – 120 V 50/60 Hz
- ⁶⁾ 190 – 240 V 50/60 Hz
- ⁷⁾ 24 – 27 V DC

DILM...XSP...

AC	DILM32-XSP (...)	DILM65-XSP (...)	DILM95- XSP
	Article no. ¹⁾	Article no. ¹⁾	Article no. ¹⁾
Standard voltages	See price list	See price list	See price list
24V 50Hz	281130	281160	229984
240V 50Hz	281132	281162	229986
24V 60Hz	281134	281164	229988
115V 60Hz	281136	281166	229990
42V 50Hz	281137	281167	229994
48V 60Hz			
110V 50Hz	281138	281168	230058
120V 60Hz			
190V 50Hz	281139	281169	230059
220V 60Hz			
220V 50Hz	281140	281170	230061
240V 60Hz			
230V 50Hz	281141	281171	230062
240V 60Hz			
380V 50Hz	281142	281172	230063
440V 60Hz			
400V 50Hz	281143	281173	230064
440V 60Hz			
415V 50Hz	281144	281174	230065
480V 60Hz			
24V 50Hz/60Hz	281145	281175	230066
42V 50Hz/60Hz	281146	281176	230067
110V 50Hz/60Hz	281147	281177	230068
220V 50Hz/60Hz	281148	281178	230073
230V 50Hz/60Hz	281149	281179	230074
Special voltages other than the already shown normal-voltages ²⁾	See price list	See price list	See price list
...V 50Hz (24 – 600V)	281153 ¹³⁾	281183 ¹⁴⁾	230078 ¹⁴⁾
...V 60Hz (24 – 600V)	281154 ¹³⁾	281184 ¹⁴⁾	230079 ¹⁴⁾

DILM...XSP...

DC	DILM32-XSP (...)	DILM65-XSP (...)	DILM95- XSP
	Article no. ¹⁾	Article no. ¹⁾	Article no. ¹⁾
Standard voltages	See price list	See price list	See price list
RDC 24³⁾	281155	281185	230080
RDC 60⁴⁾	281156	281186	230081
RDC 130⁵⁾	281157	281187	230082
RDC 240⁶⁾	281158	281188	230107

DILM...XSP...

AC	DILM150-XSP (...)	DILM225A-XSP (...)
	Article no. ¹⁾	Article no. ¹⁾
Standard voltages	See price list	See price list
RAC 24⁷⁾	230109	139562
RAC 48⁸⁾	230110	139563
RAC 120⁹⁾	230111	139564
RAC 240¹⁰⁾	230112	139565
RAC 440¹¹⁾	230113	139566
RAC 500¹²⁾	230114	139567

DILM...XSP...

DC	DILM150-XSP (...)	DILM225A-XSP (...)
	Article no. ¹⁾	Article no. ¹⁾
Standard voltages	See price list	See price list
RDC 24³⁾	230115	139568
RDC 60⁴⁾	230116	139569
RDC 130⁵⁾	230117	139570
RDC 240⁶⁾	230122	139571

Notes

- 1) To obtain the article number for ordering, read under selected part number and actuating voltage from the table.
Devices with dual-voltage coils are to be ordered under a single article number.
- 2) With non-standard voltages the required actuating voltage from the defined range (...–...V) must be stated.
- 3) 24 – 27 V DC
- 4) 48 – 60 V DC
- 5) 110 – 130 V DC
- 6) 200 – 240 V DC
- 7) 24 V 50/60 Hz
- 8) 42 – 48 V 50/60 Hz
- 9) 100 – 120 V 50/60 Hz
- 10) 190 – 240 V 50/60 Hz
- 11) 380 – 440 V 50/60 Hz
- 12) 480 – 500 V 50/60 Hz
- 13) Minimum order quantity 10 units
- 14) Minimum order quantity 5 units

1.13

Contactor for capacitors, contactor

Actuating voltages

1 DILK, DILMF

AC	DILK12-11 (...)	DILK20-11 (...)	DILK25-11 (...)	DILK33-10 (...)	DILK50-10 (...)
	Article no. ¹⁾	Article no. ¹⁾	Article no. ¹⁾	Article no. ¹⁾	Article no. ¹⁾
Standard voltages	See price list	See price list	See price list	See price list	See price list
110V 50Hz, 120V 60Hz	293985	294007	294029	294051	294073
190V 50Hz, 220V 60Hz	293986	294008	294030	294052	294074
230V 50Hz, 240V 60Hz	293988	294010	294032	294054	294076
400V 50Hz, 440V 60Hz	293990	294012	294034	294056	294078
Special voltages other than the already shown normal voltages ²⁾	See price list	See price list	See price list		
...V 50Hz (24 – 600V) ³⁾	293997	294019	294041	–	–
...V 60Hz (24 – 600V) ³⁾	293998	294020	294042	–	–

Notes

¹⁾ The article no. results from combining the part no. and the actuating voltage. Devices with dual-voltage coils must be ordered under a single article no.

²⁾ With non-standard voltages the required actuating voltage from the defined range (...–...V) must be stated.

³⁾ Minimum order quantity 10 units

DILM

Complete comfort devices

	DILM250 /22(...)	DILM300A /22(...)	DILM400 /22(...)	DILM500 /22(...)	DILM580 /22(...)	DILM650 /22(...)	DILM750 /22(...)	DILM820 /22(...)	DILM1000 /22(...)
Voltage variants	Article no. ¹⁾ See price list	Article no. ¹⁾ See price list	Article no. ¹⁾ See price list	Article no. ¹⁾ See price list	Article no. ¹⁾ See price list	Article no. ¹⁾ See price list	Article no. ¹⁾ See price list	Article no. ¹⁾ See price list	Article no. ¹⁾ See price list
RDC 48²⁾	208199	139554	208207	208211	–	–	–	–	–
RA 110³⁾	208200	139555	208208	208212	208215	208218	208221	208224	–
RA 250⁴⁾	208201	139556	208209	208213	208216	208219	208222	208225	267214
RAC 500^{5) 6)}	208202	139557	208210	208214	208217	208220	208223	208226	–

DILM

Complete units
Standard

	DILM250 -S/22(...)	DILM300A -S/22(...)	DILM400 -S/22(...)	DILM500 -S/22(...)
Voltage variants	Article no. ¹⁾ See price list	Article no. ¹⁾ See price list	Article no. ¹⁾ See price list	Article no. ¹⁾ See price list
110-120V 50/60Hz	274189	139558	274195	274198
220-240V 50/60Hz	274190	139559	274196	274199

DILM

Electronic module, incl. coil, for
comfort model

	DILM250-XSP/E(...)	DILM500-XSP/E(...)	DILM1000-XSP/E(...)
Voltage variants	Article no. ¹⁾ See price list	Article no. ¹⁾ See price list	Article no. ¹⁾ See price list
RDC 48²⁾	208250	208254	–
RA 110³⁾	208251	208255	289146
RA 250⁴⁾	208252	208256	289145
RAC 500^{5) 6)}	208253	208257	289147

DILM

Electronic module, incl. coil, for
standard model

	DILM250-S-XSP/E(...)	DILM500-S-XSP/E(...)
Voltage variants	Article no. ¹⁾ See price list	Article no. ¹⁾ See price list
110-120V 50/60Hz	274201	274204
220-240V 50/60Hz	274202	274205

Notes

- ¹⁾ The article no. results from combining the part no. and the voltage variant.
- ²⁾ 24 – 48 V DC
- ³⁾ 48 – 110 V 40 – 60 Hz/48 – 110 V DC
- ⁴⁾ 110 – 250 V 40 – 60 Hz/110 – 250 V DC
- ⁵⁾ 250 – 500 V 40 – 60 Hz
- ⁶⁾ DC on request

1.14

Contactors Contact travel diagrams

1 Engineering

DILM, DILA, DILE, DILH

The diagrams show the closing and opening travel of the contacts at no load.

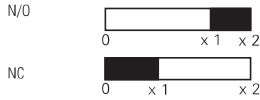

		x1	x2
DILE AC	N/O	1.9	2.8
	NC	0.95	2.8
...DILE	N/O	1.9	2.8
	NC	0.9	2.8
...DDILE	NO early-make	1.06	2.9
	Late-break N/C contact	1.86	2.9
	N/O	1.9	2.8
	NC	0.9	2.8
DILE DC	N/O	1.9	2.85
	NC	0.95	2.85
DILE...	N/O	1.9	2.8
	NC	0.9	2.8
...DDILE	NO early-make	1.06	2.9
	Late-break N/C contact	1.86	2.9
	N/O	1.9	2.8
	NC	0.9	2.8
DILA-AC	N/O	3.3	4.5
	NC	1.0	4.5
DILA-XHI	N/O	3.2	4.5
	NC	1.6	4.5
DILA-XHIV	NO early-make	2.0	4.5
	Late-break N/C contact	2.8	4.5
	N/O	3.2	4.5
	NC	1.6	4.5
DILA-DC	N/O	2.1	2.9
	NC	0.7	2.9
DILA-XHI	N/O	2.3	2.9
	NC	0.7	2.9
DILA-XHIV	NO early-make	1.1	2.9
	Late-break N/C contact	1.9	2.9
	N/O	2.3	2.9
	NC	0.7	2.9
DILM7/9 AC	N/O	3.3	4.5
	NC	1.0	4.5
DILM32-XHI, DILA-XHI	N/O	3.2	4.5
	NC	1.6	4.5
DILA-XHIV	NO early-make	2.0	4.5
	Late-break N/C contact	2.8	4.5
	N/O	3.2	4.5
	NC	1.6	4.5
DILM7/9 DC	N/O	2.1	2.9
	NC	0.7	2.9
DILM32-XHI, DILA-XHI	N/O	2.3	2.9
	NC	0.7	2.9
DILA-XHIV	NO early-make	1.1	2.9
	Late-break N/C contact	1.9	2.9
	N/O	2.3	2.9
	NC	0.7	2.9
DILM12/15/P20 AC	N/O	3.3	4.5
	NC	1.0	4.5
DILM32-XHI, DILA-XHI	N/O	3.2	4.5
	NC	1.6	4.5
DILA-XHIV	NO early-make	2.0	4.5
	Late-break N/C contact	2.8	4.5
	N/O	3.2	4.5
	NC	1.6	4.5
DILM12/15/P20 DC	N/O	3.3	4.4
	NC	1.0	4.4
DILM32-XHI, DILA-XHI	N/O	3.2	4.4
	NC	1.6	4.4

DILM, DILA, DILE, DILH

The diagrams show the closing and opening travel of the contacts at no load.

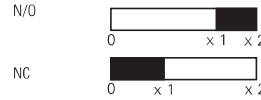

		x1	x2
DILA-XHIV	NO early-make	2.0	4.4
	Late-break N/C contact	2.8	4.4
	N/O	3.2	4.4
	NC	1.6	4.4
DILM17/25/32/P32/P45	N/O	4.0	6.0
	Auxiliary N/C	1.8	6.0
	Auxiliary N/O	3.2	6.0
DILM32-XHI, DILA-XHI	N/O	3.2	6.0
	NC	1.6	6.0
DILA-XHIV	NO early-make	2.0	6.0
	Late-break N/C contact	2.8	6.0
	N/O	3.2	6.0
	NC	1.6	6.0
DILM40/50/65/P63/P80	N/O	5.1	7.5
DILM150-XHI	N/O	5.7	7.5
	NC	3.9	7.5
DILM150-XHIV	NO early-make	3.8	7.5
	Late-break N/C contact	5.4	7.5
	N/O	5.7	7.5
	NC	3.9	7.5
DILM1000-XHI	N/O	5.5	7.5
	NC	3.6	7.5
DILM1000-XHIV	NO early-make	4.1	7.5
	Late-break N/C contact	5.0	7.5
DILM80/95/115/150/170/P125/P160/P200	N/O	8.0	11
DILM150-XHI	N/O	9.2	11
	NC	7.4	11
DILM150-XHIV	NO early-make	7.3	11
	Late-break N/C contact	8.9	11
	N/O	9.2	11
	NC	7.4	11
DILM1000-XHI	N/O	9.0	11
	NC	7.1	11
DILM1000-XHIV	NO early-make	7.6	11
	Late-break N/C contact	8.5	11
DILM185A/225A	N/O	10.0	13.0
DILM1000-XHI	N/O	10.0	13.0
	NC	8.1	13.0
DILM1000-XHIV	NO early-make	8.4	13.0
	Late-break N/C contact	9.5	13.0
DILM250/300A	N/O	10.1	13.1
DILM820-XHI	N/O	10.3	13.1
	NC	8.4	13.1
DILM820-XHIV	NO early-make	8.7	13.1
	Late-break N/C contact	9.8	13.1
DILM400/500/570	N/O	8.9	13.1
DILM820-XHI	N/O	10.3	13.1
	NC	8.4	13.1
DILM820-XHIV	NO early-make	8.7	13.1
	Late-break N/C contact	9.8	13.1
DILM580/650/750/820	N/O	2.0	4.1
DILM820-XHI	N/O	7.4	10.5
	NC	5.5	10.5
DILM820-XHIV	NO early-make	6.0	10.5
	Late-break N/C contact	6.8	10.5
DILM1000/1600, DILH1400/2000/2200/2600	N/O	2.0	4.1
DILM820-XHI	N/O	7.4	10.5
	NC	5.5	10.5
DILM820-XHIV	NO early-make	6.0	10.5
	Late-break N/C contact	6.8	10.5

DILE, DILM, SDAINL, DIUL

Components

Contactor selection

Part no.	With top mounting auxiliary contacts	With side mounting auxiliary contacts	With overload relay	With parallel connector	Insulated enclosures
DILE...(-G)(-C)	–	–	–	–	CI-K1-95-TS
DILE...(-G)(-C)	●	–	–	–	CI-K2-145-TS
DILE...(-G)	●	–	●	–	CI-K2-145-AD
DILE...(-G)	–	–	–	●	CI-K2-100-TS
DILE...(-G)	●	–	–	●	CI-K2-145-TS
DILM7 to DILM15	●	–	–	–	CI-K2-145-TS
DILM7 to DILM15	●	–	●	–	CI-K3-160-TS
DILM17 to DILM32	–	–	–	–	CI-K2-145-TS
DILM17 to DILM32	●	–	●	–	CI23E-150
DILM40 to DILM65	–	●	–	–	CI-K3-160-TS
DILM40 to DILM65	●	●	●	–	CI43E-150
DILM80 to DILM170	●	●	–	–	CI43E-200
DILM80 to DILM170	●	●	●	–	CI44E-200
DILM185A	–	●	–	–	CI48-250
DILM225A	–	●	–	–	CI48-250
DILM250	–	●	–	–	CI48-250
DILM300A	–	●	–	–	CI48-250
DILM400	–	●	–	–	CI48-250
DILM500	–	●	–	–	CI48-250
DILM580	–	●	–	–	CI48-250
DILM650	–	●	–	–	CI48-250
DILM750	–	●	–	–	CI48-250
DILM820	–	●	–	–	CI48-250
DIULE...	●	–	–	–	CI-K3-125-TS
DIULE...	●	–	●	–	CI-K3-125-TS
DIULM7 to DIULM12	●	–	–	–	CI-K4-160-TS
DIULM17 to DIULM32	●	–	–	–	CI23E-150
DIULM40 to DIULM65	●	–	–	–	CI43E-200
SDAINLEM...	●	–	–	–	CI-K5-125-TS CI-K5-125-M
SDAINLM12 to SDAINLM22	●	–	–	–	CI-K5-160-TS
SDAINLM30 to SDAINLM65	●	–	–	–	CI23E-150
SDAINLM70 to SDAINLM115	●	–	–	–	CI43E-200

Notes

CI-K small enclosure	→ Chapter 20	Insulated PE, N or PEN terminal for enclosure CI-K	→ Chapter 20
Terminal for CI-K enclosure	→ Chapter 20		
CI enclosure	→ Chapter 20		

1.14

Contactors

UL/CSA-approved rating data

1 for North America

DILE, DILA, DILM

Rating data for approved types



Maximum alternating current-motor rating

Single-phase

3-phase

115 V 120 V HP	230 V 240 V HP	200 V 208 V HP	230 V 240 V HP	460 V 480 V HP	575 V 600 V HP
----------------------	----------------------	----------------------	----------------------	----------------------	----------------------

GENERAL USE

Maximum motor-rated current
I_{th}
Open/enclosed

A

Contactors

NEMA size

						A	Part no.	NEMA size
1/2	1 1/2	2	3	5	5	15/13.5	DILEM(4)	00
1/4	1	1 1/2	2	3	5	20	DILM7-...(…)	00
1/2	1 1/2	3	3	5	7 1/2	20	DILM9-...(…)	00
1	2	3	3	10	10	20	DILM12-...(…)	0
1	3		5	10	10	20	DILM15-...(…)	0
2	3	5	7 1/2	10	15	35	DILM17-...(…)	0
2	5	7 1/2	7 1/2	15	20	35	DILM25-...(…)	1
3	5	10	10	20	25	40	DILM32-...(…), DILM38-...(…)	1
3	7 1/2	10	15	30	40	55	DILM40(…)	2
3	10	15	20	40	50	65	DILM50(…)	2
5	15	20	25	40	60	80	DILM65(…), DILM70(…)	2
7 1/2	15	25	30	60	75	125	DILM80(…)	3
7 1/2	15	25	40	75	100	125	DILM95(…)	3
10	25	40	50	100	125	160	DILM115(…)	4
15	30	40	60	125	125	160	DILM150(…), DILM170(…)	4
–	–	50	60	125	150	225	DILM185(…)	4
–	–	60	75	150	200	250	DILM225(…)	4
–	–	75	100	200	250	350	DILM250(…)	5
–	–	100	125	250	300	350	DILM300(…)	5
–	–	125	150	300	400	450	DILM400(…)	5
–	–	150	200	400	500	550	DILM500(…)	6
–	–	200	200	400	600	630	DILM580(…)	6
–	–	200	250	500	600	700	DILM650(…)	6
–	–	250	300	600	700	800	DILM750(…)	6
–	–	290	350	700	860	850	DILM820(…)	6
–	–	350	400	800	1000	1000	DILM1000(…)	7
–	–	560	640	1200	1300	1600	DILM1600(…)	8

Further approvals → 81

- Elevator control
- Refrigeration control
- Resistance air heating
- Incandescent lamps
- Electrical discharge lamps
- Capacitive switching

DILE, DILA, DILM

Approved rating data

UL -File No. E29184

for auxiliary contacts



Pilot Duty

General Use

Part no.	Pilot Duty		General Use			
	AC	DC	AC V	A	DC V	A
DIL(E)EM-10(-01) DILER-40(31)(22) ...(D)DILE	A600	P300	600	10	250	0.5
DILM7-10(-01) To DILM32-10(-01) DILA...	A600	P300	600	15	250	1
DILA-XHI... DILM32-XHI...	A600	P300	600	15	250	1
DILM...-XHI11-SI DILM...-XHI11-SA DILM...-XHI11V-SI	A600	P600	600	10	–	–

for North America

DILM, DILMP, DILK

Special purpose rating



	DIL	M7	M9	M12	M15	M17	M25 MP32 MP45	M32	M40 MP63	M50 MP80	M65 M72	M80 MP125	M95 MP160	M115	M150 M170 MP200
Electrical discharge lamps (ballast)															
480V 60Hz 3phase, 277V 60Hz 1phase	A	12	18	20	20	27	35	40	63	79	88	85	100	136	160
600V 60Hz 3phase, 347V 60Hz 1phase	A	12	18	20	20	27	35	40	63	79	88	85	100	136	160
Incandescent lamps (Tungsten)															
480V 60Hz 3phase, 277V 60Hz 1phase	A	8	11	14	14	23	32	40	55	74	88	85	100	136	160
600V 60Hz 3phase, 347V 60Hz 1phase	A	8	11	14	14	23	32	40	55	74	88	85	100	136	160
Resistance air heating															
480V60Hz 3phase, 277V60Hz 1phase	A	12	18	20	20	27	35	40	63	79	88	94	110	136	160
600V60Hz 3phase, 347V60Hz 1phase	A	12	18	20	20	27	35	40	63	79	88	94	110	136	160
Refrigeration control (CSA only)															
LRA 480V 60Hz 3phase	A	60	60	60	60	240	240	240	270	270	270	540	540	540	540
LRA 600V 60Hz 3phase	A	60	60	60	60	180	180	180	270	270	270	420	420	540	540
480V 60Hz 3phase	A	6	7.5	10	10	23	32	40	26	36	45	63	70	84	90
600V 60Hz 3phase	A	6	7.5	10	10	17	24	30	26	36	45	63	70	84	90
Elevator control															
200V 60Hz 3phase	HP (A)	¾ (3.7)	2 (7.8)	2 (7.8)	2 (7.8)	3 (11)	3 (11)	7½ (25.3)	7½ (25.3)	10 (32.2)	10 (32.2)	20 (62.1)	20 (62.1)	30 (92)	30 (92)
240V 60Hz 3phase	HP (A)	1½ (6.0)	2 (6.8)	2 (6.8)	3 (9.6)	3 (9.6)	5 (15.2)	7½ (22)	10 (28)	15 (42)	15 (42)	25 (68)	30 (80)	40 (104)	40 (104)
480V 60Hz 3phase	HP (A)	2 (3.4)	3 (4.8)	7½ (11)	7½ (11)	7½ (11)	10 (14)	20 (27)	25 (34)	30 (40)	30 (40)	50 (65)	60 (77)	75 (96)	75 (96)
600V 60Hz 3phase	HP (A)	3 (3.9)	5 (6.1)	7½ (9.6)	7½ (9.6)	10 (11)	15 (17)	20 (22)	30 (32)	40 (41)	40 (41)	60 (62)	75 (77)	100 (99)	100 (99)

DILM, DILMP, DILK

Special purpose rating



	DIL	K12	K20	K25	K33	K50
Capacitor Switching						
240V 60Hz 3phase	A	18	28	36	48	72
480V 60Hz 3phase	A	18	28	36	48	72
600V 60Hz 3phase	A	14.4	28	38.4	48	72
240V 60Hz 3phase	kvar	7.5	12	15	20	30
480V 60Hz 3phase	kvar	15	20	30	40	60
600V 60Hz 3phase	kvar	15	30	40	50	75

1.14

Contactors

UL/CSA Short circuit current rating

1 for North America

DILM

Short circuit current rating (SCCR)



Contactor	Basic Rating			480 V High Fault				600 V High Fault			
	kA	Max. fuse	Max. CB	kA	Max. fuse	kA	Max. CB	kA	Max. fuse	kA	Max. CB
		A	A		A		A		A		A
DILM7-...(…)	5	45	60	100	20 Class J	-	Fuse only	30	25	-	Fuse only
DILM9-...(…)	5	45	60	100	20 Class J	-	Fuse only	30	25	-	Fuse only
DILM12-...(…)	5	45	60	100	20 Class J	-	Fuse only	30	25	-	Fuse only
DILM15-...(…)	5	45	60		20 Class J	-	Fuse only	30	25	-	Fuse only
DILM17-...(…)	5	125	125	100	70 Class J	10	50	10	125	10	50
DILM25-...(…)	5	125	125	100	100 Class J	10	50	10	125	10	50
DILM32-...(…)	5	125	125	100	125 Class J	10	50	10	125	10	50
DILM38-...(…)	5	125	125	100	125 Class J	10	50	10	125	10	50
DILM40(…)	10	250	250	100	150 Class J	65	100	30	250	30	250
DILM50(…)	10	250	250	100	150 Class J	65	100	30	250	30	250
DILM65(…)	10	250	250	100	150 Class J	65	100	30	250	30	250
DILM72(…)	10	250	250	100	150 Class J	65	100	30	250	30	250
DILM80(…)	10	600	600	100	300 Class J	65	250	30	300	30	350
DILM95(…)	10	600	600	100	300 Class J	65	250	30	300	30	350
DILM115(…)	10	600	600	100	300 Class J	65	250	30	300	30	350
DILM150(…)	10	600	600	100	300 Class J	65	250	30	300	30	350
DILM170(…)	10	600	600	100	300 Class J	65	250	30	300	30	350
DILM185(…)	18	700	600	-	CB only	65	250	-	-	-	-
DILM225(…)	18	700	600	-	CB only	65	250	-	-	-	-
DILM250(…)	18	700	600	-	CB only	65	250	-	-	-	-
DILM300(…)	30	800	600	-	CB only	42	600	30	800	30	600
DILM400(…)	30	800	600	-	CB only	42	600	30	800	30	600
DILM500(…)	30	800	600	-	CB only	42	600	30	800	30	600
DILM570(…)	30	800	600	-	CB only	42	600	30	800	30	600
DILM580(…)	30	2000	1200	85	2000	85	1200	85	2000	85	1200
DILM650(…)	30	2000	1200	85	2000	85	1200	85	2000	85	1200
DILM750(…)	42	2000	1200	85	2000	85	1200	85	2000	85	1200
DILM820(…)	42	2000	1200	85	2000	85	1200	85	2000	85	1200
DILM1000(…)	85	2000	1200	85	2000	85	1200	85	2000	85	1200
DILM1600(…)	85	2000	-	85	2000	-	-	85	2000	85	-

1.14

Contactors

Contactors for resistive load

1 DILM, DILEM

Rating data

Single-phase rating AC-1

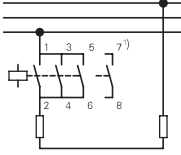

Three-phase rating AC-1

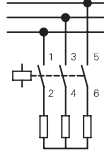

Three-phase rating AC-1

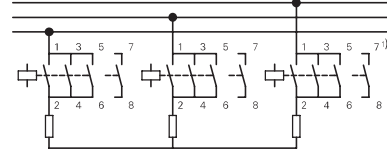

Voltage in V			Max. upstream fuse gG/gL	Rated operational current $I_e = I_{th}$ or I_{the}	Voltage in V			Max. upstream fuse gG/gL	Rated operational current $I_e = I_{th}$ or I_{the}	Voltage in V			Max. upstream fuse gG/gL	Rated operational current $I_e = I_{th}$ or I_{the}
220	380	660			220	380	660			220	380	660		
kW	kW	kW	A	A	kW	kW	kW	A	A	kW	kW	kW	A	A

Open version

10	18	31	50	50	7	13	20	20	20	18	31	54	50	50
10	18	31	50	50	7	13	20	20	20	18	31	54	50	50
12	21	37	63	60	–	–	–	–	–	21	37	65	63	60
10	18	31	–	50	7	13	22	–	20	18	31	54	–	50
13	22	38	–	60	–	–	–	–	–	22	38	65	–	60
18	32	55	–	88	13	22	38	–	35	32	55	95	–	88
21	36	63	–	100	14	25	43	–	40	36	63	109	–	100
26	45	78	–	125	18	31	54	–	50	45	78	136	–	125
34	59	102	–	163	24	41	71	–	65	59	102	176	–	163
42	72	125	–	200	29	50	87	–	80	72	125	217	–	200
47	81	141	–	225	33	56	98	–	90	81	141	244	–	225
57	99	172	–	275	40	69	119	–	110	100	172	299	–	275
68	117	204	–	325	47	81	141	–	130	118	203	353	–	325
84	144	251	–	400	58	100	174	–	160	145	250	434	–	400
101	175	317	–	460	70	120	220	–	185	175	302	549	–	460
144	248	431	800	688	100	172	299	315	275	262	453	786	–	688
165	284	494	800	788	114	197	342	315	315	300	519	900	–	788
172	297	516	1000	825	120	206	357	400	330	333	576	1000	–	875
183	316	548	1000	875	126	219	380	400	350	381	658	1143	–	1000
261	451	784	1250	1250	181	313	543	500	500	476	825	1429	–	1250
366	632	1097	–	1750	253	438	760	800	700	667	1152	2000	–	1750
418	722	1254	–	2000	290	500	869	800	800	762	1316	2286	–	2000
444	767	1332	–	2125	308	531	923	1000	850	810	1400	2429	–	2125
470	812	1411	–	2250	326	563	977	1000	900	857	1480	2572	–	2250
523	903	1568	–	2500	362	625	1086	1000	1000	953	1646	2858	–	2500
732	1264	2195	–	3500	507	875	1520	–	1400	1334	2300	4000	–	3500
1045	1805	3135	–	5000	724	1251	2172	–	2000	1905	3290	5716	–	5000
1150	1985	3449	–	5500	796	1376	2389	–	2200	2095	3619	6288	–	5500
1358	2346	4075	–	6500	941	1626	2827	–	2600	2476	4277	7430	–	6500

Notes

¹⁾ Contact 7 – 8 only with DILEM4(-G), DILMP20...

DILM, DILEM

Part no.	Ordering data	Required accessories:	Notes
		Paralleling links	

AC operated	Page	Part no.	Accessories	Page
DILEM-10(...)	→ 4	P1DILEM		
DILEM-01(...)	→ 4	P1DILEM		
DILEM4(...)	→ 4	P1DILEM		
DILM7-...(...)	→ 18	DILM12-XP1	Auxiliary contact modules	→ 6
DILMP20(...)	→ 34	DILM12-XP1	Set of paralleling links	→ 36
DILM17-...(...)	→ 18	DILM32-XP1	Enclosure	→ 53
DILM25-...(...)	→ 18	DILM32-XP1	Accessories	→ 63
DILM40(...)	→ 20	DILM65-XP1		→ 52
DILM50(...)	→ 20	DILM65-XP1		
DILM65(...)	→ 20	DILM65-XP1		
DILM80(...)	→ 20	DILM150-XP1		
DILM95(...)	→ 20	DILM150-XP1		
DILM115(...)	→ 20	DILM150-XP1		
DILM150(...)	→ 20	DILM150-XP1		
DILM170(...)	→ 20	DILM150-KP1		
DILM185A(...)	→ 30	DILM185-XP1		
DILM225A(...)	→ 30	DILM185-XP1		
DILM250(...)	→ 30	-		
DILM300A(...)	→ 30	-		
DILM400(...)	→ 30	-		
DILM500(...)	→ 30	-		
DILM580(...)	→ 30	-		
DILM650(...)	→ 30	-		
DILM750(...)	→ 30	-		
DILM820(...)	→ 30	-		
DILH1400(...)	→ 32	-		
DILH2000(...)	→ 32	-		
DILH2200(...)	→ 32	-		
DILH2600(...)	→ 32	-		

1.14

Mini contactor relays, contactor relays

Electrical lifespan

1 DILA (AC-15)

Component lifespan (operations)
 I_e = Rated operational current

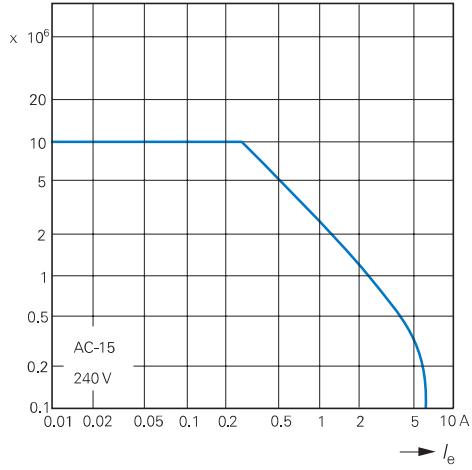

DILA DC¹⁾

Component lifespan (operations)
 I_e = Rated operational current

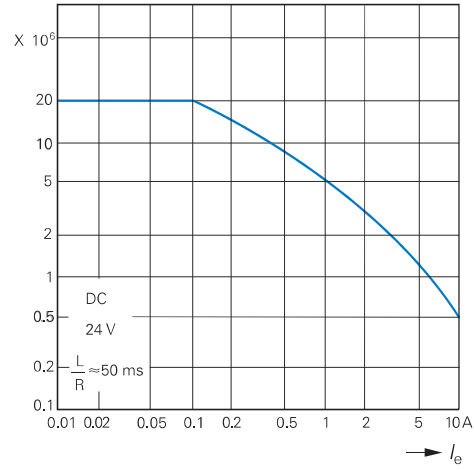

¹⁾ Three contacts in series

DILER (AC-15)

Component lifespan (operations)
 I_e = Rated operational current

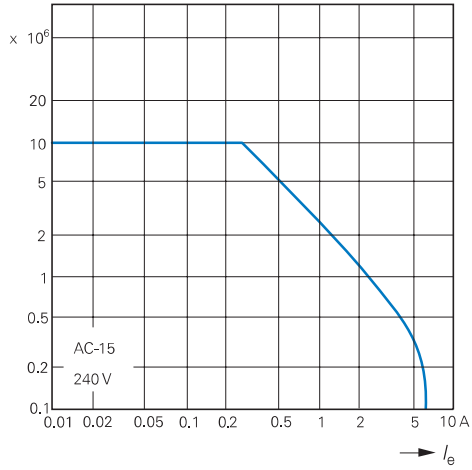

Normal switching duty

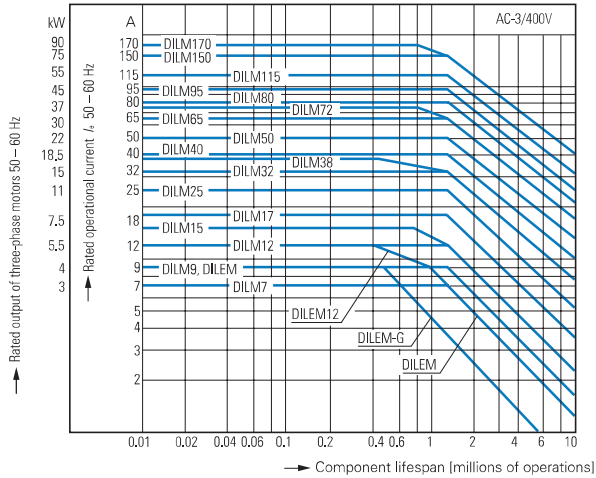

Normal AC induction motor

Operating characteristics

Make: from stop

Break: during run

Electrical characteristics:

Make: up to 6 X rated motor current

Break: 1 X rated motor current

Utilization category

100 % AC-3

Typical applications:

- | | | |
|--|-----------------|-----------------------|
| Compressors | Lifts | Mixers |
| Pumps | Escalators | Agitators |
| Fan | Conveyor belts | Centrifuges |
| Hinged flaps | Bucket-elevator | Air conditioning sys- |
| General drives for manufacturing and processing machines | | |

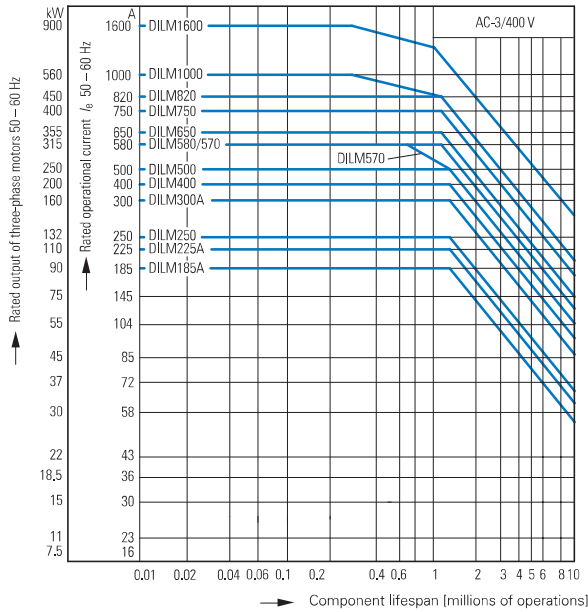

Extreme switching duty

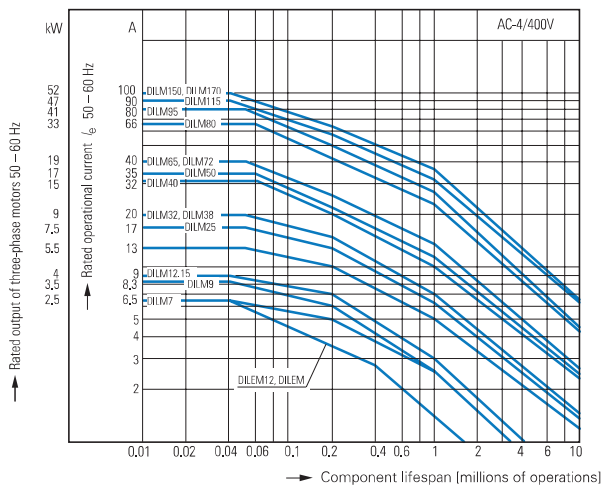

Normal AC induction motor

Operating characteristics

Inching, plugging, reversing

Electrical characteristics:

Make: up to 6 X rated motor current

Break: 6 X rated motor current

Utilization category

100 % AC-4

Typical applications:

- | | | |
|---|--------------|-------------|
| Printing machines | Wire-drawing | Centrifuges |
| Special drives on manufacturing and processing machines | | |

1.14

Contactors Switching conditions

1 Extreme switching duty

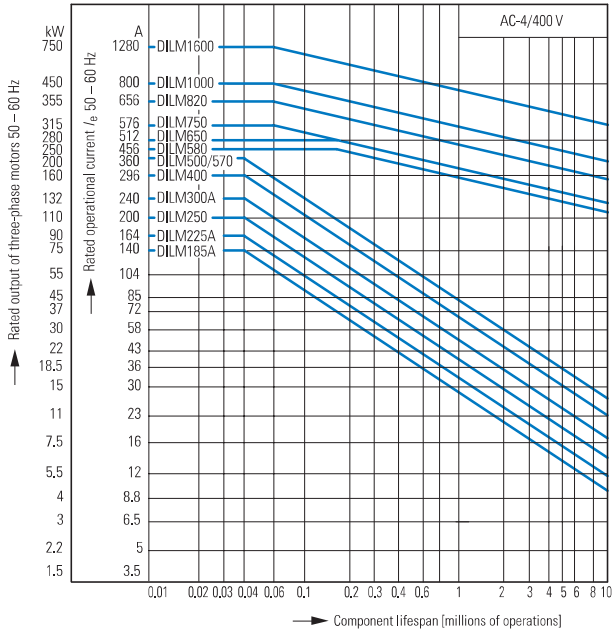

Normal AC induction motor

Operating characteristics

Inching, plugging, reversing

Electrical characteristics:

Make: up to 6 X rated motor current

Break: 6 X rated motor current

Utilization category

100% AC-4

Typical applications:

Printing machines Wire-drawing machines Centrifuges

Special drives on manufacturing and processing machines

Switching conditions for 3 pole, non-motor loads

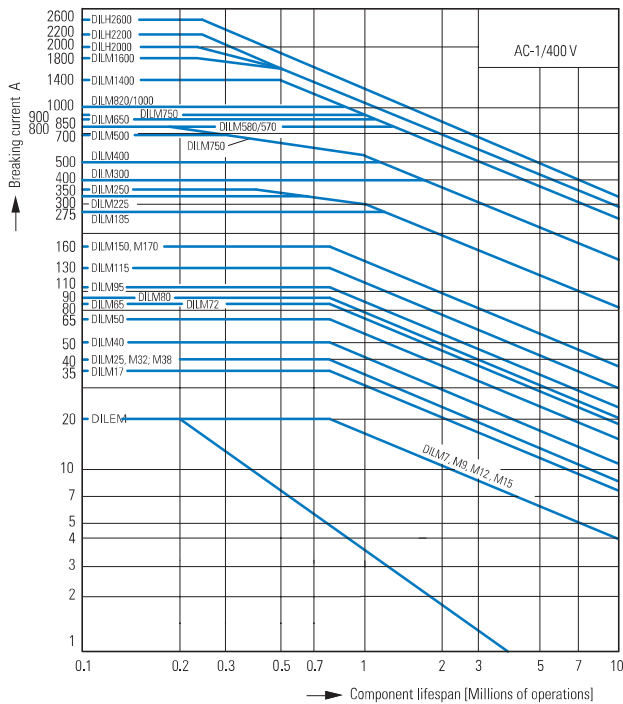

Operating characteristics

Non inductive and slightly inductive loads

Electrical characteristics:

Make: 1 X rated operational current

Break: 1 X rated operational current

Utilization category

100% AC-1

Typical applications:

Electric heat

Switching conditions for 4 pole, non-motor loads

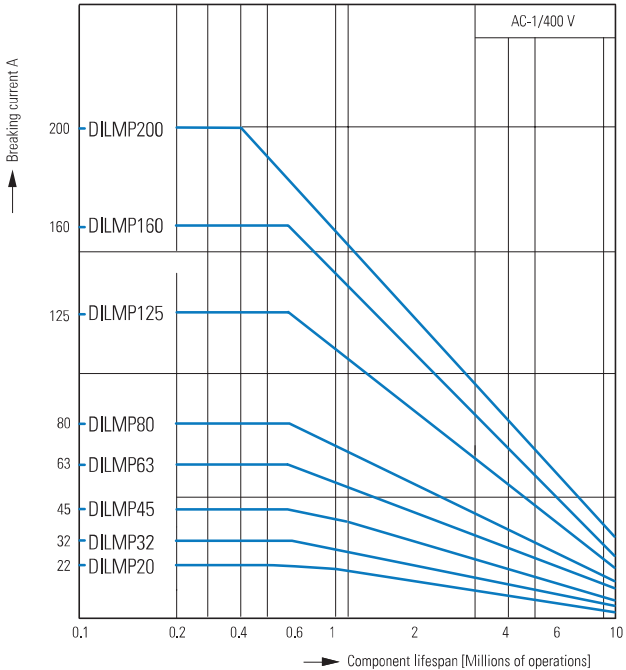

Operating characteristics
Non inductive and slightly inductive loads

Electrical characteristics:
Make: 1 X rated operational current
Break: 1 X rated operational current

Utilization category
100% AC-1

Typical applications:
Electric heat

1.14

Contactors Short-time loading

1 Short-time loading 3 pole

Time interval between two loads: 15 minutes

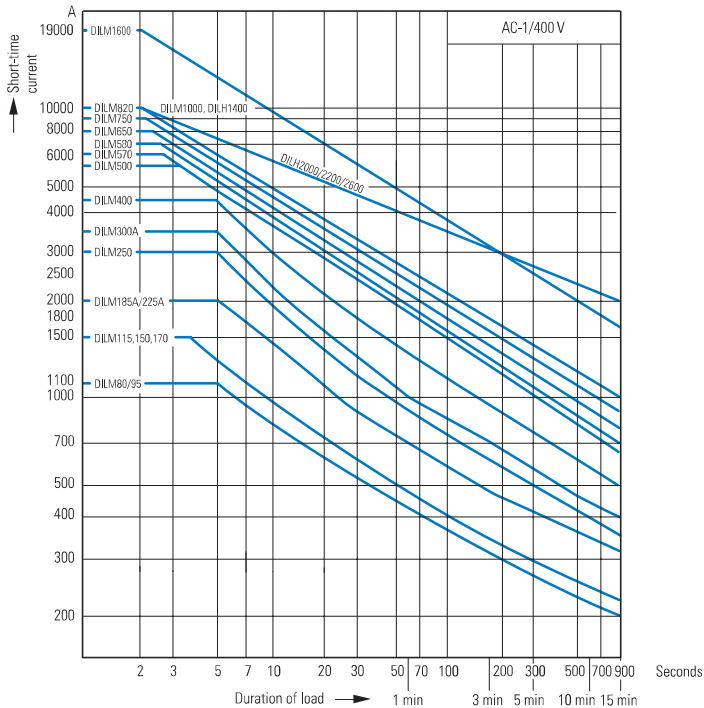
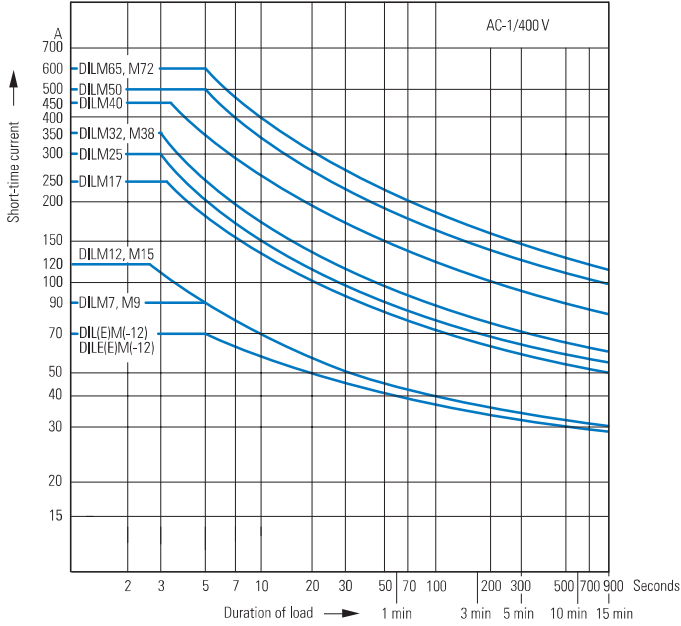

Determination of the maximum operating frequency dependent on the rating and utilization category (recommended values) for 400 V

P_N = max. rated motor output (kW) of respective contactor according to → Page 18 and → Page 4
S/h = max. operation per hour

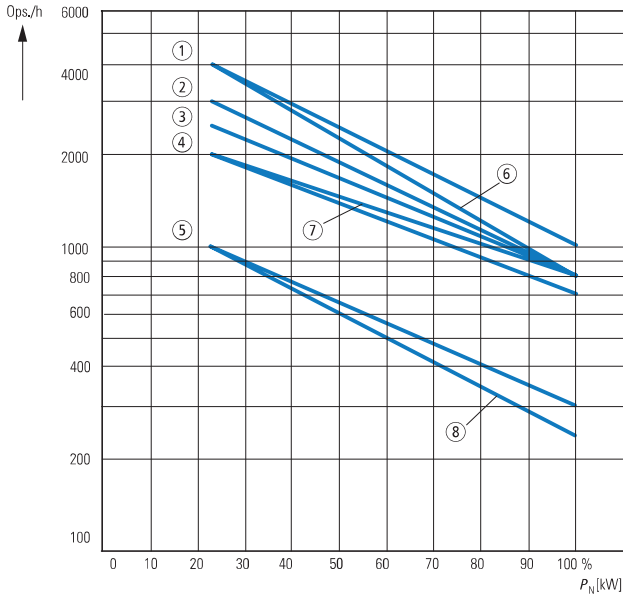

DILEM, DILM, DILH

Part no.	Characteristic AC-1	AC-3	AC-2 AC-4
DILE(E)M(-12)	7	6	8
DILM7, 9, 12, 15	3	1	5
DILM17, 25, 32, 38	3	2	5
DILM40, 50, 65, 72	3	2	5
DILM80, 95, 115, 150, 170	3	4	5

Determination of the maximum operating frequency dependent on the rating and utilization category (recommended values)

P_N = max. rated motor output (kW) of respective contactor according to → Page 28 and → Page 32
S/h = max. operation per hour

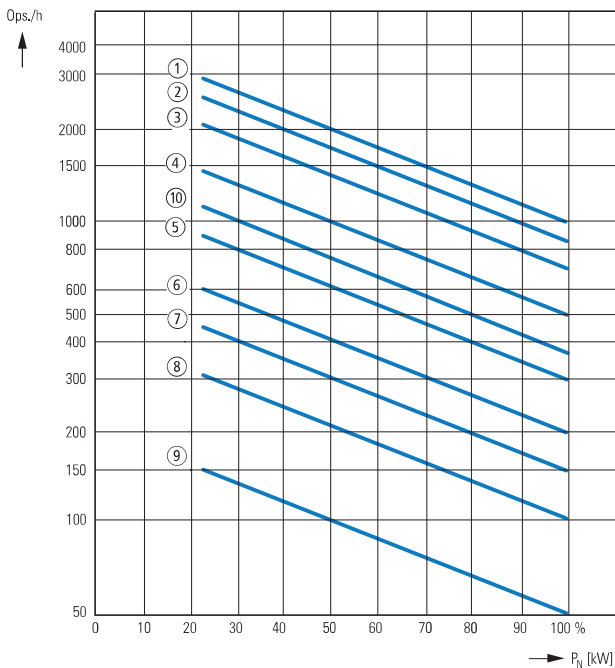

DILEM, DILM, DILH

Part no.	Characteristic AC-1	AC-3	AC-4
DILM185A	2	1	8
DILM225A	2	1	8
DILM250	2	1	8
DILM300A	3	2	9
DILM400	3	2	9
DILM500	3	2	9
DILM580	3	4	7
DILM650	3	4	7
DILM750	3	4	7
DILM820	3	4	7
DILM1000	3	4	7
DILM1600	10	10	7
DILH1400	10	-	-
DILH2000	10	-	-
DILH2200	10	-	-
DILH2600	10	-	-

1.14

Contactors

Switching of DC current

1 DC current switching

----- when necessary
conductor to be
supplied by customer

DILEEM ... DILM700

Without overload relay
≤ 60 V DC

> 60 V DC

With overload relay
> 60 V DC

1 pole

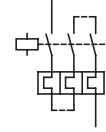

2 pole

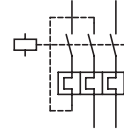

**DILEM4
DILMP...**

1 pole

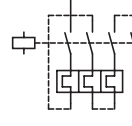
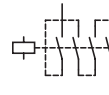

2 pole

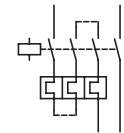

Wiring, star-delta combination with DILM32-XTEY20

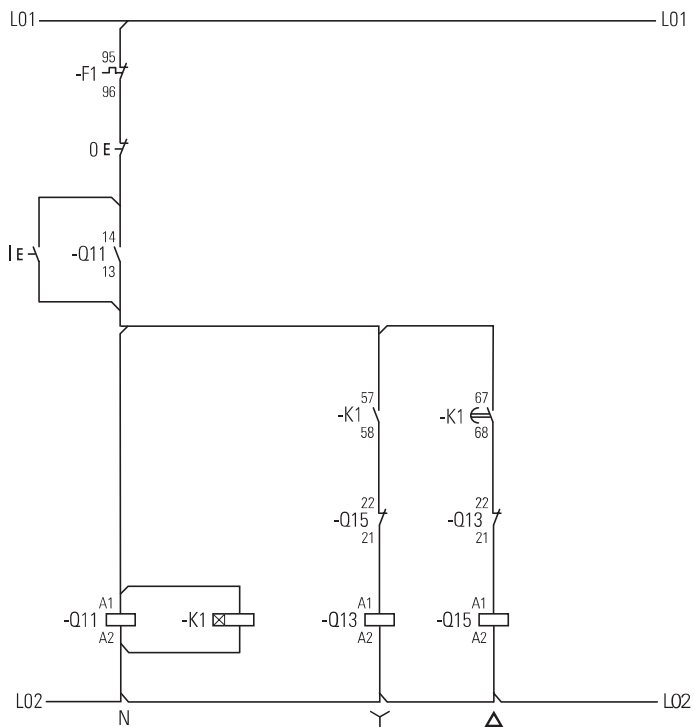

Technical data

1

DILER, DILA

		DILA	DILA...XHI	DILER	DILE...	
General						
Standards		IEC/EN 60947, VDE 0660, UL, CSA				
Lifespan, mechanical						
AC operated	Operations	x 10 ⁶ 20	10	10	10	
DC operated	Operations	x 10 ⁶ 20	10	20	20	
Maximum operating frequency						
Maximum operating frequency	Operations/h	9000	9000	9000	9000	
Climatic proofing						
		Damp heat, constant, to IEC 60068-2-78; Damp heat, cyclic, to IEC 60068-2-30				
Ambient temperature						
Open	°C	-25...60	-25...60	-25...50	-25...50	
Enclosed	°C	-25...40	-25...40	-25...40	-25...40	
Ambient temperature for storage	°C	-40 - 80	-40 - 80			
Mounting position						
					Any, except vertically with terminals A1/A2 below	
Mechanical shock resistance (IEC/EN 60068-2-27)						
Half-sinusoidal shock 10 ms						
Basic devices with auxiliary contact module						
		g	7	7	10	
		g	5	5	8	
Protection type						
		IP20	IP20	IP20	IP20	
Protection against direct contact when actuated from front (EN 50274)						
		Finger- and back-of-hand proof				
Weight						
AC operated	kg	0.23	0.05	0.17	—	
DC operated	kg	0.28	0.05	0.2	—	
Terminal capacity						
Screw terminals						
Solid	mm ²	1 x (0.75 - 4) 2 x (0.75 - 2.5)	1 x (0.75 - 4) 2 x (0.75 - 2.5)	1 x (0.75 - 2.5) 2 x (0.75 - 2.5)	1 x (0.75 - 2.5) 2 x (0.75 - 2.5)	
Flexible with ferrule	mm ²	1 x (0.75 - 2.5) 2 x (0.75 - 2.5)	1 x (0.75 - 2.5) 2 x (0.75 - 2.5)	1 x (0.75 - 1.5) 2 x (0.75 - 1.5)	1 x (0.75 - 1.5) 2 x (0.75 - 1.5)	
Solid or stranded	AWG	18 - 14	18 - 14	18 - 14	18 - 14	
Terminal screw		M3.5	M3.5	M3.5	M3.5	
Pozidriv screwdriver	Size	2	2	2	2	
Flat-blade screwdriver	mm	0.8 x 5.5 1 x 6	0.8 x 5.5 1 x 6	0.8 x 5.5 1 x 6	0.8 x 5.5 1 x 6	
Max. tightening torque	Nm	1.2	1.2	1.2	1.2	
Spring-loaded terminals						
Solid	mm ²	1 x (0.75 - 2.5) 2 x (0.75 - 2.5)	1 x (0.75 - 2.5) 2 x (0.75 - 2.5)	1 x (1 - 2.5) 2 x (1 - 2.5)	1 x (1 - 2.5) 2 x (1 - 2.5)	
Flexible with ferrule	mm ²	1 x (0.75 - 1.5) 2 x (0.75 - 1.5)	1 x (0.75 - 1.5) 2 x (0.75 - 1.5)	1 x (1 - 2.5) 2 x (1 - 2.5)	1 x (1 - 2.5) 2 x (1 - 2.5)	
Flexible without ferrule DIN 46228	mm ²	1 x (0.75 - 2.5) 2 x (0.75 - 2.5)	1 x (0.75 - 1.5) 2 x (0.75 - 1.5)	—	—	
Solid or stranded	AWG	18 - 14	18 - 14	1 x (16 - 14) 2 x (16 - 14)	1 x (16 - 14) 2 x (16 - 14)	
Flat-blade screwdriver	mm	0.6 x 3.5	0.6 x 3.5	0.6 x 3.5	0.6 x 3.5	

1.15

Mini contactor relays, contactor relays

1 DILER, DILA

			DILA	DILA...XHI	DILER	DILE...
Contacts						
Interlocked opposing contacts to EN 60947-4-1, Annex L, including auxiliary contact module			Yes	Yes	Yes	Yes
Rated impulse withstand voltage	U_{imp}	V AC	6000	6000	6000	6000
Overtoltage category/degree of pollution			III/3	III/3	III/3	III/3
Rated insulation voltage	U_i	V AC	690	690	690	690
Rated operating voltage	U_e	V AC	690	500	600	600
Safe isolation according to EN 61140						
Between coil and auxiliary contacts			V AC	400	400	300
Between the auxiliary contacts			V AC	400	400	300
Rated operational current						
AC-15						
220/240 V	I_e	A	4	4	6	4
380/415 V	I_e	A	4	4	3	2
500 V	I_e	A	1.5	1.5	1.5	1.5
DC ¹⁾						
L/R \leq 15 ms						
Contacts in series:						
1	24 V	A	10	10	2.5	2.5
1	60 V	A	6	6	–	–
2	60 V	A	10	10	2.5	2.5
1	110 V	A	3	3	–	–
3	110 V	A	6	6	1.5	1.5
1	220 V	A	1	1	–	–
3	220 V	A	5	5	0.5	0.5
L/R \leq 50 ms						
Contacts in series:						
3	24 V	A	4	2.5	–	–
3	60 V	A	4	1	–	–
3	110 V	A	2	0.5	–	–
3	220 V	A	1	0.25	–	–
DC-13 (6xP)						
Contacts in series:						
3	24 V	A	2.5	2.5	–	–
3	60 V	A	1	1	–	–
3	110 V	A	0.5	0.5	–	–
3	220 V	A	0.25	0.25	–	–
Control circuit reliability (at $U_e = 24$ V DC, $U_{min} = 17$ V, $I_{min} = 5.4$ mA)			Fault probability	λ	<10 ⁻⁸ , < one failure in 100 million operations	
Conventional thermal current			I_{th}	A	16	16
Short-circuit strength without welding						
Maximum overcurrent protection device						
220/240 V			PKZMO	4	–	4
380/415 V			PKZMO	4	–	4
Short-circuit protection rating maximum fuse ²⁾						
500 V			A gG/gL	10	10	6
500 V			A fast	–	–	10
Current heat loss at load of I_{th}						
AC operated			W	0.3	0.3	0.2
DC operated			W	0.3	0.3	0.3

Notes

¹⁾ Switch-on and switch-off conditions based on DC-13, time constant as specified

²⁾ See characteristic curve "Fuses" for time/current characteristics (please enquire)

DILER, DILA

			DILA	DILA...XHI	DILER	DILE...	
Magnet systems							
Voltage tolerance							
AC operated							
	Single-voltage coil 50 Hz and dual-voltage coil 50 Hz, 60 Hz	Pick-up	x U _c	0.8...1.1	–	0.8...1.1	–
	Dual-frequency coil 50/60 Hz	Pick-up	x U _c	0.8...1.1	–	0.85...1.1	–
DC operated ¹⁾							
	Starting voltage	Pick-up	x U _c	0.8...1.1	–	0.85...1.3	–
	At 24 V: without auxiliary contact module (40 °C)	Pick-up	x U _c	0.7 - 1.3	–	0.7 - 1.3	–
Power consumption							
	50 Hz	Pick-up	VA	24	–	25	–
	50 Hz	Sealing	VA	3.4	–	4.6	–
	50 Hz	Sealing	W	1.2	–	1.3	–
	60 Hz	Pick-up	VA	30	–	25	–
	60 Hz	Sealing	VA	4.4	–	4.6	–
	60 Hz	Sealing	W	1.4	–	1.3	–
	50/60 Hz	Pick-up	VA	27 25	–	30 29	–
	50/60 Hz	Sealing	VA	4.2 3.3	–	5.4 3.9	–
	50/60 Hz	Sealing	W	1.4 1.2	–	1.6 1.1	–
	DC operated	Pick-up = sealing	W	3	–	2.6	–
Duty factor			% DF	100	–	100	–
Changeover times at 100 % U _c (recommended values)							
	AC operated closing delay		ms	15 - 21	–	14 - 21	–
	AC operated normally open contact opening delay		ms	9 - 18	–	8 - 18	–
	AC operated with auxiliary contact module, max. closing delay		ms	–	–	45	45
	DC operated closing delay		ms	31	–	26 - 35	–
	DC operated normally open contact opening delay		ms	12	–	15 - 25	–
	DC operated with auxiliary contact module, max. closing delay		ms	–	–	70	70

Notes

¹⁾ Smoothed DC, three-phase bridge rectifier or smoothed two-phase bridge rectifier

1.15

Contactors

Amplifier modules, electronic timer module, contactor monitoring device

1 ETS-VS3, DILM, CMD

			ETS4-VS3	DILM32-XTE	CMD(24VDC) CMD(220-240VAC)
General					
Standards			IEC/EN 60947, VDE 0660, UL, CSA	DIN EN 61812, IEC/EN 60947, VDE 0660, UL, CSA	IEC/EN 60947 UL CSA
Lifespan, mechanical					
AC operated	c (contacts)	x 10 ⁶	–	3	10
DC operated	c (contacts)	x 10 ⁶	30	3	3
Maximum operating frequency					
DC operated	c (contacts)	x 10 ⁶	72000	–	9000
Climatic proofing			Damp heat, constant, to IEC 60068-2-78 Damp heat, cyclic, to IEC 60068-2-30		
Ambient temperature					
Storage		°C	–	-40 - 80	-40 - 80
Open		°C	-25 - 60	-25 - 60	-25 - 50
Enclosed		°C	-25 - 45	-25 - 40	–
Mounting position			Any	As required, except suspended	Any
Mechanical shock resistance (IEC/EN 60068-2-27)					
Half-sinusoidal shock 20 ms					
	N/O	g	10	–	–
Half-sinusoidal shock 10 ms					
	N/O	g	–	6	4
	NC	g	–	6	4
Protection type			IP20	IP20	IP20
Protection against direct contact when actuated from front (EN 50274)			Finger- and back-of-hand proof		
Weight		kg	0.09	0.08	0.1
Terminal capacity					
Solid		mm ²	1 x (0.75 - 2.5) 2 x (0.75 - 2.5) ¹⁾	1 x (0.75 - 2.5) 2 x (0.75 - 1.5)	1 x (0.75...2.5) 2 x (0.75...1.5)
Flexible with ferrule		mm ²	1 x (0.75 - 2.5) 2 x (0.75 - 1.5) ¹⁾	1 x (0.75 - 1.5) 2 x (0.75 - 1.5)	1 x (0.75...1.5) 2 x (0.75...1.5)
Solid or stranded		AWG	16 - 14	18 - 14	18...14
Terminal screw			M3.5	M3.5	M3.5
Pozidriv screwdriver		Size	2	2	2
Flat-blade screwdriver		mm	0.8 x 5.5 1 x 6	0.8 x 5.5 1 x 6	0.8 x 5.5 1 x 6
Max. tightening torque		Nm	1.2	1.2	1.2

Notes

¹⁾ Use equal cross-sections only

ETS-VS3, DILM, CMD

1

			ETS4-VS3	DILM32-XTE	CMD(24VDC)	CMD(220-240VAC)
Contacts						
Rated impulse withstand voltage	U_{imp}	V AC	6000	6000	8000	4000
Overvoltage category/degree of pollution			III/2	III/3	III/3	III/3
Rated insulation voltage	U_i	V AC	440	600	100	250
Rated operating voltage	U_e	V	440 AC	400 AC	24 DC	250 AC
Rated operational current						
AC-15						
220/240 V	I_e	A	2	3	–	–
380/415 V	I_e	A	2	–	–	–
DC-13 ¹⁾						
DC-13 L/R ≤ 15 ms						
Contacts in series:						
1	24 V	A	2.6	1	–	–
1	60 V	A	1	0.2	–	–
1	110 V	A	0.6	0.2	–	–
1	220 V	A	0.2	0.1	–	–
DC-13 L/R ≤ 50 ms						
Contacts in series:						
1	24 V	A	2	1	–	–
1	60 V	A	0.6	0.2	–	–
1	110 V	A	0.08	0.2	–	–
1	220 V	A	0.08	0.1	–	–
DC-13 L/R ≤ 300 ms						
Contacts in series:						
1	24 V	A	0.6	1	–	–
1	60 V	A	0.2	0.2	–	–
1	110 V	A	0.08	0.2	–	–
1	220 V	A	0.03	0.1	–	–
Safe isolation according to EN 61140						
Between coil and auxiliary contacts		V AC	–	250	–	–
Between the auxiliary contacts		V AC	–	250	–	–
Control circuit reliability (at $U_e = 24$ V DC, $U_{min} = 17$ V, $I_{min} = 5.4$ mA)	Fault probability	λ	$<10^{-8}$, $< one failure in 100 million operations$	–	–	–
Conventional thermal current	I_{th}	A	6	4	–	–
Component lifespan						
AC-15						
230 V, $I_e = 0.1$ A	Switch operations	$\times 10^6$	7	–	–	–
230 V, $I_e = 1.2$ A	Switch operations	$\times 10^6$	1	–	–	–
Short-circuit rating without welding						
Short-circuit protection rating maximum fuse ²⁾						
500 V		A gG/gL	–	4	2	2
500 V		A fast	4	–	–	–

Notes

- ¹⁾ Switch-on and switch-off conditions based on DC-13, time constant as specified
- ²⁾ See transparent overlay "Fuses" for time/current characteristics (please enquire)

1.15

Contactors

Amplifier modules, electronic timer module, contactor monitoring device

1 ETS-VS3, DILM, CMD

			ETS4-VS3	DILM32-XTE	CMD(24VDC) CMD(220-240VAC)
Magnet systems					
Voltage tolerance					
Starting voltage					
AC operated					
	Pick-up	x U _c	–	0.85 - 1.1	0.85 - 1.1
DC operated ¹⁾					
	Pick-up	x U _c	0.85 - 1.2	0.7 - 1.2	0.85 - 1.1
Power consumption					
AC operated	Sealing	VA	–	2	4
AC operated	Sealing	W	–	1.8	4
DC operated	Pick-up = sealing	W	0.6	–	4
Duty factor		% DF	100	100	100
Changeover times at 100 % U _c (recommended values)					
DC operated closing delay		ms	7	–	–
DC operated opening delay		ms	3	–	–
Maximum operating frequency					
Max. operating frequency		Ops/h	–	3600	–
6 A/250 V		Ops/h	–	360	–
Minimum on duration					
On-delayed		ms	–	< 50	–
Off-delayed		ms	–	< 200	–
Repetition accuracy (with constant parameters)	Deviation	%	–	< 5	–
Recovery time (after 100% time delay)		ms	–	70	–
Contact changeover time					
DILM32-XTEE11/DILM32-XTED11	t _u	ms	–	10	–
DILM32-XTEY20	t _u	ms	–	50	–
CMD	t _u	ms	–	–	100 ± 20%

Notes

¹⁾ Smoothed DC, three-phase bridge rectifier or smoothed two-phase bridge rectifier

DILEEM, DILEM

1

			DILEEM DILEM DILEM12	DILEEM-G DILEM-G DILEM12-G	DILEM4	DILEM4-G
General						
Standards			IEC/EN 60947, VDE 0660, CSA, UL			
Lifespan, mechanical; Coil 50/60 Hz	at 50 Hz		7	–	7	–
Lifespan, mechanical	c (contacts)	x 10 ⁶	10	20	20	–
Maximum operating frequency						
	Mechanical	Ops/h	9000			
	Electrical (Contactor without overload relay)		→ Characteristic curves Page 91			
Climatic proofing						
			Damp heat, constant, to IEC 60068-2-78			
			Damp heat, cyclic, to IEC 60068-2-30			
Ambient temperature						
	Open	°C	-25 - 50			
	Enclosed	°C	-25 - 40			
Mounting position						
			Any, except for vertically with terminals A1/A2 below			
						
Mechanical shock resistance (IEC/EN 60068-2-27)						
Half-sinusoidal shock 10 ms						
Basic device without auxiliary contact module						
	Main circuit normally open contact	g	10			
	Auxiliary contacts NC/Normally open contact	g	10/8	10/8	–	–
Basic devices with auxiliary contact module						
	Main circuit normally open contact	g	10			
	Auxiliary contacts Normally open contact/NC	g	20/20			
Protection type						
			IP20			
Protection against direct contact when actuated from front (EN 50274)						
			Finger- and back-of-hand proof			
Weight						
		kg	0.2	0.17	0.2	0.17
Terminal capacity: main and auxiliary contacts						
	Solid	mm ²	1 x (0.75 - 2.5) 2 x (0.75 - 2.5)			
	Flexible with ferrule	mm ²	1 x (0.75 - 1.5) 2 x (0.75 - 1.5)			
	Solid or stranded	AWG	18 - 14			
Terminal screw						
			M3.5			
Pozi driv screwdriver						
			Size 2			
Flat-blade screwdriver						
			mm 0.8 x 5.5 1 x 6			
Max. tightening torque						
			Nm 1.2			
Terminal capacity springloaded terminals main and control circuits						
	Solid	mm ²	1 x (1 - 2.5) 2 x (1 - 2.5)			
	Flexible with ferrule	mm ²	1 x (1 - 2.5) 2 x (1 - 2.5)			
Flat-blade screwdriver						
			mm 0.6 x 3.5			

1.15 Mini contactor relays

DILEEM, DILEM

1

			DILEEM DILEEM-G	DILEM DILEM-G	DILEM4	DILEM4-G	DILEM12 DILEM12-G		
Main contacts									
Rated impulse withstand voltage	U_{imp}	V AC	6000	6000	6000	6000	6000		
Overvoltage category/pollution degree			III/3	III/3	III/3	III/3	III/3		
Rated insulation voltage	U_i	V AC	690	690	690	690	690		
Rated operating voltage	U_e	V AC	690	690	690	690	690		
Safe isolation according to EN 61140									
Between coil and contacts		V AC	300	300	300	300	300		
Between the contacts		V AC	300	300	300	300	300		
Making capacity of up to 440 V (cos Φ as specified in IEC/EN 60947)									
Breaking capacity	220/230 V	A	90	90	90	90	96		
	380/400 V	A	90	90	90	90	96		
	500 V	A	64	64	64	64	72		
	660/690 V	A	42	42	42	42	42		
Devices lifespan	AC-1		→ Engineering Page 88						
	AC-3		→ Engineering Page 87						
	AC-4		→ Engineering Page 87						
Short-circuit protection rating maximum fuse									
	Type "2" coordination 500 V	gL/gG	A	10	10	10	20		
	Type "1" coordination 500 V	gL/gG	A	20	20	20	35		
AC voltage									
AC-1 operation									
Conventional thermal current 3 pole 50 - 60 Hz									
Open	at 40 °C	I_{th}	A	22	22	22	22		
		I_{th}	A	20	20	20	20		
		I_{th}	A	19	19	19	19		
Enclosed ¹⁾		I_{th}	A	16	16	16	16		
Conventional thermal current, 1-pole									
	Open ¹⁾		I_{th}	A	50	60	60	50	
	Enclosed ¹⁾		I_{th}	A	40	50	50	40	
AC-3 operation									
Rated operational current AC-3 open, 50 - 60 Hz, 3-pole ¹⁾	220/230 V	I_e	A	6.6	9	9	9	12	
	240 V	I_e	A	6.6	9	9	9	12	
	380/400 V	I_e	A	6.6	9	9	9	12	
	415 V	I_e	A	6.6	9	9	9	12	
	440 V	I_e	A	6.6	9	9	9	10.5	
	500 V	I_e	A	5	6.4	6.4	6.4	9	
Motor rating	660/690 V	I_e	A	3.5	4.8	4.8	4.8	5.2	
	220/230 V	P	kW	1.5	2.2	2.2	2.2	3.5	
	240 V	P	kW	1.8	2.5	2.5	2.5	3	
	380/400 V	P	kW	3	4	4	4	5.5	
	415 V	P	kW	3.1	4.3	4.3	4.3	5.5	
	440 V	P	kW	3.3	4.6	4.6	4.6	5.5	
AC-4 operation	500 V	P	kW	3	4	4	4	5.5	
	660/690 V	P	kW	3	4	4	4	4	
	Rated operational current AC-4 open, 50 - 60 Hz, 3-pole ¹⁾	220/230 V	I_e	A	5	6.6	6.6	6.6	6.6
		240 V	I_e	A	5	6.6	6.6	6.6	6.6
		380/400 V	I_e	A	5	6.6	6.6	6.6	6.6
		415 V	I_e	A	5	6.6	6.6	6.6	6.6
440 V		I_e	A	5	6.6	6.6	6.6	6.6	
500 V		I_e	A	3.7	5	5	5	5	
Rated operational power	660/690 V	I_e	A	2.9	3.4	3.4	3.4	3.4	
	220/230 V	P	kW	1.1	1.5	1.5	1.5	1.5	
	240 V	P	kW	1.3	1.8	1.8	1.8	1.8	
	380/400 V	P	kW	2.2	3	3	3	3	
	415 V	P	kW	2.3	3.1	3.1	3.1	3.1	
	440 V	P	kW	2.4	3.3	3.3	3.3	3.3	
500 V	P	kW	2.2	3	3	3	2.2		
660/690 V	P	kW	2.2	3	3	3	2.2		

Notes

¹⁾ At maximum permissible ambient air temperature

DILEEM, DILEM

1

		DILEEM	DILEEM-G	DILEM	DILEM-G	DILEM4	DILEM4-G	DILEM12	DILEM12-G		
DC voltage											
Operations → Engineering Page 92											
Rated operational current open											
DC-1	12 V	I _e	A	20	20	20	20	20	20	20	
	24 V	I _e	A	20	20	20	20	20	20	20	
	60 V	I _e	A	20	20	20	20	20	20	20	
	110 V	I _e	A	20	20	20	20	20	20	20	
	220 V	I _e	A	20	20	20	20	20	20	20	
DC-3	12 V	I _e	A	6	6	8	8	8	8	8	
	24 V	I _e	A	6	6	8	8	8	6	8	
	60 V	I _e	A	3	3	4	4	4	4	4	
	110 V	I _e	A	2	2	3	3	3	3	3	
	220 V	I _e	A	–	–	–	–	1	1	–	–
DC-5	12 V	I _e	A	1.8	1.8	2.5	2.5	2.5	2.5	2.5	
	24 V	I _e	A	1.8	1.8	2.5	2.5	2.5	2.5	2.5	
	60 V	I _e	A	1.8	1.8	2.5	2.5	2.5	2.5	2.5	
	110 V	I _e	A	1.8	1.8	1.5	1.5	2.5	2.5	1.5	
	220 V	I _e	A	0.2	0.2	0.3	0.3	1	1	0.3	0.3
Current heat loss (3-pole or 4-pole)											
At I _{th}			W	2	3.5	2	3.5	2.7	4.7	2	3.5
At I _e to AC-3/400 V			W	0.5	0.7	0.5	0.7	–	–	0.5	0.7
Magnet systems											
Voltage tolerance											
Single-voltage coil 50 Hz and dual-voltage coil 50 Hz, 60 Hz		Pick-up	x U _c	0.8 - 1.1	–	0.8 - 1.1	–	0.8 - 1.1	–	0.8 - 1.1	–
Dual-frequency coil 50/60 Hz		Pick-up	x U _c	0.8 - 1.1	–	0.85 - 1.1	–	0.85 - 1.1	–	0.8 - 1.1	–
DC operated		Pick-up	x U _c	–	0.8 - 1.1	–	0.8 - 1.1	–	0.85 - 1.1	–	0.8 - 1.1
Power consumption											
AC operation	Single-voltage coil, 50 Hz, and dual-voltage coil, 50 Hz, 60 Hz	Pick-up	VA	25	–	25	–	25	–	25	–
		Pick-up	W	22	–	22	–	22	–	22	–
		Sealing	VA	4.6	–	4.6	–	4.6	–	4.6	–
		Sealing	W	1.3	–	1.3	–	1.3	–	1.3	–
	Dual-frequency coil 50/60 Hz at 50 Hz	Pick-up	VA	30	–	30	–	30	–	30	–
		Pick-up	W	26	–	26	–	26	–	26	–
		Sealing	VA	5.4	–	5.4	–	5.4	–	5.4	–
		Sealing	W	1.6	–	1.6	–	1.6	–	1.6	–
	Dual-frequency coil 50/60 Hz at 60 Hz	Pick-up	VA	29	–	29	–	29	–	29	–
		Pick-up	W	24	–	24	–	24	–	24	–
		Sealing	VA	3.9	–	3.9	–	3.9	–	3.9	–
		Sealing	W	1.1	–	1.1	–	1.1	–	1.1	–
Single-voltage coil, 50 Hz, and dual-voltage coil, 50 Hz, 60 Hz	Pick-up	VA	25	–	25	–	25	–	25	–	
	Pick-up	VA	30	–	30	–	30	–	30	–	
	Pick-up	VA	29	–	29	–	29	–	29	–	
	Pick-up	VA	29	–	29	–	29	–	29	–	
DC operation ¹⁾	Power consumption pick-up = sealing		VA/W	–	2.6	–	2.6	–	2.6	–	2.6
Duty factor			% DF	100	100	100	100	100	100	100	
Switching times at 100 % U _c											
N/O	Closing delay min.		ms	14	26	14	26	14	26	14	26
	Closing delay max.		ms	21	35	21	35	21	35	21	35
	Opening delay min.		ms	8	15	8	15	8	15	8	15
	Opening delay max.		ms	18	25	18	25	18	25	18	25
	Closing delay with top mounting auxiliary contact		ms	Max. 45	Max. 70	Max. 45	Max. 70	Max. 45	Max. 70	Max. 45	Max. 70
Reversing con-	Changeover time at 110 % U _c factors										
	Changeover time min.		ms	16	40	16	40	16	40	16	40
	Changeover time max.		ms	21	50	21	50	21	50	21	50
Coil	Arcing time at 690 V AC			ms	Max. 12	Max. 12	Max. 12	Max. 12	Max. 12	Max. 12	Max. 12
	Lifespan, mechanical; Coil 50/60 Hz			c (contacts)	x 10 ⁶	7	–	7	–	7	–

Notes

¹⁾ Smoothed DC or three-phase bridge rectifier

1.15 Mini contactor relays

DILEEM, DILEM

1

		DILE(E)M(-12)...		...DILEM
Auxiliary contact				
Interlocked opposing contacts to EN 60947-5-1 Annex L, including auxiliary contact module		Yes		Yes
Rated impulse withstand voltage	U_{imp}	V AC	6000	6000
Overvoltage category/pollution degree		III/3		III/3
Rated insulation voltage	U_i	V AC	690	690
Rated operating voltage	U_e	V AC	600	600
Safe isolation according to EN 61140				
Between coil and auxiliary contacts		V AC	300	300
Between the auxiliary contacts		V AC	300	300
Rated operational current				
AC-15				
	220/240 V	I_e	A	6
	380/415 V	I_e	A	3
	500 V	I_e	A	1.5
DC				
	$L/R \leq 15$ ms			
Contacts in series:				
	1	24 V	A	2.5
	2	60 V	A	2.5
	3	100 V	A	1.5
	3	220 V	A	0.5
Conventional thermal current		I_{th}	A	10
Control circuit reliability (at $U_e = 24$ V DC, $U_{min} = 17$ V, $I_{min} = 5.4$ mA)		Fault probability	λ	$<10^{-8}$, < one failure in 100 million operations
Component lifespan at $U_e = 240$ V				
AC-15		c (contacts)	$\times 10^6$	0.2
DC ¹⁾				
$L/R = 50$ ms: 2 contacts in series at $I_e = 0.5$ A		c (contacts)	$\times 10^6$	0.15
Short-circuit rating without welding				
Maximum overcurrent protective device			PKZM0-4	PKZM0-4
Short-circuit protection rating maximum fuse				
500 V		A gG/gL	6	6
500 V		A fast	10	10
Current heat loss at load of I_{th}				
Per contact		W	0.2	0.2

Notes

¹⁾ Switch-on and switch-off conditions based on DC-13, time constant as specified

1.15

Contactors

Basic devices up to 170 A

DILM7 ... DILM170

1

			DILM7	DILM9	DILM12	DILM15	DILM17	DILM25
General								
Standards			IEC/EN 60947, VDE 0660, UL, CSA					
Lifespan, mechanical								
AC operated	c (contacts)	x 10 ⁶	10	10	10	10	10	10
DC operated	c (contacts)	x 10 ⁶	10	10	10	10	10	10
Operating frequency, mechanical								
Mechanical, AC operated	Operations/h		9000	9000	9000	5000	5000	5000
DC operated	Operations/h		9000	9000	9000	5000	5000	5000
Maximum operating frequency			→ Characteristic curves Page 74					
Electrical (Contactor without overload relay)								
Climatic proofing			Damp heat, constant, to IEC 60068-2-78 Damp heat, cyclic, to IEC 60068-2-30					
Ambient temperature								
Open	°C		-25...60	-25...60	-25...60	-25...60	-25...60	-25...60
Enclosed	°C		-25...40	-25...40	-25...40	-25...40	-25...40	-25...40
Storage	°C		-40 - 80	-40 - 80	-40 - 80	-40 - 80	-40 - 80	-40 - 80
Mounting position AC- and DC operated								
Mechanical shock resistance (IEC/EN 60068-2-27)								
Half-sinusoidal shock 10 ms								
Main contacts								
N/O	g		10	10	10	10	10	10
Auxiliary contacts								
N/O	g		7	7	7	7	7	7
NC	g		5	5	5	5	5	5
Mechanical shock resistance (IEC/EN 60068-2-27) with table mounting								
Half-sinusoidal shock 10 ms								
Main contacts								
N/O	g		5.7	5.7	5.7	5.7	6.9	6.9
Auxiliary contacts								
N/O	g		3.4	3.4	3.4	3.4	5.3	5.3
NC	g		3.4	3.4	3.4	3.4	3.5	3.5
Protection type			IP20 IP20 IP20 IP20 IP00 IP00					
Protection against direct contact when actuated from front (EN 50274)			Finger- and back-of-hand proof					
Weight								
AC operated	kg		0.23	0.23	0.23	0.23	0.42	0.42
DC operated	kg		0.28	0.28	0.28	0.28	0.48	0.48
Terminal type, screw connection								
Terminal capacity of main cable								
Solid	mm ²		1 x (0.75 - 4) 2 x (0.75 - 2.5)				1 x (0.75 - 16) 2 x (0.75 - 10)	
Flexible with ferrule	mm ²		1 x (0.75 - 2.5) 2 x (0.75 - 2.5) ¹⁾				1 x (0.75 - 16) 2 x (0.75 - 10)	
Stranded	mm ²		-				1 x 16 1 x 16	
Solid or stranded	AWG		18 - 10 18 - 10 18 - 10 18 - 10				18 - 6 18 - 6	
Flat conductor	mm	Number of layers x width x thickness	-				-	
Terminal capacity of control circuit cable								
Solid	mm ²		1 x (0.75 - 4) 2 x (0.75 - 2.5)				1 x (0.75 - 4) 2 x (0.75 - 4)	
Flexible with ferrule	mm ²		1 x (0.75 - 2.5) 2 x (0.75 - 2.5)				1 x (0.75 - 2.5) 2 x (0.75 - 2.5)	
Solid or stranded	AWG		18 - 10 18 - 10 18 - 10 18 - 10				18 - 14 18 - 14	

Notes

¹⁾ Also without ferrule.

DILM32	DILM38	DILM40	DILM50	DILM65	DILM72	DILM80	DILM95	DILM115	DILM150	DILM170
--------	--------	--------	--------	--------	--------	--------	--------	---------	---------	---------

IEC/EN 60947, VDE 0660, UL, CSA

10	10	10	10	10	10	10	10	10	10	10
10	10	10	10	10	10	10	10	10	10	10
5000	5000	5000	5000	5000	5000	3600	3600	3600	3600	3000
5000	5000	5000	5000	5000	5000	3600	3600	3600	3600	3000

→ Characteristic curves Page 74

Damp heat, constant, to IEC 60068-2-78

Damp heat, cyclic, to IEC 60068-2-30

-25...60	-25...60	-25...60	-25...60	-25...60	-25...60	-25...60	-25...60	-25...60	-25...60	-25...60
-25...40	-25...40	-25...40	-25...40	-25...40	-25...40	-25...40	-25...40	-25...40	-25...40	-25...40
-40 - 80	-40 - 80	-40 - 80	-40 - 80	-40 - 80	-40 - 80	-40 - 80	-40 - 80	-40 - 80	-40 - 80	-40 - 80

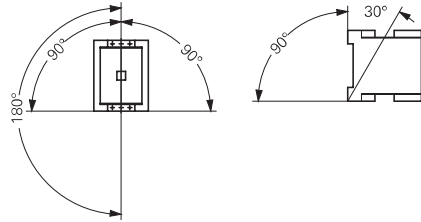

10	10	10	10	10	10	10	10	10	10	10
7	7	7	7	7	7	7	7	7	7	7
5	5	5	5	5	5	5	5	5	5	5

6.9	6.9	10	10	10	10	10	10	10	10	10
5.3	5.3	7	7	7	7	7	7	7	7	7
3.5	3.5	5	5	5	5	5	5	5	5	5
IP00	IP00	IP00	IP00	IP00	IP00	IP00	IP00	IP00	IP00	IP00

Finger- and back-of-hand proof

0.42	0.42	0.9	0.9	0.9	0.9	2	2	2	2	2
0.48	0.48	1.1	1.1	1.1	1.1	2.1	2.1	2.1	2.1	2.1

1 x (0.75 - 16)		1 x (0.75 - 16)				-	-	-	-	-
2 x (0.75 - 10)		2 x (0.75 - 16)								
1 x (0.75 - 16)		1 x (0.75 - 35)				1 x (10 - 95)				
2 x (0.75 - 10)		2 x (0.75 - 25)				2 x (10 - 70)				
1 x 16	1 x 16	1 x (16 - 50)				1 x (16 - 95)				
		2 x (16 - 35)				2 x (16 - 70)				
18 - 6	18 - 6	12 - 2	12 - 2	12 - 2	12 - 2	8...3/0	8...3/0	8...3/0	8...3/0	8...3/0
-	-	2 x (6 x 9 x 0.8)				2 x (6 x 16 x 0.8)				

1 x (0.75 - 4)
2 x (0.75 - 4)
1 x (0.75 - 2.5)
2 x (0.75 - 2.5)

18 - 14	18 - 14	18 - 14	18 - 14	18 - 14	18 - 14	18 - 14	18 - 14	18 - 14	18 - 14	18 - 14
---------	---------	---------	---------	---------	---------	---------	---------	---------	---------	---------

1.15

Contactors

Basic devices up to 170 A

1 DILM7 ... DILM170

			DILM7	DILM9	DILM12	DILM15	DILM17	DILM25
General								
Main cable connection screw/bolt			M3.5	M3.5	M3.5	M3.5	M5	M5
Tightening torque	Nm		1.2	1.2	1.2	1.2	3.2	3.2
Control circuit cable connection screw/bolt			M3.5	M3.5	M3.5	M3.5	M3.5	M3.5
Tightening torque	Nm		1.2	1.2	1.2	1.2	1.2	1.2
Tools								
Main conductors								
Pozidriv screwdriver		Size	2	2	2	2	2	2
Internal hexagon	SW	mm	–	–	–	–	–	–
Flat-blade screwdriver		mm	0.8 x 5.5 1 x 6	0.8 x 5.5 1 x 6	0.8 x 5.5 1 x 6	0.8 x 5.5 1 x 6	0.8 x 5.5 1 x 6	0.8 x 5.5 1 x 6
Auxiliary conductors								
Pozidriv screwdriver		Size	2	2	2	2	2	2
Flat-blade screwdriver		mm	0.8 x 5.5 1 x 6	0.8 x 5.5 1 x 6	0.8 x 5.5 1 x 6	0.8 x 5.5 1 x 6	0.8 x 5.5 1 x 6	0.8 x 5.5 1 x 6
Terminal type spring-cage terminal								
Terminal capacity of main cable								
Solid		mm ²	1 x (0.75 - 2.5) 2 x (0.75 - 2.5)				–	–
Flexible		mm ²	1 x (0.75 - 2.5) 2 x (0.75 - 2.5)				–	–
Flexible with ferrule		mm ²	1 x (0.75 - 1.5) 2 x (0.75 - 1.5)				–	–
Flexible without ferrule		mm ²	1 x (0.75 - 2.5) 2 x (0.75 - 2.5)				–	–
Solid or stranded		AWG	18 - 14	18 - 14	18 - 14	18 - 14	–	–
Terminal capacity of control circuit cable								
Solid		mm ²	1 x (0.75 - 2.5) 2 x (0.75 - 2.5)					
Flexible		mm ²	1 x (0.75 - 2.5) 2 x (0.75 - 2.5)					
Flexible with ferrule		mm ²	1 x (0.75 - 1.5) 2 x (0.75 - 1.5)					
Flexible without ferrule		mm ²	1 x (0.75 - 2.5) 2 x (0.75 - 2.5)				–	–
Solid or stranded		AWG	18 - 14	18 - 14	18 - 14	18 - 14	18 - 14	18 - 14
Tools								
Strip length		mm	10	10	10	10	10	10
Screwdriver blade width		mm	3.5	3.5	3.5	3.5	3.5	3.5
Main contacts								
Rated impulse withstand voltage	U _{imp}	V AC	8000	8000	8000	8000	8000	8000
Overvoltage category/pollution degree			III/3	III/3	III/3	III/3	III/3	III/3
Rated insulation voltage	U _i	V AC	690	690	690	690	690	690
Rated operating voltage	U _e	V AC	690	690	690	690	690	690
Safe isolation according to EN 61140								
Between coil and contacts		V AC	400	400	400	400	440	440
Between the contacts		V AC	400	400	400	400	440	440
Making capacity (cos φ to IEC/EN 60947)	To 690 V	A	112	112	144	155	238	350
Breaking capacity								
230 V		A	70	90	120	124	170	250
380/400 V		A	70	90	120	124	170	250
500 V		A	50	70	100	100	170	250
660/690 V		A	40	50	70	70	120	150
Short-circuit rating								
Short-circuit protection rating maximum fuse								
Type "2" coordination								
400 V	gG/gL 500 V	A	20	20	20	20	35	35
690 V	gG/gL 690 V	A	16	16	20	20	35	35
Type "1" coordination								
400 V	gG/gL 500 V	A	35	35	35	63	63	100
690 V	gG/gL 690 V	A	20	20	25	50	50	50

DILM32	DILM38	DILM40	DILM50	DILM65	DILM72	DILM80	DILM95	DILM115	DILM150	DILM170
M5	M5	M6	M6	M6	M6	M10	M10	M10	M10	M10
3.2	3.2	3.3	3.3	3.3	3.3	14	14	14	14	14
M3.5	M3.5	M3.5	M3.5	M3.5	M3.5	M3.5	M3.5	M3.5	M3.5	M3.5
1.2	1.2	1.2	1.2	1.2	1.2	1.2	1.2	1.2	1.2	1.2
2	2	2	2	2	2	—	—	—	—	—
—	—	—	—	—	—	5	5	5	5	5
0.8 x 5.5 1 x 6	0.8 x 5.5 1 x 6	0.8 x 5.5 1 x 6	0.8 x 5.5 1 x 6	0.8 x 5.5 1 x 6	0.8 x 5.5 1 x 6	—	—	—	—	—
2	2	2	2	2	2	2	2	2	2	2
0.8 x 5.5 1 x 6	0.8 x 5.5 1 x 6	0.8 x 5.5 1 x 6	0.8 x 5.5 1 x 6	0.8 x 5.5 1 x 6	0.8 x 5.5 1 x 6	0.8 x 5.5 1 x 6	0.8 x 5.5 1 x 6	0.8 x 5.5 1 x 6	0.8 x 5.5 1 x 6	0.8 x 5.5 1 x 6
—	—	—	—	—	—	—	—	—	—	—
—	—	—	—	—	—	—	—	—	—	—
—	—	—	—	—	—	—	—	—	—	—
—	—	—	—	—	—	—	—	—	—	—
—	—	—	—	—	—	—	—	—	—	—
1 x (0.75 - 2.5) 2 x (0.75 - 2.5)										
1 x (0.75 - 2.5) 2 x (0.75 - 2.5)										
1 x (0.75 - 1.5) 2 x (0.75 - 1.5)										
—	—	—	—	—	—	—	—	—	—	—
18 - 14	18 - 14	18 - 14	18 - 14	18 - 14	18 - 14	18 - 14	18 - 14	18 - 14	18 - 14	18 - 14
10	10	10	10	10	10	10	10	10	10	10
3.5	3.5	3.5	3.5	3.5	3.5	3.5	3.5	3.5	3.5	3.5
8000	8000	8000	8000	8000	8000	8000	8000	8000	8000	8000
III/3	III/3	III/3	III/3	III/3	III/3	III/3	III/3	III/3	III/3	III/3
690	690	690	690	690	690	690	690	690	690	690
690	690	690	690	690	690	690	690	690	690	690
440	440	440	440	440	440	690	690	690	690	690
440	440	440	440	440	440	690	690	690	690	690
384	384	560	700	910	910	1120	1330	1610	2100	2100
320	320	400	500	650	650	800	950	1150	1500	1500
320	320	400	500	650	650	800	950	1150	1500	1500
320	320	400	500	650	650	800	950	1150	1500	1500
180	180	250	320	370	370	650	800	1100	1200	1320
63	63	63	80	125	125	160	160	250	250	250
35	35	50	63	80	80	160	160	250	250	250
125	125	125	160	250	250	250	250	250	250	250
63	63	80	80	100	100	200	200	250	250	250

1.15

Contactors

Basic devices up to 170 A

1 DILM7 ... DILM170

				DILM7	DILM9	DILM12	DILM15	DILM17	DILM25	
AC voltage										
AC-1 operation										
Conventional free air thermal current 3 pole 50 - 60 Hz	Open	at 50 °C	I_{th}	A	22	22	22	22	40	45
		at 50 °C	I_{th}	A	21	21	21	21	38	43
		at 55 °C	I_{th}	A	21	21	21	21	37	42
		at 60 °C	I_{th}	A	20	20	20	20	35	40
	Enclosed	I_{th}	A	18	18	18	18	32	36	
Conventional free air thermal current 1 pole	Open	I_{th}	A	50	50	50	50	88	100	
	Enclosed	I_{th}	A	45	45	45	45	80	90	
AC-3 operation										
Rated operational current AC -3 open, 50 - 60 Hz, 3 pole	220/230 V	I_e	A	7	9	12	15.5	18	25	
	240 V	I_e	A	7	9	12	15.5	18	25	
	380/400 V	I_e	A	7	9	12	15.5	18	25	
	415 V	I_e	A	7	9	12	15.5	18	25	
	440 V	I_e	A	7	9	12	15.5	18	25	
	500 V	I_e	A	5	7	10	12.5	18	25	
	660/690 V	I_e	A	4	5	7	9	12	15	
Rated operational power	220/230 V	P	kW	2.2	2.5	3.5	4	5	7.5	
	240 V	P	kW	2.2	3	4	4.6	5.5	8.5	
	380/400 V	P	kW	3	4	5.5	7.5	7.5	11	
	415 V	P	kW	4	5.5	7	8	10	14.5	
	440 V	P	kW	4.5	5.5	7.5	8.4	10.5	15.5	
	500 V	P	kW	3.5	4.5	7	7.5	12	17.5	
	660/690 V	P	kW	3.5	4.5	6.5	7	11	14	
AC-4 operation										
Rated operational current AC-4 open, 50 - 60 Hz, 3 pole	220/230 V	I_e	A	5	6	7	7	10	13	
	240 V	I_e	A	5	6	7	7	10	13	
	380/400 V	I_e	A	5	6	7	7	10	13	
	415 V	I_e	A	5	6	7	7	10	13	
	440 V	I_e	A	5	6	7	7	10	13	
	500 V	I_e	A	4.5	5	6	6	10	13	
	660/690 V	I_e	A	4	4.5	5	5	8	10	
Rated operational power	220/230 V	P	kW	1	1.5	2	2	2.5	3.5	
	240 V	P	kW	1.5	1.6	2.2	2.2	3	4	
	380/400 V	P	kW	2.2	2.5	3	3	4.5	6	
	415 V	P	kW	2.3	2.8	3.4	3.4	5	6.5	
	440 V	P	kW	2.4	3	3.6	3.6	5.5	7	
	500 V	P	kW	2.5	2.8	3.5	3.5	6	8	
	660/690 V	P	kW	2.9	3.6	4.4	4.4	6.5	8.5	
DC voltage										
Operations → Switching of DC current Page 92										
Rated operational current I_e open										
DC-1 operation	60 V	I_e	A	20	20	20	20	35	40	
	110 V	I_e	A	20	20	20	20	35	40	
	220 V	I_e	A	15	15	15	15	35	40	
	440 V	I_e	A	1	1.3	1.3	1.3	2.9	2.9	
DC-3 operation	60 V	I_e	A	20	20	20	20	35	35	
	110 V	I_e	A	20	20	20	20	35	35	
	220 V	I_e	A	1.5	1.5	1.5	1.5	10	10	
	440 V	I_e	A	0.2	0.2	0.2	0.2	0.6	0.6	
DC-5 operation	60 V	I_e	A	20	20	20	20	35	35	
	110 V	I_e	A	20	20	20	20	35	35	
	220 V	I_e	A	1.5	1.5	1.5	1.5	10	10	
	440 V	I_e	A	0.2	0.2	0.2	0.2	0.6	0.6	

DILM32	DILM38	DILM40	DILM50	DILM65	DILM72	DILM80	DILM95	DILM115	DILM150	DILM170
45	45	60	80	98	98	110	130	160	190	225
43	43	57	71	88	88	98	125	142	180	200
42	42	55	68	83	83	94	115	135	170	190
40	40	50	65	80	80	90	110	130	160	185
36	36	45	58	72	72	80	100	115	144	166
100	100	125	162	200	200	225	275	325	400	460
90	90	112	145	180	180	200	250	285	360	415
32	38	40	50	65	72	80	95	115	150	170
32	38	40	50	65	72	80	95	115	150	170
32	38	40	50	65	72	80	95	115	150	170
32	38	40	50	65	72	80	95	115	150	170
32	38	40	50	65	72	80	95	115	150	170
18	22.5	25	32	37	37	65	80	93	100	150
10	11	12.5	15.5	20	22	25	30	37	48	52
11	12	13.5	17	22	25	27.5	32	40	52	57
15	18.5	18.5	22	30	37	37	45	55	75	90
19	20	24	30	39	41	48	57	70	91	100
20	21	25	32	41	44	51	60	75	95	105
23	24	28	36	47	50	58	70	85	110	120
17	21	23	30	35	35	63	75	90	96	140
15	15	18	21	25	25	40	50	55	65	65
15	15	18	21	25	25	40	50	55	65	65
15	15	18	21	25	25	40	50	55	65	65
15	15	18	21	25	25	40	50	55	65	65
15	15	18	21	25	25	40	50	55	65	65
12	12	14	17	20	20	27	37	45	50	50
4	4	5	6	7	7	12	16	17	20	20
4.5	4.5	5.5	6.5	7.5	7.5	13	17	19	22	22
7	7	9	10	12	12	20	26	28	33	33
7.5	7.5	9.5	11	13	13	24	30	33	39	39
8	8	10	12	14	14	25	32	35	41	41
9	9	11	13	16	16	29	36	40	47	47
10	10	12	14	17	17	26	35	43	48	48
40	40	50	60	72	72	110	110	160	160	160
40	40	50	50	72	72	110	110	160	160	160
40	40	45	45	65	65	70	70	90	90	90
2.9	2.9	2.9	2.9	2.9	2.9	4.5	4.5	4.5	4.5	4.5
40	40	50	60	72	72	110	110	160	160	160
40	40	50	50	72	72	110	110	160	160	160
25	25	25	25	35	35	35	35	40	40	40
0.6	0.6	0.6	0.6	0.6	0.6	1	1	1	1	1
40	40	50	60	72	72	110	110	160	160	160
40	40	50	50	72	72	110	110	160	160	160
10	10	25	25	35	35	35	35	40	40	40
0.6	0.6	0.6	0.6	0.6	0.6	1	1	1	1	1

1.15

Contactors

Basic devices up to 170 A

1 DILM7 ... DILM170

			DILM7	DILM9	DILM12	DILM15	DILM17	DILM25
Current heat loss (3 pole)								
Current heat loss at I_{th}	W		3	3	3	3	7.3	9.6
Current heat loss at I_e to AC-3/400 V	W		0.37	0.6	1.1	1.8	1.9	3.8
Impedance per pole	mΩ		2.5	2.5	2.5	2.5	2	2
Magnet systems								
Voltage tolerance								
AC operated	Pick-up	$x U_c$	0.8 - 1.1	0.8 - 1.1	0.8 - 1.1	0.8 - 1.1	0.8 - 1.1	0.8 - 1.1
AC operated	Drop-out	$x U_c$	0.3 - 0.6	0.3 - 0.6	0.3 - 0.6	0.3 - 0.6	0.3 - 0.6	0.3 - 0.6
DC operated ³⁾	Pick-up	$x U_c$	0.8 - 1.1	0.8 - 1.1 ¹⁾	0.8 - 1.1 ¹⁾	0.8 - 1.1 ¹⁾	0.7 - 1.2 ²⁾	0.7 - 1.2 ²⁾
DC operated ³⁾	Drop-out	$x U_c$	0.15 - 0.6	0.15 - 0.6	0.15 - 0.6	0.15 - 0.6	0.15 - 0.6	0.15 - 0.6
Power consumption of the coil in a cold state and $1.0 x U_c$								
50 Hz	Pick-up	VA	24	24	24	24	52	52
50 Hz	Sealing	VA	3.4	3.4	3.4	3.4	7.1	7.1
50 Hz	Sealing	W	1.2	1.2	1.2	1.2	2.1	2.1
60 Hz	Pick-up	VA	30	30	30	30	67	67
60 Hz	Sealing	VA	4.4	4.4	4.4	4.4	8.7	8.7
60 Hz	Sealing	W	1.4	1.4	1.4	1.4	2.6	2.6
50/60 Hz	Pick-up	VA	27	27	27	27	62	62
			25	25	25	25	58	58
50/60 Hz	Sealing	VA	4.2	4.2	4.2	4.2	9.1	9.1
			3.3	3.3	3.3	3.3	6.5	6.5
50/60 Hz	Sealing	W	1.4	1.4	1.4	1.4	2.5	2.5
			1.2	1.2	1.2	1.2	2	2
DC operated	Pick-up	W	3	3	4.5	4.5	12	12
DC operated	Sealing	W	3	3	4.5	4.5	0.5	0.5
Duty factor	% DF		100	100	100	100	100	100
Changeover times at 100 % U_c (recommended values)								
Main contacts								
AC operated	Closing delay	ms	15...21	15...21	15...21	15...21	16...22	16...22
	Opening delay	ms	9...18	9...18	9...18	9...18	8...14	8...14
DC operated	Closing delay	ms	31	31	31	31	47	47
	Opening delay	ms	12	12	12	12	30	30
Arcing time	ms		10	10	10	10	10	10
Permissible residual current when A1 - A2 are actuated from the electronic system (with 0 signal)	mA		—	—	—	—	—	—
Lifespan, mechanical; Coil 50/60 Hz	At 50 Hz		Mechanical lifespan at 50 Hz approx. 30% lower than under → Technical data general					
Electromagnetic compatibility (EMC)								
Emitted interference			To EN 60947-1					
Interference immunity			To EN 60947-1					

Notes

¹⁾ At 24 V DC: 0.7 – 1.3 without auxiliary contact module and at ambient temperature + 40 °C

²⁾ RDC 24 (Umin 24 V DC/Umax 27 V DC)

RDC 60 (Umin 48 V DC/Umax 60 V DC)

RDC 130 (Umin 110 V DC/Umax 130 V DC)

RDC 240 (Umin 200 V DC/Umax 240 V DC)

Example: $U_c = 0.7 \times U_{min} - 1.2 \times U_{max} / U_c = 0.7 \times 24 \text{ V} - 1.2 \times 27 \text{ V DC}$

³⁾ At least: smoothed two-phase bridge rectifier or three-phase rectifier

DILM32	DILM38	DILM40	DILM50	DILM65	DILM72	DILM80	DILM95	DILM115	DILM150	DILM170
12.1	12.1	11.3	19	28.8	28.8	12.2	18.2	20.3	30.7	41.1
6.1	6.1	7.2	11.3	19	23	9.6	13.5	15.9	27	34.7
2	2	1.5	1.5	1.5	1.5	0.5	0.5	0.4	0.4	0.4
0.8 - 1.1	0.8 - 1.1	0.8 - 1.1	0.8 - 1.1	0.8 - 1.1	0.8 - 1.1	0.8 - 1.1	0.8 - 1.1	0.8 - 1.15	0.8 - 1.15	0.8 - 1.15
0.3 - 0.6	0.3 - 0.6	0.3 - 0.6	0.3 - 0.6	0.3 - 0.6	0.3 - 0.6	0.3 - 0.6	0.3 - 0.6	0.25 - 0.6	0.25 - 0.6	0.25 - 0.6
0.7 - 1.2 ²⁾	0.7 - 1.2 ²⁾	0.7 - 1.2 ²⁾	0.7 - 1.2 ²⁾	0.7 - 1.2 ²⁾	0.7 - 1.2 ²⁾	0.7 - 1.2 ²⁾	0.7 - 1.2 ²⁾	0.7 - 1.2 ²⁾	0.7 - 1.2 ²⁾	0.7 - 1.2 ²⁾
0.15 - 0.6	0.15 - 0.6	0.15 - 0.6	0.15 - 0.6	0.15 - 0.6	0.15 - 0.6	0.15 - 0.6	0.15 - 0.6	0.15 - 0.6	0.15 - 0.6	0.15 - 0.6
52	52	149	149	149	149	310	310	180	180	180
7.1	7.1	16	16	16	16	26	26	3.1	3.1	3.1
2.1	2.1	4.3	4.3	4.3	4.3	5.8	5.8	2.1	2.1	2.1
67	67	178	178	178	178	345	345	170	170	170
8.7	8.7	19	19	19	19	30	30	3.1	3.1	3.1
2.6	2.6	5.3	5.3	5.3	5.3	7.1	7.1	2.1	2.1	2.1
62	62	168	168	168	168	372	372	170	170	170
58	58	154	154	154	154	328	328	170	170	170
9.1	9.1	22	22	22	22	37.1	37.1	3.1	3.1	3.1
6.5	6.5	14	14	14	14	22.6	22.6	3.1	3.1	3.1
2.5	2.5	5.3	5.3	5.3	5.3	7.5	7.5	2.1	2.1	2.1
2	2	4.3	4.3	4.3	4.3	6.1	6.1	2.1	2.1	2.1
12	12	24	24	24	24	90	90	149	149	149
0.5	0.5	0.5	0.5	0.5	0.5	1.3	1.3	2.1	2.1	2.1
100	100	100	100	100	100	100	100	100	100	100
16...22	16...22	12...18	12...18	12...18	12...18	14...20	14...20	28...33	28...33	28...33
8...14	8...14	8...13	8...13	8...13	8...13	9...14	9...14	35...41	35...41	35...41
47	47	54	54	54	54	45	45	35	35	35
30	30	24	24	24	24	34	34	30	30	30
10	10	10	10	10	10	15	15	15	15	15
-	-	-	-	-	-	≅1	≅1	≅1	≅1	≅1

Mechanical lifespan at 50 Hz approx. 30% lower than under → Technical data general

To EN 60947-1

To EN 60947-1

1.15

Contactors

Comfort devices and standard devices greater than 170 A

1 DILM185...DILM1600, DILH

Contactors

DILM185A DILM225A DILM250 DILM300A DILM400 DILM500 DILM570

General

Standards	IEC/EN 60947, VDE 0660, UL, CSA								
Lifespan, mechanical									
AC operated	c (contacts)	x 10 ⁶	10	10	10	10	7	7	7
DC operated	c (contacts)	x 10 ⁶	10	10	10	10	7	7	7
Operating frequency, mechanical									
AC operated	Operations/h		3000	3000	3000	3000	2000	2000	2000
DC operated	Operations/h		3000	3000	3000	3000	2000	2000	2000
Maximum operating frequency									
Electrical (Contactor without overload relay)	→ Engineering Page 91								
Climatic proofing									
Damp heat, constant, to IEC 60068-2-78									
Damp heat, cyclic, to IEC 60068-2-30									
Ambient temperature									
Open	°C		-25...60	-25...60	-25...60	-25...60	-25...60	-25...60	-25...60
Enclosed	°C		-25...40	-25...40	-25...40	-25...40	-25...40	-25...40	-25...40
Storage	°C		-40 - 80	-40 - 80	-40 - 80	-40 - 80	-40 - 80	-40 - 80	-40 - 80

Mounting position: AC and DC-actuated

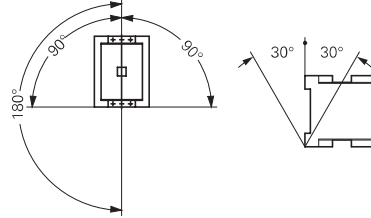

Mechanical shock resistance (IEC/EN 60068-2-27)

Half-sinusoidal shock 10 ms									
Main contacts									
N/O	g		10	10	10	10	10	10	10
Auxiliary contacts									
N/O	g		10	10	10	10	10	10	10
NC	g		8	8	8	8	8	8	8

Protection type IP00 IP00 IP00 IP00 IP00 IP00 IP00 IP00

Protection against direct contact when actuated from front (EN 90274) Finger- and back-of-hand proof with cover or terminal block

Weight									
Weight	kg		3,2	3,2	6,5	6,5	8	8	8

Terminal capacity of main cable									
Flexible with cable lug	mm ²		50 - 185	50 - 185	50 - 240	50 - 240	50 - 240	50 - 240	50 - 240
Stranded with cable lug	mm ²		50 - 185	70 - 185	70 - 240	70 - 240	70 - 240	70 - 240	70 - 240
Solid or stranded	AWG		1/0 - 350	2/0 - 250	2/0 - 500	2/0 - 500	2/0 - 500	2/0 - 500	2/0 - 500
	MCM		MCM	MCM	MCM	MCM	MCM	MCM	MCM
Busbar	Width	mm	32	32	25	25	25	30	30

Main cable connection screw/bolt			M10	M10	M10	M10	M10	M10	M10
Tightening torque	Nm		24	24	24	24	24	24	24

Terminal capacity of control circuit cable								
Solid	mm ²		1 x (0,75 - 2,5) 2 x (0,75 - 2,5)					
Flexible with ferrule	mm ²		1 x (0,75 - 2,5) 2 x (0,75 - 2,5)					
Solid or stranded	AWG		2 x (18 - 12)	2 x (18 - 12)	2 x (18 - 12)	2 x (18 - 12)	2 x (18 - 12)	2 x (18 - 12)

Control circuit cable connection screw/bolt			M3,5	M3,5	M3,5	M3,5	M3,5	M3,5	M3,5
Tightening torque	Nm		1,2	1,2	1,2	1,2	1,2	1,2	1,2

Tools									
Main conductors									
Wrench	mm		16	16	16	16	16	16	16
Auxiliary conductors									
Pozidriv screwdriver	Size		2	2	2	2	2	2	2

DILM580	DILM650	DILM750	DILM820	DILM1000	DILM1600	DILH1400	DILH2000	DILH2200	DILH2600
IEC/EN 60947, VDE 0660, UL, CSA									
5	5	5	5	5	5	5	5	5	5
5	5	5	5	5	5	5	5	5	5
1000	1000	1000	1000	1000	1000	1000	1000	1000	1000
1000	1000	1000	1000	1000	1000	1000	1000	1000	1000
→ Engineering Page 91									
Damp heat, constant, to IEC 60068-2-78									
Damp heat, cyclic, to IEC 60068-2-30									
-25...60	-25...60	-25...60	-25...60	-25...60	-25...60	-25...60	-25...60	-25...60	-25...60
-25...40	-25...40	-25...40	-25...40	-25...40	-25...40	-25...40	-25...40	-25...40	-25...40
-40 - 80	-40 - 80	-40 - 80	-40 - 80	-40 - 80	-40 - 80	-40 - 80	-40 - 80	-40 - 80	-40 - 80
10	10	10	10	10	10	10	10	10	10
10	10	10	10	10	10	10	10	10	10
8	8	8	8	8	8	8	8	8	8
IP00	IP00	IP00	IP00	IP00	IP00	IP00	IP00	IP00	IP00
Finger- and back-of-hand proof with cover or terminal block									
15	15	15	15	15	32	15	32	32	32
50 - 240	50 - 240	50 - 240	50 - 240	50 - 240	-	-	-	-	-
70 - 240	70 - 240	70 - 240	70 - 240	70 - 240	-	-	-	-	-
2/0 - 500 MCM	2/0 - 500 MCM	2/0 - 500 MCM	2/0 - 500 MCM	2/0 - 500 MCM	-	-	-	-	-
50	50	60	60	60	100	80	100	100	100
M10	M10	M12	M12	M12	M12	M12	M12	M12	M12
24	24	35	35	35	35	35	35	35	35
1 x (0.75 - 2.5)									
2 x (0.75 - 2.5)									
1 x (0.75 - 2.5)									
2 x (0.75 - 2.5)									
2 x (18 - 12)	2 x (18 - 12)	2 x (18 - 12)	2 x (18 - 12)	2 x (18 - 12)	2 x (18...12)	2 x (18 - 12)	2 x (18 - 12)	2 x (18 - 12)	2 x (18 - 12)
M3,5	M3,5	M3,5	M3,5	M3,5	M3,5	M3,5	M3,5	M3,5	M3,5
1.2	1.2	1.2	1.2	1.2	1.2	1.2	1.2	1.2	1.2
16	16	18	18	18	18	18	18	18	18
2	2	2	2	2	2	2	2	2	2

1.15

Contactors

Comfort devices and standard devices greater than 170 A

1 DILM185...DILM1600, DILH

			Contactors						
			DILM185A	DILM225A	DILM250	DILM300A	DILM400	DILM500	DILM570
Main contacts									
Rated impulse withstand voltage	U_{imp}	V AC	8000	8000	8000	8000	8000	8000	8000
Overvoltage category/pollution degree			III/3	III/3	III/3	III/3	III/3	III/3	III/3
Rated insulation voltage	U_i	V AC	1000	1000	1000	1000	1000	1000	1000
Rated operating voltage	U_e	V AC	1000	1000	1000	1000	1000	1000	1000
Safe isolation according to EN 61140									
Between coil and contacts		V AC	500	500	500	500	500	500	500
Between the contacts		V AC	500	500	500	500	500	500	500
Making capacity (cos Φ to IEC/EN 60947)		A	2700	2700	3000	3600	5500	5500	6000
Breaking capacity									
220/230 V		A	2250	2250	2500	3000	5000	5000	5800
380/400 V		A	2250	2250	2500	3000	5000	5000	5800
500 V		A	2250	2250	2500	3000	5000	5000	5800
660/690 V		A	2250	2250	2500	3000	5000	5000	5800
1000 V		A	760	760	760	950	950	950	950
Component lifespan			→ Page 87						
Short-circuit rating									
Short-circuit protection rating maximum fuse									
Type "2" coordination									
400 V	gG/gL 500 V	A	250	250	315	315	500	500	500
690 V	gG/gL 690 V	A	250	250	315	315	500	500	500
1000 V	gG/gL 1000 V	A	160	160	160	160	200	200	200
Type "1" coordination									
400 V	gG/gL 500 V	A	400	400	400	400	630	630	800
690 V	gG/gL 690 V	A	315	315	400	400	630	630	630
1000 V	gG/gL 1000 V	A	200	200	200	200	250	250	250
AC voltage									
AC-1 operation									
Conventional thermal current 3 pole 50 - 60 Hz									
Open									
at 40 °C	I_{th}	A	337	356	400	430	612	857	920
at 50 °C	I_{th}	A	301	310	360	385	548	767	821
at 55 °C	I_{th}	A	287	295	340	365	522	731	783
at 60 °C	I_{th}	A	275	285	330	350	500	700	750
Enclosed ¹⁾	I_{th}	A	245	275	300	315	450	650	–
Conventional thermal current, 1-pole									
Open ¹⁾	I_{th}	A	685	707	825	875	1250	1750	1875
Enclosed ¹⁾	I_{th}	A	625	636	742	785	1125	1600	–
AC-3 operation									
Rated operational current AC -3 open, 50 – 60 Hz, 3 pole									
220/230 V	I_e	A	185	225	250	300	400	500	580
240 V	I_e	A	185	225	250	300	400	500	580
380/400 V	I_e	A	185	225	250	300	400	500	580
415 V	I_e	A	185	225	250	300	400	500	580
440 V	I_e	A	185	225	250	300	400	500	580
500 V	I_e	A	185	225	250	300	400	500	500
660/690 V	I_e	A	150	160	250	210	360	360	360
1000 V	I_e	A	76	76	76	95	95	95	95
Rated operational power									
220/230 V	P	kW	55	70	75	90	125	155	185
240 V	P	kW	62	75	85	100	132	170	200
380/400 V	P	kW	90	110	132	160	200	250	315
415 V	P	kW	110	132	148	180	240	300	348
440 V	P	kW	115	138	132	185	200	250	370
500 V	P	kW	132	160	180	215	290	360	360
660/690 V	P	kW	140	150	240	195	344	344	344
1000 V	P	kW	108	108	108	132	132	132	132

Notes

¹⁾ At maximum permissible ambient air temperature

²⁾ To 690 V

DILM580	DILM650	DILM750	DILM820	DILM1000	DILM1600	DILH1400	DILH2000	DILH2200	DILH2600
8000	8000	8000	8000	8000	8000	8000	8000	8000	8000
III/3	III/3	III/3	III/3	III/3	III/3	III/3	III/3	III/3	III/3
1000	1000	1000	1000	1000	1000	1000	1000	1000	1000
1000	1000	1000	1000	1000	1000	1000	1000	1000	1000
500	500	500	500	500	500	500	500	500	500
500	500	500	500	500	500	500	500	500	500
7800	7800	9840	9840	9840	19000	9840	9840	9840	9840
6500	6500	8200	8200	8200	16000	8200	8200	8200	8200
6500	6500	8200	8200	8200	16000	8200	8200	8200	8200
6500	6500	8200	8200	8200	16000	8200	8200	8200	8200
6500	6500	8200	8200	8200	16000	8200	8200	8200	8200
4350	4350	5800	5800	5800	5800	5800	5800	5800	5800
→ Page 87									
630	630	630	630	630	-	-	-	-	-
630	630	630	630	630	-	-	-	-	-
500	500	630	630	630	-	-	-	-	-
1000	1000	1200	1200	1200	-	-	-	-	-
1000	1000	1200	1200	1200	-	-	-	-	-
630	630	800	800	800	-	-	-	-	-
980	1041	1102	1225	1225	2200 ²⁾	1714 ²⁾	2450 ²⁾	2700 ²⁾	3185 ²⁾
876	931	986	1095	1095	1970 ²⁾	1533 ²⁾	2190 ²⁾	2400 ²⁾	2847 ²⁾
836	888	940	1044	1044	1880 ²⁾	1462 ²⁾	2089 ²⁾	2300 ²⁾	2716 ²⁾
800	850	900	1000	1000	1800 ²⁾	1400 ²⁾	2000 ²⁾	2200 ²⁾	2600 ²⁾
-	-	-	-	-	-	-	-	-	-
2000	2125	2250	2500	2500	4500	3500	5000	5500	6500 ²⁾
-	-	-	-	-	-	-	-	-	-
580	650	750	820	1000	1600	-	-	-	-
580	650	750	820	1000	1600	-	-	-	-
580	650	750	820	1000	1600	-	-	-	-
580	650	750	820	1000	1600	-	-	-	-
580	650	750	820	1000	1600	-	-	-	-
580	650	750	820	1000	1600	-	-	-	-
435	435	580	580	750	1200	-	-	-	-
185	205	240	260	315	500	-	-	-	-
200	225	260	285	340	550	-	-	-	-
315	355	400	450	560	900	-	-	-	-
348	390	455	500	610	930	-	-	-	-
370	420	480	450	650	1000	-	-	-	-
420	470	550	600	730	1180	-	-	-	-
560	630	720	750	1000	1600	-	-	-	-
600	600	800	800	1100	1770	-	-	-	-

1.15

Contactors

Comfort devices and standard devices greater than 170 A

1 DILM185...DILM1600, DILH

			Contactors						
			DILM185A	DILM225A	DILM250	DILM300A	DILM400	DILM500	DILM570
AC voltage									
AC-4 operation									
Rated operational current AC-4 open, 50 – 60 Hz, 3 pole									
220/230 V	I_e	A	136	164	200	240	296	360	360
240 V	I_e	A	136	164	200	240	296	360	360
380/400 V	I_e	A	136	164	200	240	296	360	360
415 V	I_e	A	136	164	200	240	296	360	360
440 V	I_e	A	136	164	200	240	296	360	360
500 V	I_e	A	136	164	200	240	296	360	360
660/690 V	I_e	A	110	120	200	170	296	296	296
1000 V	I_e	A	55	55	76	76	95	95	95
Rated operational power									
220/230 V	P	kW	41	51	62	75	92	112	112
240 V	P	kW	45	54	68	82	101	122	122
380/400 V	P	kW	75	90	110	132	160	200	200
415 V	P	kW	80	96	117	142	176	216	216
440 V	P	kW	85	102	125	150	186	229	229
500 V	P	kW	96	116	143	172	214	260	260
660/690 V	P	kW	102	110	189	160	283	344	344
1000 V	P	kW	77	77	108	109	132	132	132
Capacitor operation									
Individual compensation rated operational current I_e of alternating current capacitor									
Open									
To 525 V		A	220	220	220	307	307	307	307
690 V		A	133	133	133	177	177	177	177
Max. peak inrush current		$x I_e$	30	30	30	30	30	30	30
Component lifespan	c (contacts)	$x 10^6$	0.1	0.1	0.1	0.1	0.1	0.1	0.1
Max. operating frequency		Ops/h	200	200	200	200	200	200	200
DC voltage									
Operations → Engineering Page 92									
Rated operational current I_e open									
DC-1 operation									
60 V	I_e	A	300	300	300	400	400	400	400
110 V	I_e	A	300	300	300	400	400	400	400
220 V	I_e	A	300	300	300	400	400	400	400
440 V	I_e	A	11	11	11	11	11	11	11
DC-3 operation									
60 V	I_e	A	300	300	300	400	400	400	400
110 V	I_e	A	300	300	300	400	400	400	400
220 V	I_e	A	300	300	300	400	400	400	400
DC-5 operation									
60 V	I_e	A	300	300	300	400	400	400	400
110 V	I_e	A	300	300	300	400	400	400	400
220 V	I_e	A	300	300	300	400	400	400	400
Current heat loss (3 pole)									
Current heat loss at I_{th}		W	34	45	55	37	58	113	130
Current heat loss at I_e to AC-3/400 V		W	16	23	28	21	37	58	78

DILM580	DILM650	DILM750	DILM820	DILM1000	DILM1600	DILH1400	DILH2000	DILH2200	DILH2600
456	512	576	656	800	1280	–	–	–	–
456	512	576	656	800	1280	–	–	–	–
456	512	576	656	800	1280	–	–	–	–
456	512	576	656	800	1280	–	–	–	–
456	512	576	656	800	1280	–	–	–	–
456	512	576	656	800	1280	–	–	–	–
456	512	576	656	800	1280	–	–	–	–
348	348	464	464	700	1120	–	–	–	–
143	161	181	209	260	430	–	–	–	–
156	176	200	228	280	450	–	–	–	–
250	280	315	355	450	750	–	–	–	–
274	307	346	394	490	770	–	–	–	–
290	326	367	418	520	830	–	–	–	–
330	370	417	474	590	940	–	–	–	–
440	494	556	633	780	1300	–	–	–	–
509	509	678	678	1000	1650	–	–	–	–
463	463	463	463	463	–	–	–	–	–
265	265	265	265	265	–	–	–	–	–
30	30	30	30	30	–	–	–	–	–
0.1	0.1	0.1	0.1	0.1	–	–	–	–	–
200	200	200	200	200	–	–	–	–	–
–	–	–	–	–	–	–	–	–	–
–	–	–	–	–	–	–	–	–	–
–	–	–	–	–	–	–	–	–	–
–	–	–	–	–	–	–	–	–	–
–	–	–	–	–	–	–	–	–	–
–	–	–	–	–	–	–	–	–	–
–	–	–	–	–	–	–	–	–	–
–	–	–	–	–	–	–	–	–	–
–	–	–	–	–	–	–	–	–	–
–	–	–	–	–	–	–	–	–	–
–	–	–	–	–	–	–	–	–	–
–	–	–	–	–	–	–	–	–	–
61	69	78	96	96	155	188	192	232	250
32	41	54	65	96	123	–	–	–	–

1.15

Contactors

Comfort devices and standard devices greater than 170 A

DILM185...DILM1600, DILH

1

Contactors

DILM185A DILM225A DILM250 DILM300A DILM400 DILM500 DILM570

Magnet systems

Voltage tolerance ¹⁾	AC operated	Pick-up	x U _c	0.8 - 1.15	0.8 - 1.15				
	AC operated	Drop-out	x U _c	0.25 - 0.6	0.25 - 0.6				
	DC operated	Pick-up	x U _c	0.7 - 1.2	0.7 - 1.2				
	DC operated	Drop-out	x U _c	0.15 - 0.6	0.15 - 0.6				
Power consumption of the coil in a cold state and 1.0 x U _c	50/60 Hz	Pick-up	VA	210	210	–	–	–	–
	50/60 Hz	Sealing	VA	2.6	2.6	–	–	–	–
	50/60 Hz	Sealing	W	2.6	2.6	–	–	–	–
	DC operated	Pick-up	W	180	180	–	–	–	–
	DC operated	Sealing	W	2.1	2.1	–	–	–	–
Voltage tolerance	Comfort series DILM...	Pick-up	x U _c	–	–	0.7 x U _{c min} - 1.15 x U _{c max}			
	Standard range DILM...-S	Pick-up	x U _c	–	–	0.85 x U _{c min} - 1.1 x U _{c max}			
	Comfort series DILM...	Drop-out	x U _c	–	–	0.2 x U _{c min} - 0.6 x U _{c min}			
	Standard range DILM...-S	Drop-out	x U _c	–	–	0.2 x U _{c min} - 0.4 x U _{c min}			
Power consumption of the coil in a cold state and 1.0 x U _c	Comfort series DILM...	Pick-up	VA	–	–	380 ²⁾	380 ²⁾	450 ²⁾	450 ²⁾
	Comfort series DILM...	Pick-up	W	–	–	250	250	350	350
	Comfort series DILM...	Sealing	VA	–	–	4.3	4.3	4.3	4.3
	Comfort series DILM...	Sealing	W	–	–	3.3	3.3	3.3	3.3
	Standard range DILM...-S	Pick-up	VA	–	–	360 ⁴⁾	360 ⁴⁾	715 ⁴⁾	715 ⁴⁾
	Standard range DILM...-S	Pick-up	W	–	–	325	625	645	645
	Standard range DILM...-S	Sealing	VA	–	–	4.3	4.3	4.3	4.3
	Standard range DILM...-S	Sealing	W	–	–	3.3	3.3	3.3	3.3
Duty factor		% DF	–	–	100	100	100	100	100
Changeover time at 100 % U _c (recommended values), main circuit									
Comfort series DILM...	Closing delay		ms	–	–	< 100	< 80	< 80	< 80
	Opening delay		ms	–	–	< 110	< 110	< 110	< 110
Standard range DILM...-S	Closing delay		ms	< 60	< 60	< 55	< 55	< 55	< 55
	Opening delay		ms	< 40	< 40	< 40	< 40	< 50	< 50
Behavior in limit range and transition area, hold state									
Voltage interruption	(0 - 0.2 x U _{c min}) ≤ 10 ms			–	–	Targeted bridging during this time			
	(0 - 0.2 x U _{c min}) > 10 ms					Drop-out of the contactor			
Voltage drops	(0 - 0.2 x U _{c min}) ≤ 12 ms					Targeted bridging during this time			
	(0.2 - 0.6 x U _{c min}) > 12 ms					Drop-out of the contactor			
Excess voltage	(0.6 - 0.7 x U _{c min})					Contactor remains switched on			
	(1.15 - 1.3 x U _{c max})					Contactor remains switched on			
Pick-up phase	(> 1.3 x U _{c max}) ≤ 3 s					Contactor remains switched on			
	(> 1.3 x U _{c max}) > 3 s					Drop-out of the contactor			
	(0.7 x U _{c min})					Contactor does not switch on			
	(0.7 x U _{c min} - 1.15 x U _{c max})					Contactor switches on safely			
	(> 1.15 x U _{c max})					Contactor switches on safely			
Permissible transitional contact resistance (of external control unit when A11 is actuated)			mΩ	–	–	≤ 500	≤ 500	≤ 500	≤ 500
Permissible residual current (when A11 is actuated from the electronic system in the event of a 0 signal)			mA	–	–	≤ 1	≤ 1	≤ 1	≤ 1
PLC signal level (A3 - A4) to IEC/EN 61131-2 (part no. 2)									
High			V	15	15	15	15	15	–
Low			V	5	5	5	5	5	–

Electromagnetic compatibility (EMC)

Electromagnetic compatibility

This product is designed for operation in industrial environments (environment 2). The use in residential environments (environment 1) could cause electrical interference so that addition suppression must be planned.

Notes

- 1) U_{c min}, U_{c max},
- 2) Control transformer with u_k ≤ 0.6
- 3) Control transformer with u_k ≤ 0.7
- 4) u_k ≤ 10 %

DILM580	DILM650	DILM750	DILM820	DILM1000	DILM1600	DILH1400	DILH2000	DILH2200	DILH2600
–	–	–	–	–	–	–	–	–	–
–	–	–	–	–	–	–	–	–	–
–	–	–	–	–	–	–	–	–	–
–	–	–	–	–	–	–	–	–	–
–	–	–	–	–	–	–	–	–	–
–	–	–	–	–	–	–	–	–	–
–	–	–	–	–	–	–	–	–	–
0.7 x U _{c min} - 1.15 x U _{c max}									
0.85 x U _{c min} - 1.1 x U _{c max}									
0.2 x U _{c min} - 0.6 x U _{c min}									
0.2 x U _{c min} - 0.4 x U _{c min}									
800 ³⁾	800 ³⁾	800 ³⁾	800 ³⁾	800 ³⁾	1600 ³⁾	800 ³⁾	1600 ³⁾	1600 ³⁾	–
700	700	700	700	700	1400	700	1400	1400	–
7.5	7.5	7.5	7.5	7.5	15	7.5	15	15	–
6.5	6.5	6.5	6.5	6.5	13	6.5	13	13	–
–	–	–	–	–	–	–	–	–	–
–	–	–	–	–	–	–	–	–	–
–	–	–	–	–	–	–	–	–	–
–	–	–	–	–	–	–	–	–	–
100	100	100	100	100	100	100	100	100	100
< 70	< 70	< 70	< 70	< 70	< 70	< 70	< 70	< 70	–
< 110	< 110	< 110	< 110	< 110	< 40	< 40	< 40	< 40	–
–	–	–	–	–	–	–	–	–	–
–	–	–	–	–	–	–	–	–	–
–	–	–	–	–	–	–	–	–	–
Targeted bridging during this time									
Drop-out of the contactor									
Targeted bridging during this time									
Drop-out of the contactor									
Contactor remains switched on									
Contactor remains switched on									
Contactor remains switched on									
Drop-out of the contactor									
Contactor does not switch on									
Contactor switches on safely									
Contactor switches on safely									
≅ 500	≅ 500	≅ 500	≅ 500	≅ 500	≅ 500	≅ 500	≅ 500	≅ 500	≅ 500
≅ 1	≅ 1	≅ 1	≅ 1	≅ 1	≅ 1	≅ 1	≅ 1	≅ 1	≅ 1
–	–	–	–	–	–	–	–	–	–
15	15	15	15	15	15	15	15	15	15
5	5	5	5	5	5	5	5	5	5

This product is designed for operation in industrial environments (environment 2). The use in residential environments (environment 1) could cause electrical interference so that addition suppression must be planned.

1.15

Contactors

Basic devices up to 200 A, 4 pole

DILMP20 ... DILMP200

1

DILMP20 **DILMP32** **DILMP63** **DILMP125**
DILMP45 **DILMP80** **DILMP160**
DILMP200

General

Standards	IEC/EN 60947, VDE 0660, UL, CSA			
Lifespan, mechanical				
AC operated	c (contacts)	x 10 ⁶	10	
DC operated	c (contacts)	x 10 ⁶	10	
Operating frequency, mechanical				
Mechanical, AC operated	Operations/h		5000	3600
DC operated	Operations/h		5000	3600
Maximum operating frequency				
Electrical (Contactor without overload relay)	600			
Climatic proofing				
Damp heat, constant, to IEC 60068-2-3				
Damp heat, cyclic, to IEC 60068-2-30				
Ambient temperature				
Open	°C	-25...60		
Enclosed	°C	-25...40		
Storage	°C	-40 - 80		

Mounting position AC- and DC operated

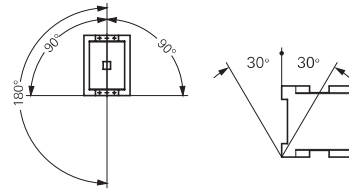

Mechanical shock resistance (IEC/EN 60068-2-27)

Half-sinusoidal shock 10 ms				
Main contacts				
N/O	g	10		
Auxiliary contacts				
N/O	g	7		
NC	g	5		

Protection type	IP20	IP00		
With accessories	–	IP20		
Protection against direct contact when actuated from front (EN 50274)	Finger- and back-of-hand proof			

Terminal type, screw connection

Terminal capacity of main cable					
Solid	mm ²	1 x (0.75 - 4)	1 x (0.75 - 16)	1 x (2.5 - 16)	–
		2 x (0.75 - 2.5)	2 x (0.75 - 10)	2 x (2.5 - 16)	
Flexible with ferrule	mm ²	1 x (0.75 - 2.5)	1 x (0.75 - 16)	1 x (2.5 - 35)	1 x (10 - 95)
		2 x (0.75 - 2.5)	2 x (0.75 - 10)	2 x (2.5 - 25)	2 x (10 - 70)
Stranded	mm ²	–	1 x 16	1 x (16 - 50)	1 x (16 - 120)
				2 x (16 - 35)	2 x (16 - 95)
Solid or stranded	AWG	18 - 14	18 - 6	12 - 2	8 - 250MCM
Flat conductor	Number of layers x width x thickness	mm	–	2 x (6 x 9 x 0.8)	2 x (6 x 16 x 0.8)

Terminal capacity of control circuit cable					
Solid	mm ²	1 x (0.75 - 4)	1 x (0.75 - 4)	1 x (0.75 - 4)	1 x (0.75 - 4)
		2 x (0.75 - 2.5)	2 x (0.75 - 2.5)	2 x (0.75 - 4)	2 x (0.75 - 4)
Flexible with ferrule	mm ²	1 x (0.75 - 2.5)	1 x (0.75 - 2.5)	1 x (0.75 - 2.5)	1 x (0.75 - 2.5)
		2 x (0.75 - 2.5)	2 x (0.75 - 2.5)	2 x (0.75 - 2.5)	2 x (0.75 - 2.5)
Solid or stranded	AWG	18 - 14	18 - 14	18 - 14	18 - 14

Main cable connection screw/bolt	M3,5	M5	M6	M10
Tightening torque	Nm	1.2	3	3.3
Control circuit cable connection screw/bolt	M3,5	M3,5	M3,5	M3,5
Tightening torque	Nm	1.2	1.2	1.2

Tools

Main conductors					
Pozidriv screwdriver	Size	2	2	2	–
Internal hexagon	SW	mm	–	–	5
Flat-blade screwdriver	mm	0.8 x 5.5	0.8 x 5.5	0.8 x 5.5	–
		1 x 6	1 x 6	1 x 6	
Auxiliary conductors					
Pozidriv screwdriver	Size	2	2	2	2
Flat-blade screwdriver	mm	0.8 x 5.5	0.8 x 5.5	0.8 x 5.5	0.8 x 5.5
		1 x 6	1 x 6	1 x 6	1 x 6

DILMP20 ... DILMP200

1

			DILMP20	DILMP32 DILMP45	DILMP63 DILMP80	DILMP125 DILMP160	DILMP200				
Main contacts											
Rated impulse withstand voltage	U_{imp}	V AC	8000								
Overvoltage category/pollution degree			III/3								
Rated insulation voltage	U_i	V AC	690								
Rated operating voltage	U_e	V AC	690								
Safe isolation according to EN 61140											
Between coil and contacts		V AC	400	440							
Between the contacts		V AC	400	440							
Making capacity (cos ϕ to IEC/EN 60947)	To 690 V	A	144	238	350	560	700	1120	1330	1800	
Breaking capacity											
220/230 V		A	120	180	250	400	500	800	950	1150	
380/400 V		A	120	180	250	400	500	800	950	1150	
500 V		A	100	180	250	400	500	800	950	1150	
660/690 V		A	70	120	144	250	296	650	750	800	
Short-circuit rating											
Short-circuit protection rating maximum fuse											
Type "2" coordination											
400 V	gG/gL 500 V	A	20	35	35	63	80	160	160	250	
690 V	gG/gL 690 V	A	20	35	35	50	63	160	160	200	
Type "1" coordination											
400 V	gG/gL 500 V	A	35	63	100	125	160	250	250	250	
690 V	gG/gL 690 V	A	25	50	50	80	80	200	200	200	
AC voltage											
AC-1 operation											
Conventional thermal current 3 pole 50 - 60 Hz											
Open	at 40 °C	I_{th}	A	22	32	45	63	80	125	160	200
	at 50 °C	I_{th}	A	21	30	41	60	76	116	150	188
	at 60 °C	I_{th}	A	20	28	39	54	69	108	138	172
Enclosed		I_{th}	A	18	27	36	50	64	100	128	160
Conventional thermal current, 1 pole											
Open		I_{th}	A	60	84	117	162	207	325	415	516
Enclosed		I_{th}	A	54	76	105	146	186	292	373	464
Rated operational power											
220/230 V		P	kW	8	12	16	23	29	45	58	72
240 V		P	kW	9	13	18	25	32	49	63	79
380/400 V		P	kW	14	20	28	39	50	78	100	125
415 V		P	kW	15	22	31	43	55	85	109	137
440 V		P	kW	16	23	33	46	58	90	116	145
500 V		P	kW	18	26	37	52	66	103	132	165
690 V		P	kW	24	35	49	68	87	136	174	217
AC-3 operation											
Rated operational current AC -3 open, 50 – 60 Hz, 3 pole											
220/230 V		I_e	A	12	18	25	40	50	80	95	115
240 V		I_e	A	12	18	25	40	50	80	95	115
380/400 V		I_e	A	12	18	25	40	50	80	95	115
415 V		I_e	A	12	18	25	40	50	80	95	115
440 V		I_e	A	12	18	25	40	50	80	95	115
500 V		I_e	A	10	18	25	40	50	80	95	115
660/690 V		I_e	A	7	12	15	25	32	65	80	93
Rated operational power											
220/230 V		P	kW	3.5	5	7.5	12.5	15.5	25	30	37
240 V		P	kW	4	5.5	8.5	13.5	17	27.5	33	40
380/400 V		P	kW	5.5	7.5	11	18.5	22	37	45	55
415 V		P	kW	7	10	14.5	24	30	48	57	70
440 V		P	kW	7.5	10.5	15.5	25	32	51	60	75
500 V		P	kW	7	12	17.5	28	36	58	70	85
660/690 V		P	kW	6.5	11	14	23	30	63	75	90

1.15

Contactors

Basic devices up to 200 A, 4 pole

1 DILMP20 ... DILMP200

			DILMP20	DILMP32	DILMP63	DILMP125	DILMP45	DILMP80	DILMP160	DILMP200
DC voltage										
Rated operational current $I_{e \text{ open}}$										
DC-1 operation										
60 V	I_e	A	22	32	45	63	80	125	160	200
110 V	I_e	A	22	32	45	63	80	125	160	200
220 V	I_e	A	6	32	45	63	80	125	160	200
440 V	I_e	A	1.3	3	3	5	5	10	10	10
DC-3 operation										
60 V	I_e	A	20	32	45	63	80	125	160	200
110 V	I_e	A	20	32	45	63	80	125	160	200
220 V	I_e	A	1.5	32	45	63	80	125	160	200
440 V	I_e	A	0.2	6	6	8	8	9	9	9
DC-5 operation										
60 V	I_e	A	20	32	45	63	80	125	160	200
110 V	I_e	A	20	25	32	50	80	125	160	200
220 V	I_e	A	1.5	15	22	38	70	100	125	150
440 V	I_e	A	0.2	4	4	8	8	8	8	8
Current heat loss (3 pole)										
Current heat loss at I_{th}										
		W	4.7	8.2	12	16	23	29	46	60
Impedance per pole										
		mΩ	2.5	2	1.5	1	0.7	0.6	0.6	0.5
Magnet systems										
Voltage tolerance										
AC operated 50 Hz	Pick-up	$x U_c$	0.8 - 1.1	0.8 - 1.1	0.8 - 1.1	0.8 - 1.1	0.8 - 1.1	0.8 - 1.1	0.8 - 1.1	0.8 - 1.1
AC operated 50/60 Hz		$x U_c$	0.8 - 1.1	0.85 - 1.1	0.85 - 1.1	0.85 - 1.1	0.85 - 1.1	0.85 - 1.1	0.85 - 1.1	0.85 - 1.1
AC operated	Drop-out	$x U_c$	0.4 - 0.6	0.4 - 0.6	0.4 - 0.6	0.4 - 0.6	0.4 - 0.6	0.4 - 0.6	0.4 - 0.6	0.4 - 0.6
DC operated ¹⁾	Pick-up	$x U_c$	0.8 - 1.1	0.7 - 1.2	0.7 - 1.2	0.7 - 1.2	0.7 - 1.2	0.7 - 1.2	0.7 - 1.2	0.7 - 1.2
DC operated ¹⁾	Drop-out	$x U_c$	0.2 - 0.6	0.2 - 0.6	0.2 - 0.6	0.2 - 0.6	0.2 - 0.6	0.2 - 0.6	0.2 - 0.6	0.2 - 0.6
Power consumption of the coil in a cold state and $1.0 \times U_c$										
AC operated 50/60 Hz	Pick-up	VA	24	50	150	180	180	180	180	180
AC operated 50/60 Hz	Pick-up	W	19	40	95	150	150	150	150	150
AC operated 50/60 Hz	Sealing	VA	4	8	16	3.1	3.1	3.1	3.1	3.1
AC operated 50/60 Hz	Sealing	W	1.2	2.4	4	2.1	2.1	2.1	2.1	2.1
DC operated ¹⁾	Pick-up	W	4.5	12	24	149	149	149	149	149
DC operated ¹⁾	Sealing	W	4.5	0.5	0.5	2.1	2.1	2.1	2.1	2.1
Duty factor										
		% DF	100	100	100	100	100	100	100	100
Changeover times at 100 % U_c (recommended values)										
Main contacts										
AC operated										
	Closing delay	ms	15...21	16...22	12...18	28...33	28...33	28...33	28...33	28...33
	Opening delay	ms	9...18	8...14	8...13	35...41	35...41	35...41	35...41	35...41
DC operated ¹⁾										
	Closing delay	ms	31	47	54	35	35	35	35	35
	Opening delay	ms	12	30	24	30	30	30	30	30
Arcing time										
		ms	10	10	10	15	15	15	15	15
Permissible residual current when A1 - A2 are actuated from the electronic system (with 0 signal)										
		mA	≅ 1	≅ 1	≅ 1	≅ 1	≅ 1	≅ 1	≅ 1	≅ 1

Notes

¹⁾ At least double-pulse bridge rectifier

DILK

1

			DILK12	DILK20	DILK25	DILK33	DILK50
General							
Standards			IEC/EN 60947, VDE 0660				
Ambient temperature							
Open	°C		-25...60	-25...60	-25...60	-25...60	-25...60
Enclosed	°C		-25...40	-25...40	-25...40	-25...40	-25...40
Mounting position							
Protection type			IP00	IP00	IP00	IP00	IP00
Protection against direct contact when actuated from front (EN 50274)			Finger- and back-of-hand proof				
Weight basic device							
AC operated	kg		0.55	0.55	0.55	1	1
Terminal capacity of main cable							
Solid	mm ²		1 x (0.75 - 16)	1 x (0.75 - 16)	1 x (0.75 - 16)	1 x (2.5 - 16)	1 x (2.5 - 16)
Flexible with ferrule	mm ²		1 x (0.75 - 16)	1 x (0.75 - 16)	1 x (0.75 - 16)	1 x (2.5 - 35)	1 x (2.5 - 35)
Stranded	mm ²		1 x 16	1 x 16	1 x 16	1 x (16 - 50)	1 x (16 - 50)
Solid or stranded	AWG		18 - 16	18 - 6	18 - 6	12 - 2	12 - 2
Flat conductor	Number of layers x width x thickness	mm	-	-	-	1 x (6 x 9 x 0.8)	1 x (6 x 9 x 0.8)
Group compensation							
60 Hz							
230 V	kvar		7.5	11	15	20	25
400 V	kvar		12.5	20	25	33.3	50
525 V	kvar		16.7	25	33.3	40	65
690 V	kvar		20	33.3	40	55	85
50/60 Hz							
Open							
230 V	I _e	A	18	29	38	50	72
400 V	I _e	A	18	29	38	50	72
525 V	I _e	A	18	29	38	50	72
690 V	I _e	A	18	29	38	50	72
Enclosed							
230 V	I _e	A	16	26	34	45	65
400 V	I _e	A	16	26	34	45	65
525 V	I _e	A	16	26	34	45	65
690 V	I _e	A	16	26	34	45	65
Making capacity (i-peak value) without damping			x I _e	180	180	180	180
Component lifespan			c (contacts) x 10 ⁶	0.15	0.15	0.15	0.15
Maximum operating frequency			Ops/h	120	120	120	120

1.15

Contactors

Contactor for capacitors

1 DILK

			DILK12	DILK20	DILK25	DILK33	DILK50
Magnet systems							
Voltage tolerance							
AC operated	Pick-up	x U _c	0.8 - 1.1	0.8 - 1.1	0.8 - 1.1	0.8 - 1.15	0.8 - 1.15
AC operated	Drop-out	x U _c	0.3 - 0.6	0.3 - 0.6	0.3 - 0.6	0.3 - 0.6	0.3 - 0.6
Power consumption of the coil in a cold state and 1.0 x U _c							
50 Hz	Pick-up	VA	58	58	58	45	45
50 Hz	Sealing	VA	7.6	7.6	7.6	1.5	1.5
50 Hz	Sealing	W	2.3	2.3	2.3	1.5	1.5
60 Hz	Pick-up	VA	71	71	71	45	45
60 Hz	Sealing	VA	9.3	9.3	9.3	1.5	1.5
60 Hz	Sealing	W	2.8	2.8	2.8	1.5	1.5
50/60 Hz	Pick-up	VA	65	65	65	45	45
			59	59	59	45	45
50/60 Hz	Sealing	VA	9.6	9.6	9.6	1.5	1.5
			7	7	7	1.5	1.5
50/60 Hz	Sealing	W	2.7	2.7	2.7	1.5	1.5
			2.2	2.2	2.2	1.5	1.5
Duty factor		% DF	100	100	100	100	100
Changeover times at 100 % U _c (recommended values)							
Main contacts							
AC operated							
	Closing delay	ms	16...22	16...22	16...22	50	50
	Opening delay	ms	8...14	8...14	8...14	40	40
Arcing time		ms	10	10	10	10	10
Electromagnetic compatibility (EMC)							
Emitted interference			To EN 60947-1	To EN 60947-1	To EN 60947-1	To EN 60947-1	To EN 60947-1
Interference immunity			To EN 60947-1	To EN 60947-1	To EN 60947-1	To EN 60947-1	To EN 60947-1
Further technical data							
As per contactor	DIL		M17	M25	M32	M50	M65

DILL

1

				DILL12	DILL18	DILL20
General						
Standards				IEC/EN 60947, VDE 0660, UL, CSA		
Lifespan, mechanical						
AC operated		c (contacts)	x 10 ⁶	1	1	1
Operating frequency, mechanical						
Mechanical, AC operated		Operations/h		60	60	60
Maximum operating frequency						
Electrical		Operations/h		60	60	60
Climatic proofing				Damp heat, constant, to IEC 60068-2-78; Damp heat, cyclic, to IEC 60068-2-30		
Ambient temperature	Open	°C		-25...60	-25...60	-25...60
	Enclosed	°C		-25...40	-25...40	-25...40
	Storage	°C		-40 - 80	-40 - 80	-40 - 80
Mounting position						
Mechanical shock resistance (IEC/EN 60068-2-27)						
Half-sinusoidal shock 10 ms				6.9	6.9	6.9
Protection type				IP00	IP00	IP00
Weight						
AC operated		kg		0.42	0.42	0.42
Main contacts						
Rated impulse withstand voltage		U _{imp}	V AC	8000	8000	8000
Overvoltage category/pollution degree				III/3	III/3	III/3
Rated insulation voltage		U _i	V AC	690	690	690
Rated operating voltage		U _e	V AC	690	690	690
Making capacity			A	238	350	550
Breaking capacity		380/400 V	A	170	250	320
Lifespan, electrical		c (contacts)		10000	10000	10000
Short-circuit protection rating maximum fuse						
400 V		gG/gL 500 V	A	63	100	125
AC voltage						
AC-1 operation						
Conventional thermal current						
at 40 °C		I _{th}	A	27	40	45
at 60 °C		I _{th}	A	24	35	40
230 V		I _e	A	12	18	20
400 V		I _e	A	12	18	20
AC-1 operation						
220/230 V		I _e	A	14	21	27
400 V		I _e	A	14	21	27
Electric lamps						
Filament bulbs			A	14	21	27
Mercury blended lamps			A	12	16	23
Fluorescent lamp load						
Conventional reactor starter connection			A	20	26	35
Duo circuit			A	20	26	35
Electronic upstream devices			A	12	18	20
High-pressure mercury vapour lamps			A	12	18	20
Metal-halide lamps			A	12	18	20
High-pressure sodium lamps			A	12	18	20
Low-pressure sodium lamps			A	7.5	10	12
Maximum permissible compensation capacitance			µF	470	470	470
Further technical data						
As per contactor		DIL		M17	M25	M32

1.15

Contactors

Contactors up to 150 A with electronic actuation

1 DILMF

		DILMF8	DILMF11	DILMF14	DILMF17		
General							
Mounting position							
AC voltage							
AC-3 operation							
Rated operational current AC-3 open, 50 – 60 Hz, 3 pole	220/230 V	I_e	A	7	9	12	18
	240 V	I_e	A	7	9	12	18
	380/400 V	I_e	A	7	9	12	18
	415 V	I_e	A	7	9	12	18
	440 V	I_e	A	7	9	12	18
	500 V	I_e	A	5	7	10	18
	660/690 V	I_e	A	4	5	7	12
	Rated operational power	220/230 V	P	kW	2.2	2.5	3.5
240 V		P	kW	2.2	3	4	5.5
380/400 V		P	kW	3	4	5.5	7.5
415 V		P	kW	4	5.5	7	10
440 V		P	kW	4.5	5.5	7.5	10.5
500 V		P	kW	3.5	4.5	7	12
660/690 V		P	kW	3.5	4.5	6.5	11
AC-4 operation							
Rated operational current AC-4 open, 50 - 60 Hz, 3 pole	220/230 V	I_e	A	5	6	7	10
	240 V	I_e	A	5	6	7	10
	380/400 V	I_e	A	5	6	7	10
	415 V	I_e	A	5	6	7	10
	440 V	I_e	A	5	6	7	10
	500 V	I_e	A	4.5	5	6	10
	660/690 V	I_e	A	4	4.5	5	8
Rated operational power	220/230 V	P	kW	1	1.5	2	2.5
	240 V	P	kW	1.5	1.6	2.2	3
	380/400 V	P	kW	2.2	2.5	3	4.5
	415 V	P	kW	2.3	2.8	3.4	5
	440 V	P	kW	2.4	3	3.6	5.5
	500 V	P	kW	2.5	2.8	3.5	6
	660/690 V	P	kW	2.9	3.6	4.4	6.5
Current heat loss (3 pole)							
Current heat loss at I_{th}			W	2.4	2.4	2.4	7.3
Current heat loss at I_e to AC-3/400 V			W	0.3	0.6	1	1.9
Magnet systems							
Voltage tolerance	AC operated	Pick-up	$x U_c$	0.8 - 1.15	0.8 - 1.15	0.8 - 1.15	0.8 - 1.15
	AC operated	Drop-out	$x U_c$	0.2 - 0.5	0.2 - 0.5	0.2 - 0.5	0.2 - 0.5
Power consumption of the coil in a cold state and $1.0 \times U_c$	Electronic actuation	Pick-up	VA	14	14	14	14
	Electronic actuation	Sealing	VA	0.7	0.7	0.7	0.7
	Electronic actuation	Sealing	W	0.7	0.7	0.7	0.7
Duty factor		% DF		100	100	100	100
Switching times	Closing delay	ms		40	40	40	40
	Opening delay	ms		45	45	45	45
suitable according to				SEMI F47	SEMI F47	SEMI F47	SEMI F47
Electromagnetic compatibility (EMC)							
Emitted interference				To EN 60947-1			
Interference immunity				To EN 60947-1			
Further technical data							
As per contactor		DIL	M7	M9	M12	M17	
Terminal type							
As per contactor		DIL	M17	M17	M17	M17	

DILMF25 DILMF32 DILMF40 DILMF50 DILMF65 DILMF80 DILMF95 DILMF115 DILMF150

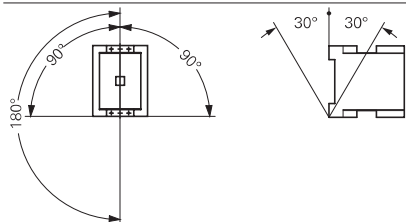

25	32	40	50	65	80	95	115	150
25	32	40	50	65	80	95	115	150
25	32	40	50	65	80	95	115	150
25	32	40	50	65	80	95	115	150
25	32	40	50	65	80	95	115	150
25	32	40	50	65	80	95	115	150
15	18	25	32	37	65	80	93	100
7.5	10	12.5	15.5	20	25	30	37	48
8.5	11	13.5	17	22	27.5	4	40	52
11	15	18.5	22	30	37	45	55	75
14.5	19	24	30	39	48	57	70	91
15.5	20	25	32	41	51	60	75	95
17.5	23	28	36	47	58	70	85	110
14	17	23	30	35	63	75	90	96
13	15	18	21	25	40	50	55	65
13	15	18	21	25	40	50	55	65
13	15	18	21	25	40	50	55	65
13	15	18	21	25	40	50	55	65
13	15	18	21	25	40	50	55	65
10	12	14	17	20	27	37	45	50
3.5	4	5	6	7	12	16	17	20
4	4.5	5.5	6.5	7.5	13	17	19	22
6	7	9	10	12	20	26	28	33
6.5	7.5	9.5	11	13	24	30	33	39
7	8	10	12	14	25	32	35	41
8	9	11	13	16	29	36	40	47
8.5	10	12	14	17	26	35	43	48
9.6	12.1	11.3	19	28.8	14.6	21.8	30.4	46.1
3.8	6.1	7.2	11.3	19	11.5	16.2	23.8	40.5
0.8 - 1.15	0.8 - 1.15	0.8 - 1.15	0.8 - 1.15	0.8 - 1.15	0.8 - 1.15	0.8 - 1.15	0.8 - 1.15	0.8 - 1.15
0.2 - 0.5	0.2 - 0.5	0.2 - 0.5	0.2 - 0.5	0.2 - 0.5	0.2 - 0.5	0.2 - 0.5	0.2 - 0.5	0.2 - 0.5
14	14	45	45	45	75	75	180	180
0.7	0.7	1.5	1.5	1.5	2	2	3.1	3.1
0.7	0.7	1.5	1.5	1.5	2	2	2.1	2.1
100	100	100	100	100	100	100	100	100
40	40	50	50	50	55	55	40	40
45	45	45	45	45	40	40	40	40
SEMI F47	SEMI F47	SEMI F47	SEMI F47	SEMI F47	SEMI F47	SEMI F47	SEMI F47	SEMI F47
To EN 60947-1								
To EN 60947-1								
M25	M32	M40	M50	M65	M80	M95	M115	M150
M25	M32	M40	M50	M65	M80	M95	M115	M150

1.15

Contactors

Auxiliary contact modules

1 DILM..., DILA...

			DILM7-... - DILM38-...	DILA- XHI(C)...(-S)	DILM32- XHI(C)...(-S)	DILM150- XHI...	DILM1000-XHI... DILM820-XHI...
Auxiliary contact							
Interlocked opposing contacts within an auxiliary contact module (to IEC 60947-5-1 Annex L) ¹⁾			-	Yes	Yes	Yes	Yes
Normally closed (not late-normally closed) suitable as a mirror contact (to IEC/EN 60947-4-1, Annex F)			DILM7 - DILM38	DILM7 - DILM38	DILM7 - DILM38	DILM40 - DILM170	DILM40 - DILM225A DILM250 - DILM1000
Rated impulse withstand voltage	U_{imp}	V AC	6000	6000	6000	6000	6000
Overtoltage category/pollution degree			III/3	III/3	III/3	III/3	III/3
Rated insulation voltage	U_i	V AC	690	690	690	690	690
Rated operating voltage	U_e	V AC	500	500	500	500	500
Safe isolation according to EN 61140							
Between coil and auxiliary contacts		V AC	400	400	400	440	440
Between the auxiliary contacts		V AC	400	400	400	440	440
Rated operational current							
AC-15							
230 V	I_e	A	4	4	4	4	4
380/415 V	I_e	A	4	4	4	4	4
500 V	I_e	A	1.5	—	1.5	1.5	1.5
DC L/R ≤ 15 ms ²⁾							
24 V	I_e	A	10	10	10	10	10
60 V	I_e	A	6	6	6	6	6
110 V	I_e	A	3	3	3	3	3
220 V	I_e	A	1	1	1	1	1
DC-13 (6xP)							
Contacts in series:							
3	24 V	A	2.5	2.5	2.5	—	—
3	60 V	A	1	1	1	—	—
3	110 V	A	0.5	0.5	0.5	—	—
3	220 V	A	0.25	0.25	0.25	—	—
Conventional thermal current	I_{th}	A	10	16	16	16	10
Control circuit reliability (at $U_e = 24$ V DC, $U_{min} = 17$ V, $I_{min} = 5.4$ mA)			Fault probability	λ	< 10^{-8} , < 1 one failure in 100 million operations		
Component lifespan							
at $U_e = 230$ V, AC-15, 3 A		c (contacts)	$\times 10^6$	1.3	1.3	1.3	1.3
Short-circuit rating without welding							
Max. fuse		A gG/gL	10	10	10	16	16

Notes

¹⁾ Not with DIL...-XHIV and DIL...-XHICV.

²⁾ Switch-on and switch-off conditions based on DC-13, time constant as specified.

P1SIL...M, DILM...-XP1

1

			P1DILEM DILM12-XP1	DILM32-XP1	DILM65-XP1	DILM150-XP1	DILM185-XP1
Parallel connector							
Terminal capacity							
Solid		mm ²	1 - 16	16	16	—	—
Flexible with ferrule		mm ²	1 x (0.5 - 25) 2 x (0.5 - 16)	1 x (16 - 35)	1 x (16 - 120)	—	—
Stranded		mm ²	1 x (0.5 - 25) 2 x (0.5 - 16)	1 x (16 - 50)	1 x (16 - 120)	1 x (35 - 300) 2 x (35 - 120)	—
Flat conductor	Number of layers x width x thickness	mm	6 x 9 x 0.8	—	—	2 x (11 x 21 x 1)	1 x (6 x 16 x 0.8) 2 x (20 x 32 x 0.5) 2 x (11 x 21 x 1)
Tightening torque		Nm	4	4	14	14	6
Terminal capacity of control circuit cable							
Solid		mm ²	—	—	—	—	1 x (0.75 - 4) 2 x (0.75 - 4)
Flexible with ferrule		mm ²	—	—	—	—	1 x (0.75 - 2.5) 2 x (0.75 - 2.5)
Tools							
Pozidriv screwdriver		Size	2	2	—	—	—
Internal hexagon	SW	mm	—	—	5	6	5
Conventional thermal current							
3 pole	I _{th}	A	50	100	180	400	700
4 pole	I _{th}	A	60	—	—	—	—

1.16

Contactors

Minicontactor relay, contactor combination

Dimensions

1 Mini contactor relays

DILER...(-C)
DILER...-G(-C)



DILER...(-C) + ...DILE(-C)
DILER...-G(-C) + ...DILE(-C)

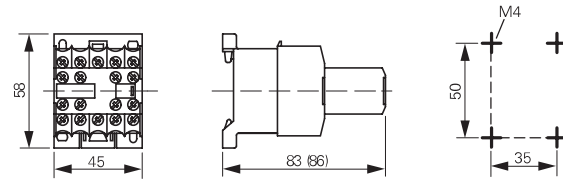

DILEEM..., DILEM...(-C), DILEM-12-...
DILEEM...-G, DILEM...-G(-C), DILEM-12-...-G

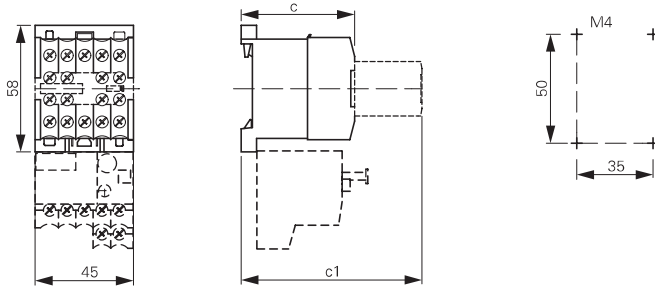

Part no.	c	c1
DILE(E)M...(-G)	52	83
DILE(E)M...-G(-C)	54	86

DILER... + HDILE
DILER...-G + HDILE



Suppressor circuit

RCDILE...
VGDILE

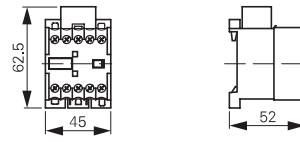

2DILE... + MVDILE
2DILE...-G + MVDILE

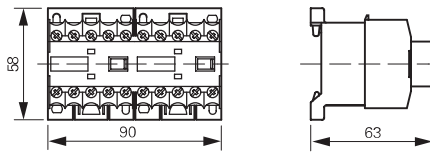

2DILE... + MVDILE + ...DILE
2DILE...-G + MVDILE + ...DILE

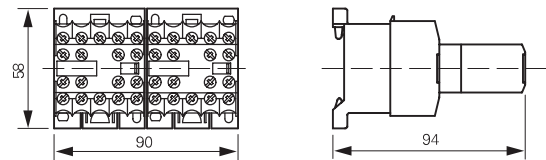

Rsrrotcatnocgnisreve

DIULEM

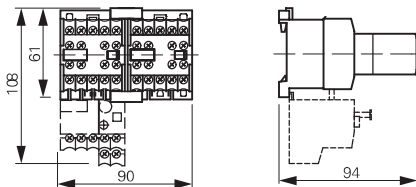

Star-delta contactors

SDAINLEM

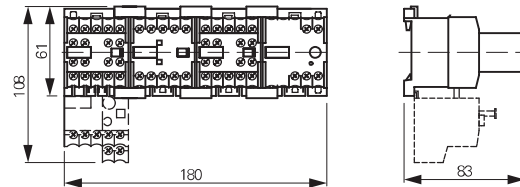

DILER... + TDDILE24

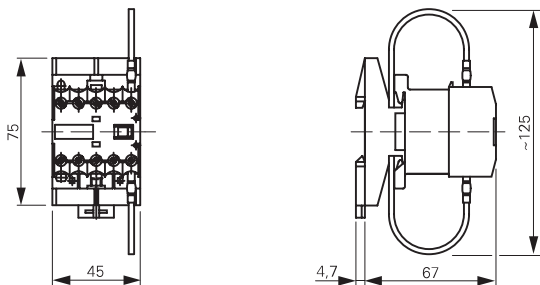

Parallel connector

P1DILEM

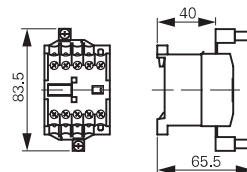

Contactor with auxiliary contact module

DILM7...DILM15
DILA...

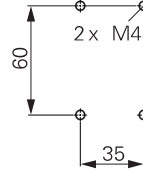
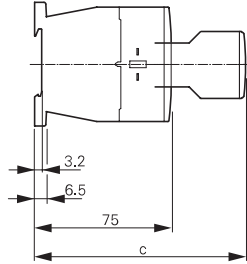
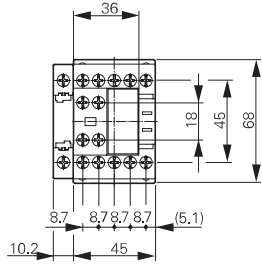

Part no.	c
DILM32-XHI	117
DILA-XHI	117
DILA-XHI...T	125

DILMC7...DILMC15
DILAC...
DILA-XHIC...

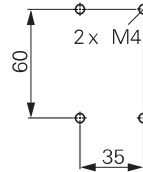
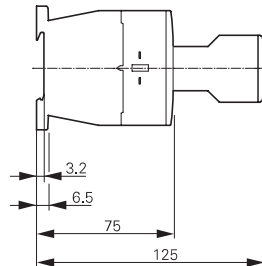
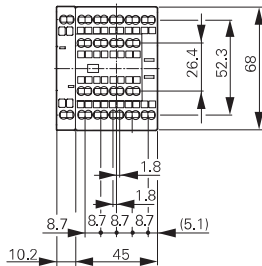

DILM17...DILM38
DILMC17...DILMC32
DILMF8...DILMF32

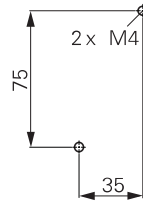
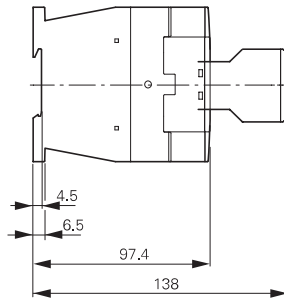
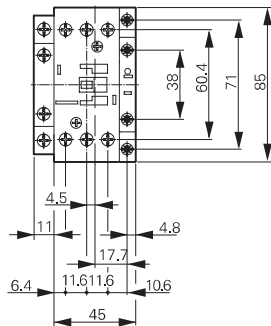

Clearance at side to grounded parts: 6 mm

1.16

Contactors

Basic devices up to 170 A, suppressor circuit

1 Contactors

DILM40...DILM72
DILMC40...DILMC65
DILMF40...DILMF65

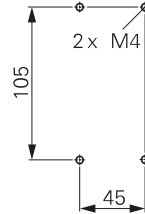
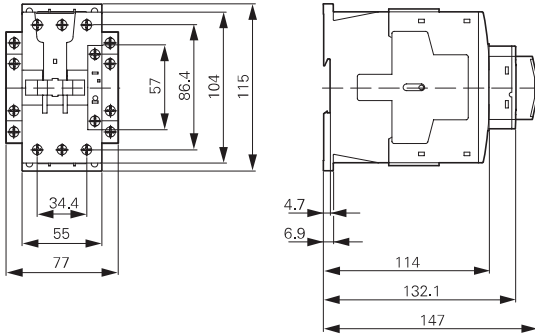

Clearance at side to grounded parts: 6 mm

DILM80...DILM170
DILMC80...DILMC150
DILMF80...DILMF150

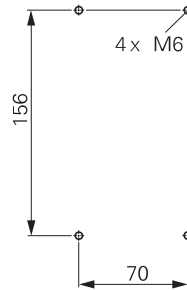
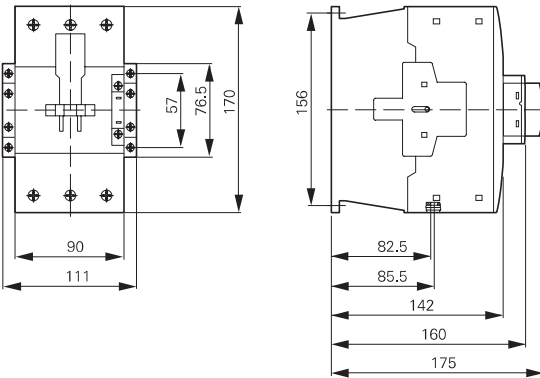

Clearance at side to grounded parts: 10 mm

Suppressor circuits

DILM...XSP...

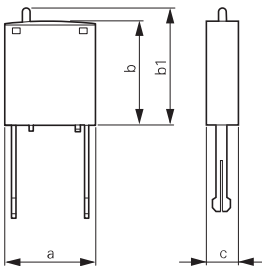

Part no.	a	b	b1	c
DILM12-XSP...	25	28	≈32	9
DILM32-XSP...	25	28	≈32	9
DILM95-XSP...	25	28	≈32	9

Contactor with auxiliary contact module

DILMP20

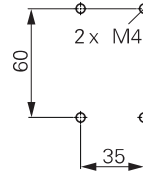
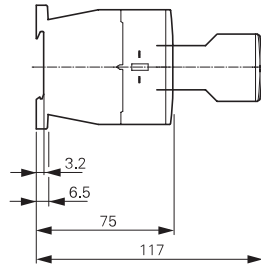
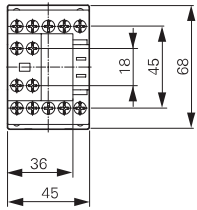

DILMP32

DILMP45

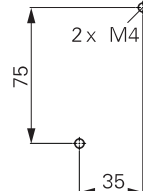
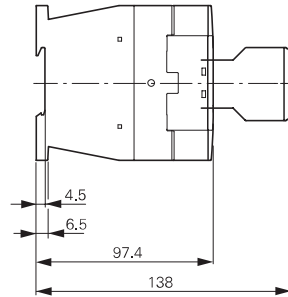
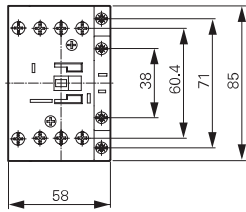

Distance at side to grounded parts: 6 mm

Contactors

DILMP63

DILMP80

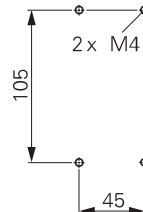
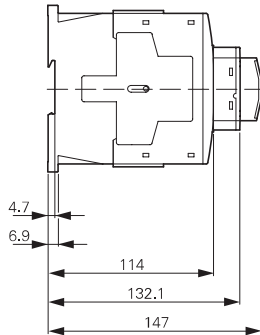
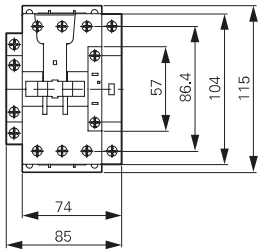

Distance at side to grounded parts: 6 mm

DILMP125

DILMP160

DILMP200

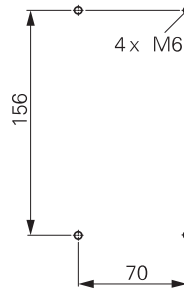
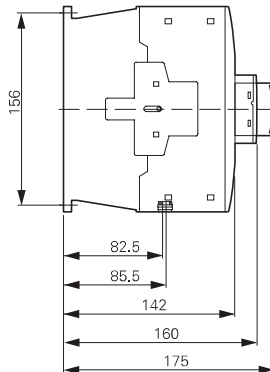
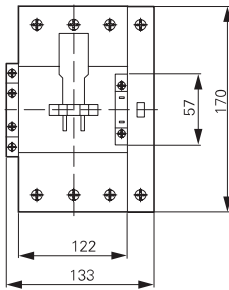

Clearance at side to earthed parts: 10 mm

Motor suppressor module

DILM12-XMSM

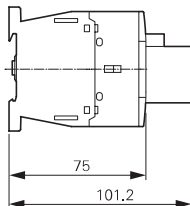
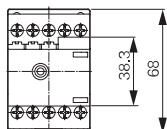

1.16

Contactors

Complete units for currents greater than 170 A

1 Complete units

DILM185A...DILM500
DILM250-S...DILM570-S

- ① DILM1000-XHI...-SI
- ② DILM1000-XHI11-SA

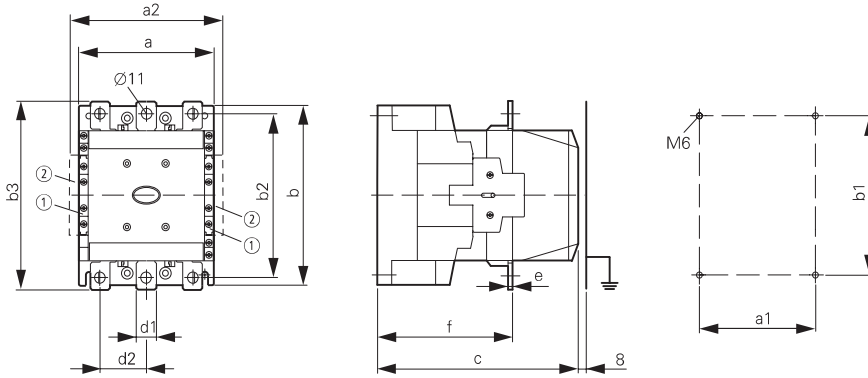

Part no.	a	a1	a2	b	b1	b2	b3	d1	d2	e	c	f
DILM185A	140	120	160	180	160	165	190	20	41	5	158	83
DILM225A	140	120	160	180	160	165	190	20	41	5	158	83
DILM250	140	120	160	180	160	164	189	25	48	5	208	140
DILM300A	140	120	160	180	160	164	189	25	48	5	208	140
DILM400	160	130	180	200	180	184	209	25	48	6	216	140
DILM500	160	130	180	200	180	189	219	38	57	6	216	140
DILM570	160	130	180	200	180	189	219	38	57	6	216	140

DILM580...DILM1000

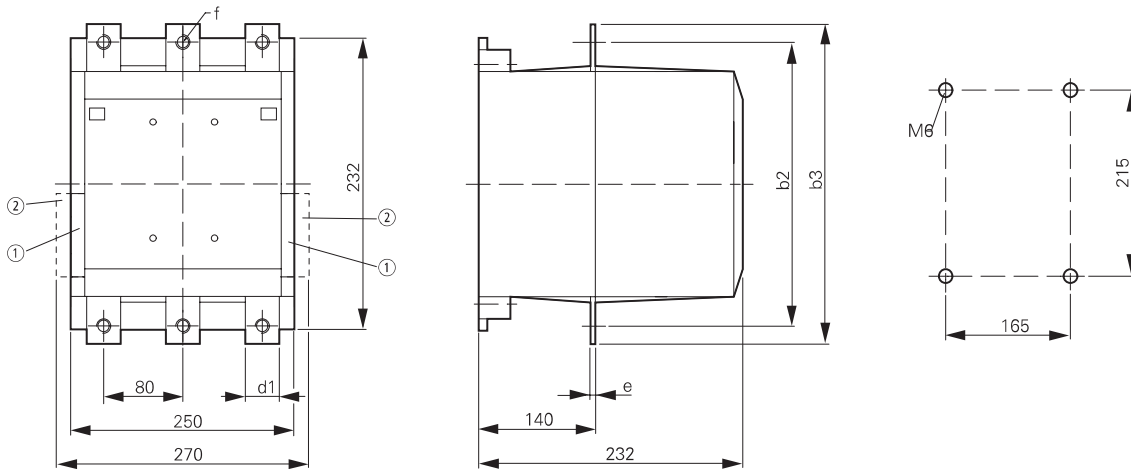

- ① DILM820-XHI...-SI
- ② DILM820-XHI11-SA

Part no.	b2	b3	d1	e	f
DILM580	256	296	45	6	13.5
DILM650	256	296	45	6	13.5
DILM750	256	296	45	6	13.5
DILM820	256	296	45	6	13.5
DILM1000	256	296	45	10	13.5

AC-1 contactors greater than 1000 A

DILH1400

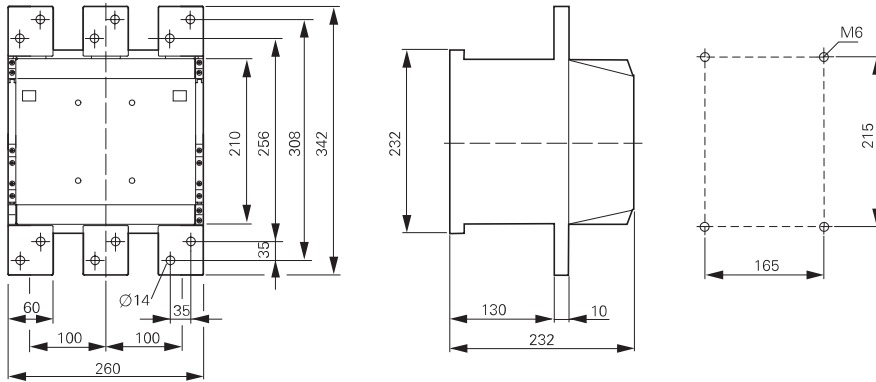

DILM1600

DILH2000

DILH2200

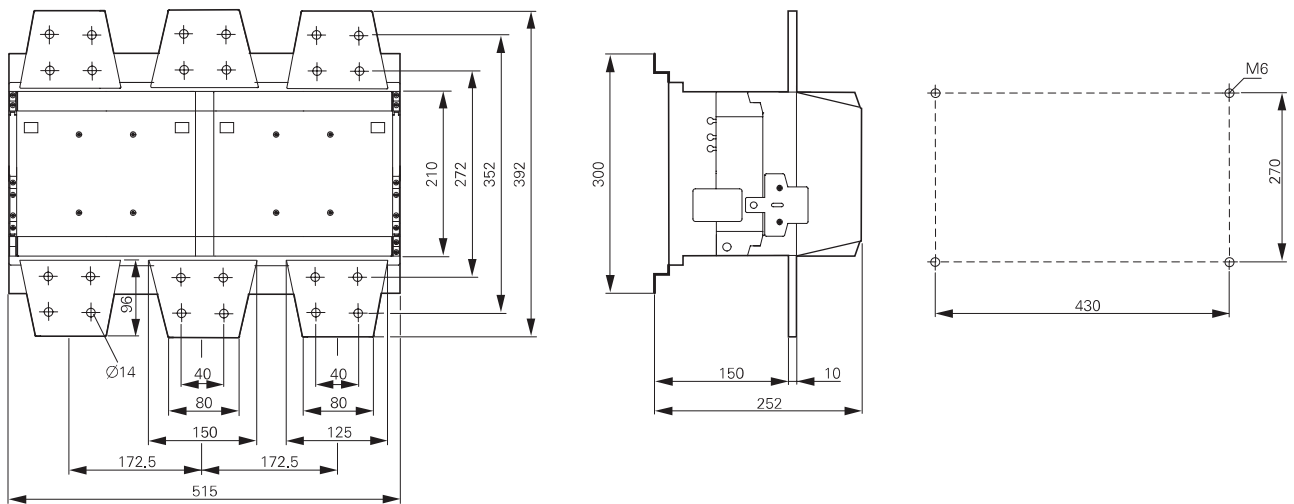

DILH2600

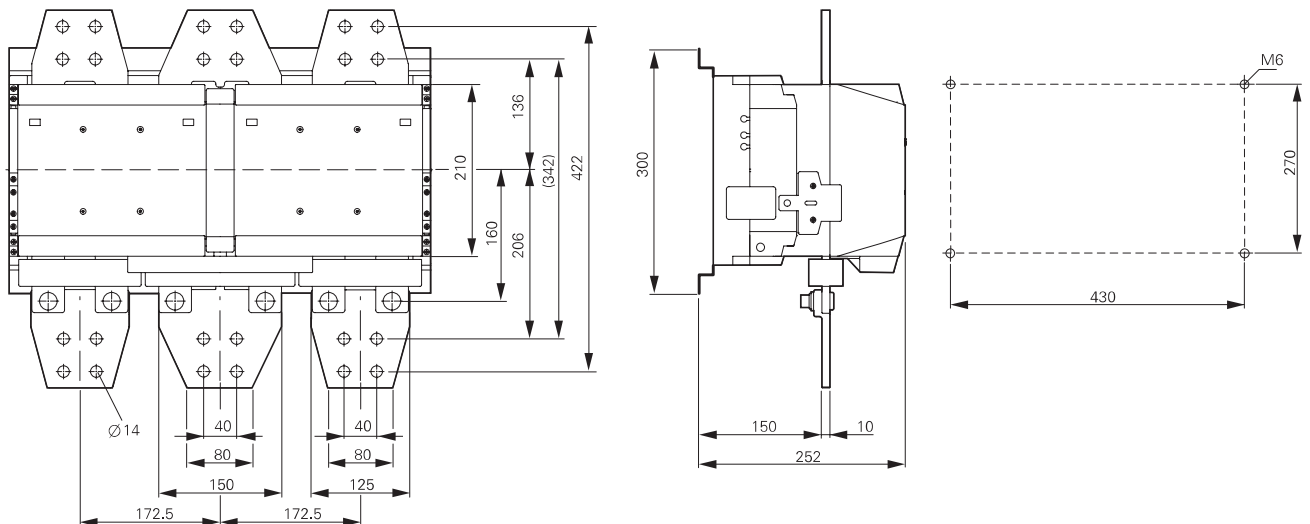

1.16

Contactors

Capacitor contactors, lamp contactors, contactor monitoring devices, SWD contactor modules

1 Contactor for capacitors

DILK...

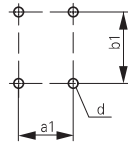
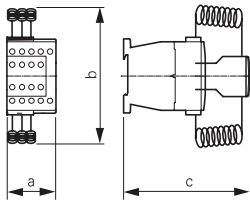

Part no.	a	b	c	a1	b1	d
DILK12	45	135	138	35	75	2 x M4
DILK20	45	135	138	35	75	2 x M4
DILK25	45	135	138	35	75	2 x M4
DILK33	55	190	147	45	105	2 x M4
DILK50	55	190	147	45	105	2 x M4

Illumination contactors

DILL...

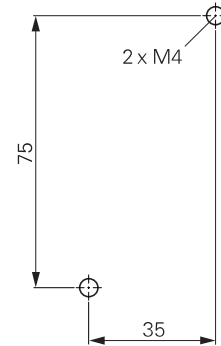
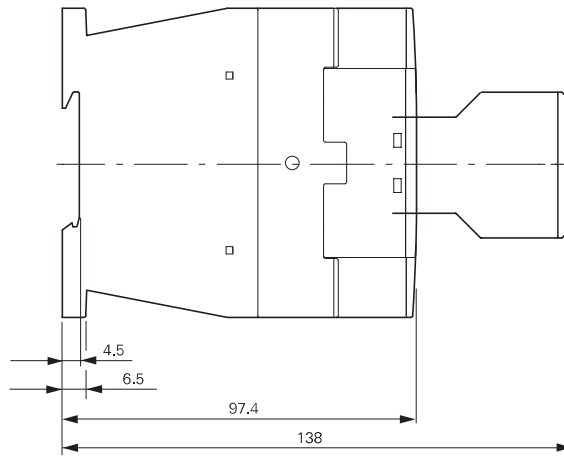
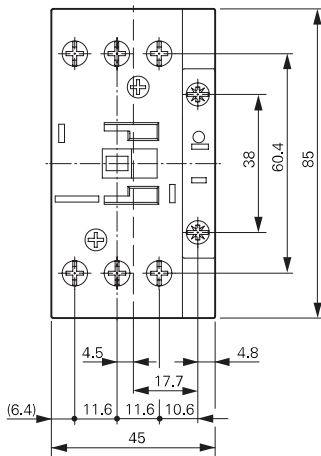

Clearance at side to grounded parts: 6 mm

Contactor monitoring devices

CMD(...)

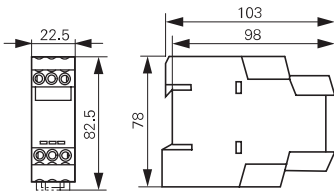

SWD contactor modules

DIL-SWD-32-...

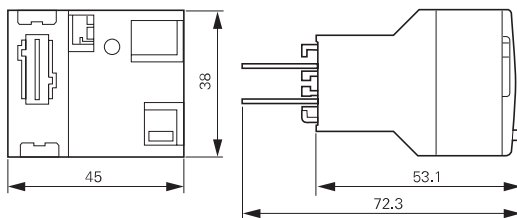

Star-delta contactors

SDAINLM12...SDAINLM115

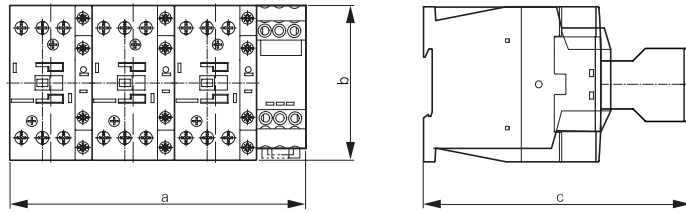

Part no.	a	b	c
SDAINLM12...22	158	68	117
SDAINLM30...55	158	85	138
SDAINLM70...115	188	115	147

SDAINLM140...SDAINLM260

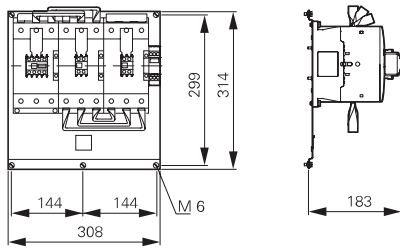

Reversing contactors

DIULM7...DIULM65

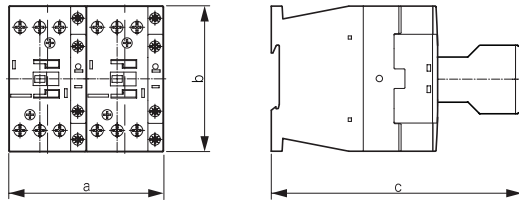

Part no.	a	b	c
DIULM7/21...12/21	90	68	117
DIULM17/21...32/21	90	85	138
DIULM40/11...65/11	110	115	147

DIULM80...DIULM150

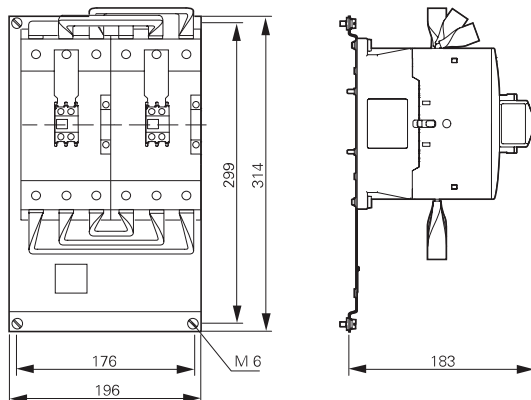

1.16

Contactors Accessories

1 Three-phase commoning links

DILM12-XDSB...

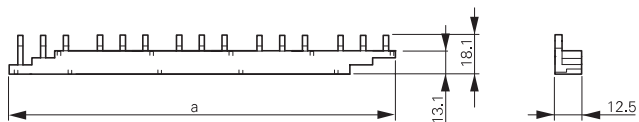

Part no.	a
DILM12-XDSB0/3	112
DILM12-XDSB0/4	157
DILM12-XDSB0/5	202

Electronic timer modules

DILM...XTE

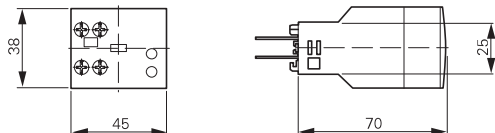

Amplifier module

ETS4-VS3

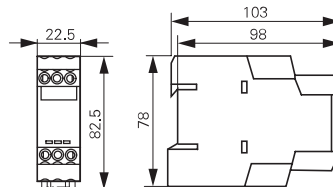

Wiring set for motor feeder plug

DILM12-XMCE

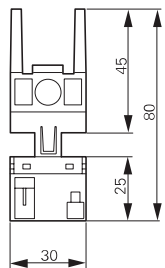
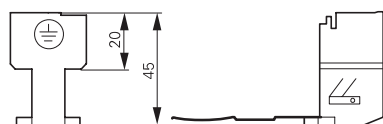

DILM12-XMCP/T

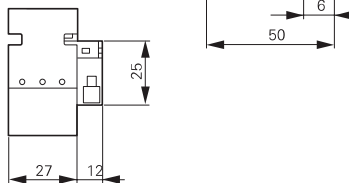
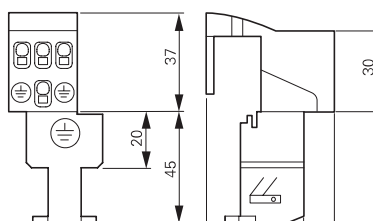

DILM12-XMCP/E

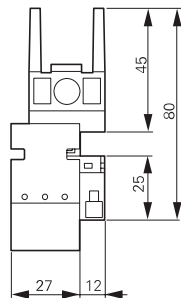
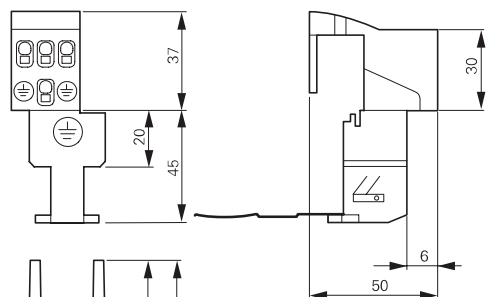

Contactors with terminal shrouds

DILM250...DILM1000 + DILM...-XHB

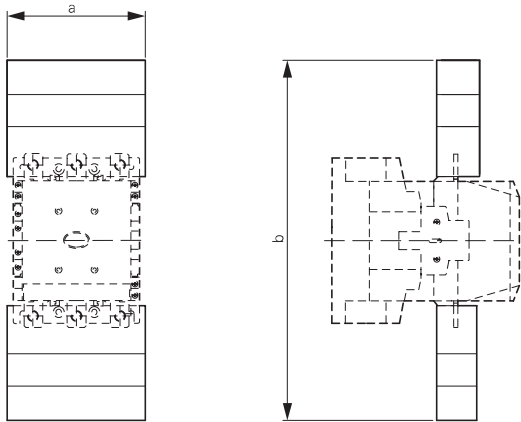

for part no.	a	b
DILM250, DILM300A	150	384
DILM400	150	404
DILM500	174	426
DILM580...1000	236	506

DILM250 + Z5-.../FF250

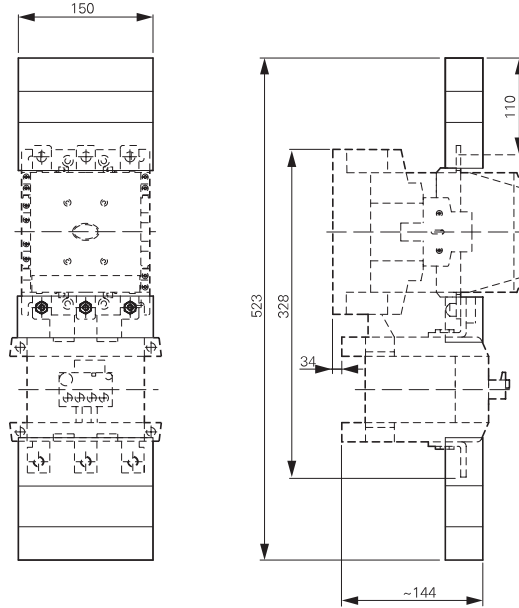

DILM185A...DILM225A + DILM225A-XHB

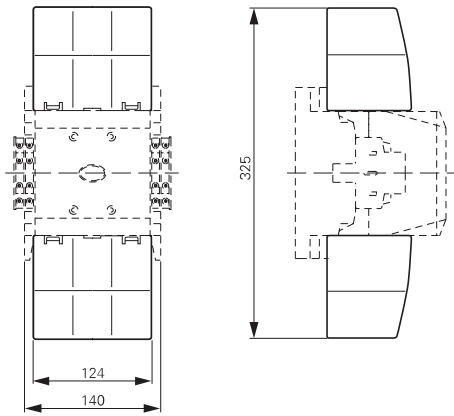

Contactor with star-point bridge and terminal shroud

DILM...XS1

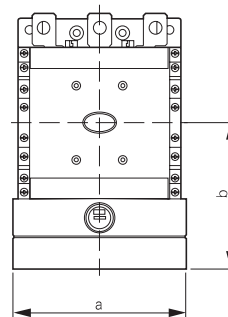

for part no.	a	b
DILM185...250	150	127
DILM300...400	150	137
DILM500	176	146

Mechanical interlock

DILM500-XMV

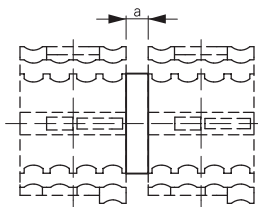

for part no.	a
DILM185...500	15

DILM820-XMV

