



selos+fasis

DIN RAIL **TERMINAL BLOCKS**

with Screw, Tension Spring and
Push-In Connection Technologies.

HELLO WIELAND ELECTRIC

Tradition and innovation - Wieland is representing the synergy of these two guiding principles for more than 100 years.

At Wieland Electric, we are proud to be the world market leader in electrical connections, and have been focusing on safe and innovative technologies since our founding. The beginnings of our success lie in the legendary Wieland Clamp, the first-ever safe electrical connector. Since then, innovation has pushed us to develop safer and more efficient ways to electrify the world.

Expanding from a component-only manufacturer, we are now one of the leading suppliers of innovative, future-oriented, and complete electrical solutions. We divide our focus into two main areas, Building and Industry. Our Building Solutions focus on decentralized power distribution and pluggable connections in all kinds of architectures and infrastructures. From in-store displays and lighting to hospitals and airports, and any structure in between – you build it, we power it! Our Industry Solutions center around functional safety for machines, industrial networking (IIoT and VPN), and power distribution. At Wieland, we keep your productivity going in mechanical engineering, wind power, material handling, HVAC, and many other industries.

We are at our customers' side in every step of the project, right from the start. Our experts offer consulting, on-site services, and technical support. We see ourselves as service providers, trainers and subject-matter experts.

1910
Founded in
Bamberg

1700+
Employees
worldwide

3
Production
sites

70+
Countries
worldwide

CONTENT

04	One System, many Possibilities
06	Wieland DIN Rail Terminal Blocks – Overview
08	wieplan CLICK2BUY
10	selos – DIN Rail Terminal Blocks with Screw Connection
44	selos WRT – The New Generation of High Current Terminals
52	selos BIT – Terminal Blocks for Electrical Installations with Screw Connection
58	fasis WKFN – DIN Rail Terminal Blocks with Tension Spring Connection
94	fasis CON – DIN Rail Terminal Blocks with Plug-In Connection
102	fasis MINI – DIN Rail Terminal Blocks with Tension Spring Connection for Installation in Confined Spaces
108	fasis BIT – DIN Rail Terminals for Installation distribution Board with Tension Spring Connection
114	fasis WTP – DIN Rail Terminal Blocks with Push-In Connection
130	Accessories
158	FACTS & DATA
163	Index
174	Information and contacts





ONE SYSTEM – MANY POSSIBILITIES

Three product families, three connection technologies – our DIN rail terminal block program is the right choice for every installation, wherever the control cabinet is found – in machinery or plant engineering, energy technology or building installation, or with screw, tension spring or push-in connection.

The ultimately flexible DIN rail terminal block systems selos and fasis offer optimum handling and harmonized accessories. This guarantees not only fast wiring time, but also reduces cost of inventory at your facility and in the supply chain.

Customized assembly service, customer-specific solutions and a comprehensive service portfolio match our products individually with the requirements of our customers.

- + Customized solutions
- + Abundant accessories
- + Mounting service

YOUR BENEFITS:

- + EFFICIENT PROJECT PLANNING WITH SOFTWARE
- + SAFE WIRING WITH PUSH-IN CONNECTION
- + CONTINUOUS LABELING SYSTEM

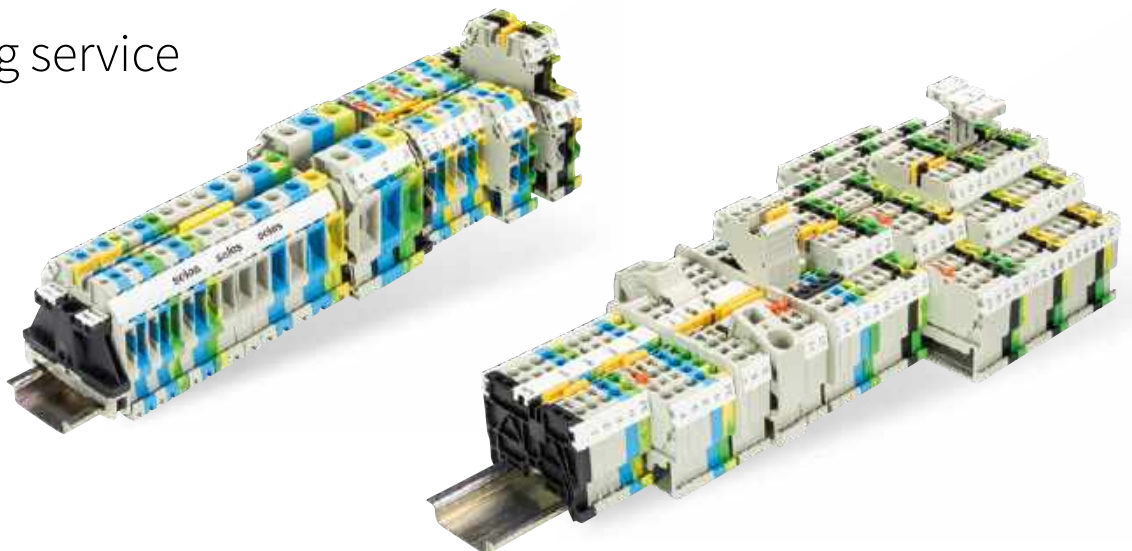

DIN RAIL TERMINAL BLOCKS – OVERVIEW

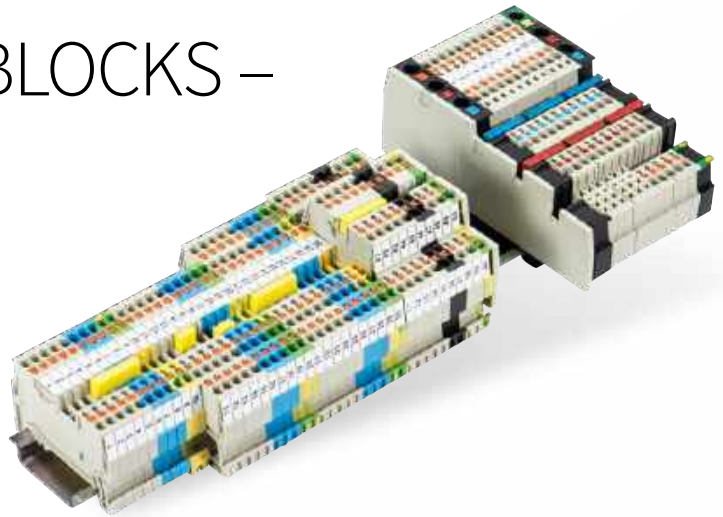

SELOS – DIN RAIL TERMINAL BLOCKS WITH SCREW CONNECTION



Feed-through blocks
starting at page 14



Ground blocks
starting at page 18



Duo feed-through blocks
starting at page 20



Knife edge
disconnect blocks
starting at page 21 + 30



Multi-tier blocks
starting at page 22



Initiator blocks
starting at page 26



Fuse blocks
starting at page 28



DIN rail terminal blocks with
plug-in connection
starting at page 34



Function blocks
starting at page 24 + 40



Instrument isolating
terminals
starting at page 38



DIN rail terminal blocks with ring
lug connection
starting at page 43



High current terminal blocks
starting at page 44



Mini blocks
starting at page 50



DIN rail terminal blocks for
installation distribution boards
starting at page 52



Triple-deck terminal blocks for ins-
tallation distribution boards starting
at page 56

FASIS – DIN RAIL TERMINAL BLOCKS WITH TENSION SPRING CONNECTION



Feed-through blocks
starting at page 62



Ground blocks
starting at page 70



Multi-tier blocks
starting at page 78



Knife edge
disconnect blocks
starting at page 88



Fuse blocks
starting at page 90



DIN rail terminal blocks with
plug-in connection
starting at page 94



Mini blocks
starting at page 102



Triple-deck terminal blocks for instal-
lation distribution boards starting at
page 112

FASIS – DIN RAIL TERMINAL BLOCKS WITH PUSH-IN CONNECTION



Multi-conductor terminals
starting at page 122



Initiator blocks
starting at page 121



Feed-through blocks
starting at page 122 + 126



Ground blocks
starting at page 123 + 127



Multi-tier blocks
starting at page 124



Triple-deck terminal blocks for instal-
lation distribution boards starting at
page 128

SOFTWARE + SERVICE



page 8 / 9 + page 158

ACCESSORIES



starting at page 130

WIEPLAN CLICK2BUY

Online terminal block configurator.

The **quick** way to a complete **pre-assembled DIN RAIL**:

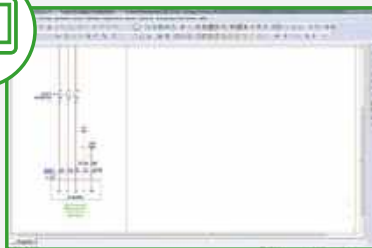

Design in CAE system



Product selection

**STEP
01**

**STEP
02**

QUICKER PLANNING

The simple integration of wieplan into your CAE environment will enable you to plan and respond much more quickly (with EPLAN CAE already integrated).

COMPLETE DOCUMENTATION

At the touch of a button you can download the complete documentation for your configured terminal strips including parts lists – even without registering.

QUICK PRICING

It is worth registering with wieplan Click to Buy as users who are logged in see our prices immediately – and can order directly.

Speed up **processes**. Use **opportunities**.

Meet tight deadlines and make design changes at short notice without any worry. As your partner we are set up to deal with short timeframes and small batch sizes – delivering on time without any errors. You can count on this!

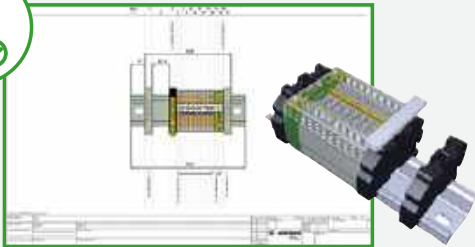

Documentation



Immediate pricing

STEP
03

STEP
04

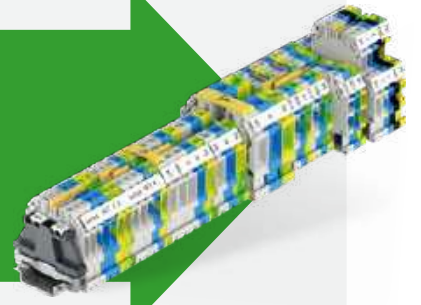

EXPERIENCE INDUSTRY 4.0

This consistent networking approach means that your order will go straight into production here – without any detours or delays.

FLEXIBLE IN LOGISTICS

We deliver the quantity you need. This will also save you high warehousing and logistics costs.

NO ADDITIONAL EFFORT

The tested terminal strips are customized and will be tailored precisely to your needs. We will deliver them ready-made, saving you additional work.

SELOS – DIN RAIL TERMINAL BLOCKS WITH SCREW CONNECTION

Reliable connection, proven concept! selos is our DIN rail terminal block with screw connection, solid and functional, known worldwide, and in use millions of times over. The selos series combines the classic screw connection with modern connection technology, with the focus on customer benefits and increased efficiency in wiring and the supply chain.

selos has been designed for use in machinery and plant construction as well as hazardous locations subject to explosion.

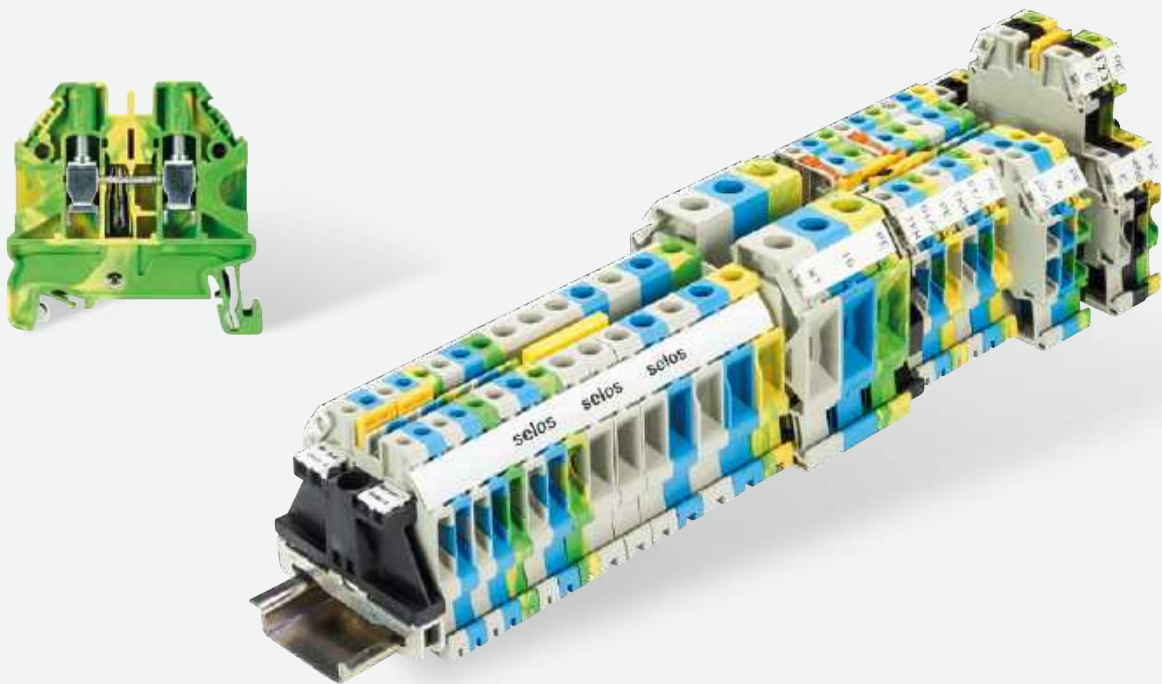

- + Includes feed-through and ground blocks with 2, 3 or 4 termination points
- + Multi-tier blocks in two- and three-tier designs
- + Knife-edge disconnect blocks and fuse blocks
- + Specialty function blocks are available with a wide variety of diode circuits
- + Diverse application-specific terminals, such as transformer disconnect terminals



PERFORMANCE FEATURES

- + Connection cross-section: up to 185 mm²
- + Rated current: up to 309 A IEC / 335 A UL / 365 A CSA
- + Rated voltage: up to 1000 V IEC / 600 V UL / 1000 V CSA

SELOS – DIN RAIL TERMINAL BLOCKS WITH SCREW CONNECTION

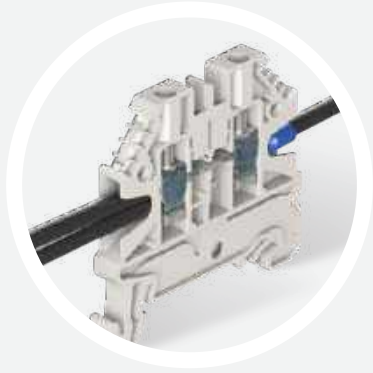

Simply connect

- Multi-wire connection
- Connect with or without ferrules

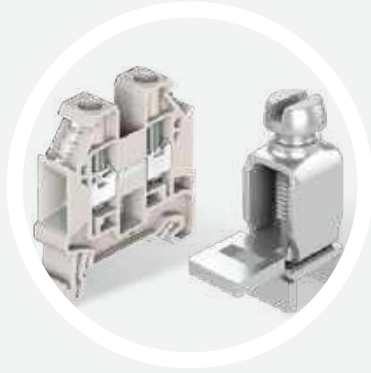

Reliable and maintenance-free

- Rugged clamping body design
- One-piece threaded collar
- Stress-free connecting and reconnecting



Time-saving assembly

- Snap-on screwless ground blocks

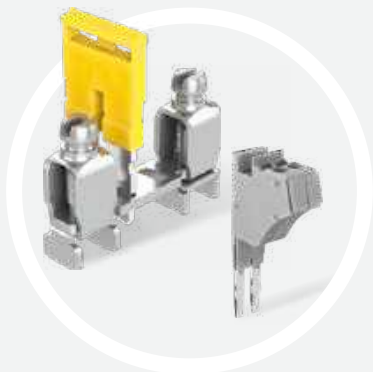

Plug & Play

- Dual jumpering channels
- Plug-in jumper bars
- Plug-in test adapter

FEATURES

- + Smaller size
- + Uniform design
- + Fewer accessories



JUMPERING SYSTEM – PERFECT TECHNOLOGY

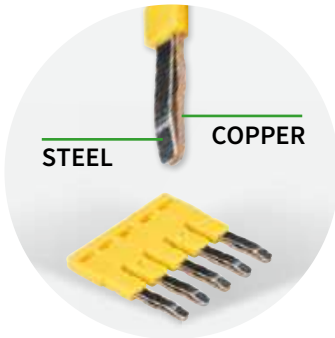

Perfect technology

- Copper current bar guarantees low contact resistance
- Steel spring guarantees strength, durability, and long-term stability



Extremely rugged!

- Indestructible steel spring
- Vibration-proof connection

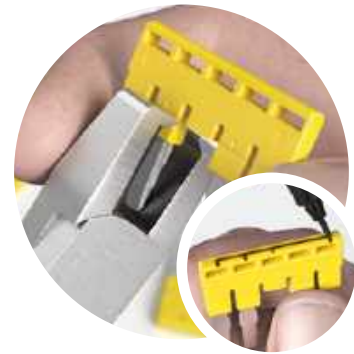

Simple customization

- Individual-poles easy to remove
- Circuits easy to identify

MARKING SYSTEM – RELIABLE IDENTIFICATION



Marking strips – Dependable

- Maximum hold to the terminal
- Solidify integrity of rail assembly



Endless strip – Effective

- Mounting facility for endless strips permits single step marking of entire assembly
- Continuous labeling
- Uses commercially available labeling systems



Marking tags – Individual

- Individual labeling with minimum effort
- Ideal for service and maintenance

SELOS · FEED-THROUGH BLOCKS WITH SCREW CONNECTION

WT 2,5

- Feed-through block with screw connection for mounting on TS 35
- Nominal cross section 2.5 mm²
- II 2G 2D Ex eb IIC
Follow the EX installation instructions on page 160
- Max. electrical data: 32 A/4 mm²
- Connection capacity: 2 wires, equal size 0.14 – 1.5 mm²



Description	Type	Part No.	Std. Pack
Feed-through block	gray WT 2,5	58.503.0055.0	100
Feed-through block	blue WT 2,5 BL	58.503.0055.6	100
GENERAL DATA			
Width / length / height, incl. TS 7.5	5 mm / 48 mm / 48 mm		
Wire strip length	9 mm	IEC Ex SEV14.0004 U	
Approvals			SEV 14 ATEX 0124 U
TECHNICAL DATA			
	IEC	UL	CSA
	EN 60 947-7-1		
Cross section fine-stranded	0.14 – 4 mm ²	IEC/EN 60 079-0/-7	
Cross section solid/stranded	0.14 – 4 mm ²	0.14 – 4 mm ²	
Cross section, AWG		26 – 12	26 – 12
Rated current	24 A	20 A	20 A
Rated voltage	1000 V	600 V	600 V
Rated impulse voltage	8 kV		690 V
Pollution degree	3		
ACCESSORIES			
	Type	Part No.	Std. Pack
End plate	AP WT 2,5-10	07.313.2555.0	10
Cross connector	2-pole	IVB WKF 2,5-2	10
	3-pole	IVB WKF 2,5-3	10
	4-pole	IVB WKF 2,5-4	10
	5-pole	IVB WKF 2,5-5	10
	10-pole	IVB WKF 2,5-10	20
	20-pole	IVB WKF 2,5-20	20

WT 4

- Feed-through block with screw connection for mounting on TS 35
- Nominal cross section 4 mm²
- II 2G 2D Ex eb IIC
Follow the EX installation instructions on page 160
- Max. electrical data: 41 A/6 mm²
- Connection capacity: 2 wires, equal size 0.14 – 2.5 mm²



Description	Type	Part No.	Std. Pack
Feed-through block	gray WT 4	58.504.0055.0	100
Feed-through block	blue WT 4 BL	58.504.0055.6	100
GENERAL DATA			
Width / length / height, incl. TS 7.5	6 mm / 48 mm / 48 mm		
Wire strip length	9 mm	IEC Ex SEV 14.0004 U	
Approvals			SEV 14 ATEX 0124 U
TECHNICAL DATA			
	IEC	UL	CSA
	EN 60 947-7-1		
Cross section fine-stranded	0.14 – 6 mm ²	IEC/EN 60 079-0/-7	
Cross section solid/stranded	0.14 – 6 mm ²	0.14 – 6 mm ²	
Cross section, AWG		26 – 10	26 – 10
Rated current	32 A	30 A	30 A
Rated voltage	1000 V	600 V	600 V
Rated impulse voltage	8 kV		690 V
Pollution degree	3		
ACCESSORIES			
	Type	Part No.	Std. Pack
End plate	AP WT 2,5-10	07.313.2555.0	10
Cross connector	2-pole	IVB WKF 4-2	10
	3-pole	IVB WKF 4-3	10
	4-pole	IVB WKF 4-4	10
	5-pole	IVB WKF 4-5	10
	10-pole	IVB WKF 4-10	20

WT 6

- Feed-through block with screw connection for mounting on TS 35
- Nominal cross section 6 mm²
- II 2G 2D Ex eb IIC
Follow the EX installation instructions on page 160
- Max. electrical data: 57 A/10 mm²
- Connection capacity: 2 wires, equal size 0.2 – 4 mm²





Description	Type	Part No.	Std. Pack
Feed-through block	gray WT 6	58.506.0055.0	100
Feed-through block	blue WT 6 BL	58.506.0055.6	100
GENERAL DATA			
Width / length / height, incl. TS 7.5	8 mm / 48 mm / 48 mm		
Wire strip length	11 mm	IEC Ex SEV 14.0004 U	
Approvals			SEV 14 ATEX 0124 U
TECHNICAL DATA			
	IEC	UL	CSA
	EN 60 947-7-1		
Cross section fine-stranded	0.2 – 10 mm ²	IEC/EN 60 079-0/-7	
Cross section solid/stranded	0.2 – 10 mm ²	0.2 – 10 mm ²	
Cross section, AWG		24 – 8	24 – 8
Rated current	41 A	50 A	50 A
Rated voltage	1000 V	600 V	600 V
Rated impulse voltage	8 kV		550 V
Pollution degree	3		
ACCESSORIES			
	Type	Part No.	Std. Pack
End plate	AP WT 2,5-10	07.313.2555.0	10
Cross connector	2-pole	IVB WKF 6-2	10
	3-pole	IVB WKF 6-3	10
	4-pole	IVB WKF 6-4	10
	5-pole	IVB WKF 6-5	10

More accessories page 130 ff.

WT 10

- Feed-through block with screw connection for mounting on TS 35
- Nominal cross section 10 mm²
-  II 2G 2D Ex eb IIC
Follow the EX installation instructions on page 160
- Max. electrical data: 76 A/ 16 mm²
- Connection capacity: 2 wires, equal size 0.5 – 6 mm²





Description	Type	Part No.	Std. Pack	
Feed-through block	gray WT 10	58.510.0055.0	50	
Feed-through block	blue WT 10 BL	58.510.0055.6	50	
GENERAL DATA				
Width / length / height, incl. TS 7.5	10 mm / 48 mm / 48 mm			
Wire strip length	13 mm			
Approvals	 ATEX IECEx IEC Ex SEV 14.0004 U SEV 14 ATEX 0124 U			
TECHNICAL DATA				
	IEC	UL	CSA	
	EN 60 947-7-1 IEC/EN 60 079-0/-7			
Cross section fine-stranded	0.5 – 16 mm ² 0.5 – 16 mm ²			
Cross section solid/stranded	0.5 – 16 mm ² 0.5 – 16 mm ²			
Cross section, AWG	20 – 6 20 – 6			
Rated current	57 A	65 A	65 A	57 A
Rated voltage	1000 V	600 V	600 V	690 V
Rated impulse voltage	8 kV			
Pollution degree	3			
ACCESSORIES				
	Type	Part No.	Std. Pack	
End plate	AP WT 2,5-10	07.313.2555.0	10	
Cross connector	2-pole IVB WKF 10-2	Z7.283.8227.0	10	

WT 16

- Feed-through block with screw connection for mounting on TS 35
- Nominal cross section 16 mm²
-  II 2G 2D Ex eb IIC
Follow the EX installation instructions on page 160
- Max. electrical data: 101 A/ 25 mm²
- Connection capacity: 2 wires, equal size 2.5 – 10 mm²



Description	Type	Part No.	Std. Pack	
Feed-through block	gray WT 16	58.516.0055.0	50	
Feed-through block	blue WT 16 BLAU	58.516.0055.6	50	
GENERAL DATA				
Width / length / height, incl. TS 7.5	12 mm / 58 mm / 54mm			
Wire strip length	15 mm			
Approvals	 ATEX IECEx IEC Ex SEV 14.0004 U SEV 14 ATEX 0124 U			
TECHNICAL DATA				
	IEC	UL	CSA	
	EN 60 947-7-1 IEC/EN 60 079-0/-7			
Cross section fine-stranded	4 – 25 mm ² 4 – 25 mm ²			
Cross section solid/stranded	1.5 – 25 mm ² 1.5 – 25 mm ²			
Cross section, AWG	16 – 4 14 – 4			
Rated current	76 A	85 A	85 A	76 A
Rated voltage	1000 V	600 V	600 V	690 V
Rated impulse voltage	8 kV			
Pollution degree	3			
ACCESSORIES				
	Type	Part No.	Std. Pack	
End plate	AP WT 16	07.313.2755.0	10	
Cross connector	2-pole IVB WKF 16-2	Z7.284.4227.0	10	

ACCESSORIES FOR SELOS WT 2,5 – WT 16



ACCESSORIES	Type	Part No.	Std. Pack	
Cover with warning symbol	for WT 2,5	AD WT 2,5	04.344.1455.8	10
	for WT 4	AD WT 4	04.344.1655.8	10
	for WT 6	AD WT 6/10	04.344.1855.8	10
	for WT 10	AD WT 6/10	04.344.1855.8	10
	for WT 16	AD WT 16	04.344.2255.8	10
Partition for WT 2,5 – WT 10	TW WT 2,5-10	07.313.2655.0	10	
Partition for WT 16	TW WT 4E	07.313.2855.0	10	
Test adapter modular for WT 2,5 and 4	PS WKCF	Z1.299.9753.0	10	
End plate for test adapter *	ZP/AP PS	07.312.6053.0	10	

* for WT4 an end cover plate must be snapped in after each test connector

SELOS · FEED-THROUGH BLOCKS WITH SCREW CONNECTION

WKN 35 / U

- Feed-through block with screw connection for mounting on TS 35 and TS 32
- Nominal cross section 35 mm²
- Ex e I/II  II 2GD IM2
Follow the EX installation instructions on page 160
- Enclosed design



Description	Type	Part No.	Std. Pack
Feed-through block	gray WKN 35/U	57.535.0155.0	20
Feed-through block Exi	blue WKN 35/U BLAU	57.535.0155.6	20

GENERAL DATA				
Width / length / height, incl. TS 7.5	16 mm / 71 mm / 68 mm			
Wire strip length	18 mm			IECEX SEV 15.0002 U
Approvals	 ATEX CAN-Ex USA-Ex			SEV 15 ATEX 0108 U

TECHNICAL DATA	IEC	UL	CSA	
	EN 60 947-7-1			
Cross section fine-stranded	10 – 35 mm ²	10 – 1/0 AWG	10 – 1/0 AWG	IEC/EN 60 079-0/-7
Cross section solid/stranded	10 – 50 mm ²			10 – 35 mm ²
Rated current	125 A	150 A	150 A	125 A
Rated voltage	800 V *)	600 V	600 V	690 V
Rated impulse voltage	8 kV			
Pollution degree	3			

ACCESSORIES	Type	Part No.	Std. Pack
Partition	gray TWN 35	07.311.7855.0	10
Cross connector with screws, insulated	2-pole	IVB WKN 35 - 2	5
	3-pole	IVB WKN 35 - 3	5
	up to 6-pole	IVB WKN 35 - 6	5
	up to 12-pole	IVB WKN 35 - 12	5
Single cover with marking facility	AD VB 35 GELB	04.326.2553.8	10
Cover with warning symbol over 4 blocks	AD VB 16/4 GELB	04.343.5256.8	10

*) higher voltage upon request

WKN 70 / U

- Feed-through block with screw connection for mounting on TS 35 and TS 32
- Nominal cross section 70 mm²
- Ex e I/II  II 2GD IM2
Follow the EX installation instructions on page 160
- Enclosed design



Description	Type	Part No.	Std. Pack
Feed-through block	gray WKN 70/U	57.570.0155.0	20
Feed-through block Exi	blue WKN 70/U BLAU	57.570.0155.6	20

GENERAL DATA				
Width / length / height, incl. TS 7.5	24 mm / 77 mm / 81 mm			
Wire strip length	24 mm			IECEX SEV 15.0002 U
Approvals	 ATEX CAN-Ex IECEx			SEV 15 ATEX 0108 U

TECHNICAL DATA	IEC	UL	CSA	
	EN 60 947-7-1			
Cross section fine-stranded	10 – 70 mm ²	6 – 2/0 AWG	6 – 2/0 AWG	IEC/EN 60 079-0/-7
Cross section solid/stranded	16 – 95 mm ²			16 – 95 mm ²
Rated current	192 A	175/175 A	170 A	192 A
Rated voltage	800 V *)	600 V	600 V	690 V
Rated impulse voltage	8 kV			
Pollution degree	3			

ACCESSORIES	Type	Part No.	Std. Pack
Partition	gray TWN 70	07.311.7955.0	10
Cross connector with screws, insulated	2-pole	VB WKN 70 - 2	10
	3-pole	VB WKN 70 - 3	10
	up to 6-pole	VB WKN 70 - 6	10
Single cover with marking facility	AD VB 70 GELB	04.326.2653.8	10
Cover with warning symbol over 4 blocks	AD VB 24/4 GELB	04.343.5356.8	10

*) higher voltage upon request

WKN 150 / U

- Feed-through block with screw connection for mounting on TS 35 and TS 32
- Nominal cross section 150 mm²
- Ex e I/II  II GD IM2
Follow the EX installation instructions on page 160
- Enclosed design



Description	Type	Part No.	Std. Pack
Feed-through block	gray WKN 150/U	57.597.0155.0	10
Feed-through block Exi	blue WKN 150/U BLAU	57.597.0155.6	10

GENERAL DATA				
Width / length / height, incl. TS 7.5	28 mm / 96 mm / 99 mm			
Wire strip length	30 mm			IECEX SEV 15.0002 U
Approvals	 ATEX CAN-Ex IECEx			SEV 15 ATEX 0108 U

TECHNICAL DATA	IEC	UL	CSA	
	EN 60 947-7-1			
Cross section fine-stranded	35 – 150 mm ²	2/0 AWG-350 kcmil	2/0 AWG-350 kcmil	IEC/EN 60 079-0/-7
Cross section solid/stranded	35 – 185 mm ²			35 – 150 mm ²
Rated current	309 A	335/335 A	365 A	309 A
Rated voltage	1000 V	600 V	1000 V	690 V
Rated impulse voltage	8 kV			
Pollution degree	3			

ACCESSORIES	Type	Part No.	Std. Pack
Partition	gray		
Cross connector with screws, insulated	2-pole	VB WKN 150 - 2	5
	3-pole	VB WKN 150 - 3	5
Cover with warning symbol over 4 blocks	AD VB 28/4 GELB	04.343.5456.8	10





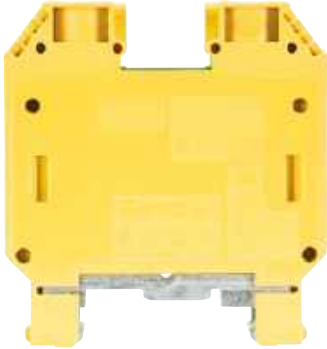

More accessories page 130 ff.

SELOS · GROUND BLOCKS WITH SCREW CONNECTION

WKN 35 SL

- Ground block with screw connection for mounting on TS 35
- Nominal cross section 35 mm²
- Ex e I/II  II 2GD IM2
Follow the EX installation instructions on page 160
- Enclosed design





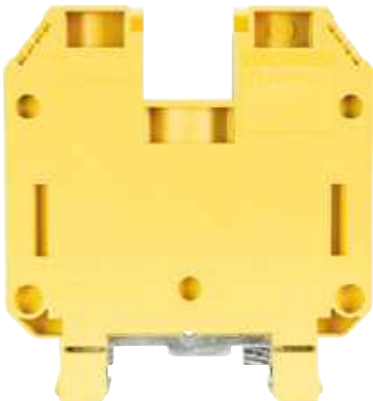

Description	Type	Part No.	Std. Pack
Ground block	green/yellow WKN 35 SL	57.535.9055.0	20
GENERAL DATA			
Width / length / height, incl. TS 7.5	16 mm / 63 mm / 68 mm		
Wire strip length	20 mm		
Approvals	     		
TECHNICAL DATA			
	IEC	UL	CSA
	EN 60 947-7-2		
Cross section fine-stranded	EN 60 079-0/-7		
Cross section solid/stranded	10 – 35 mm ²		
Cross section, AWG	10 – 50 mm ²		
Rated current	10 – 2	10 – 2	
Rated voltage	800 V	600 V	600 V
Rated impulse voltage	8 kV		
Pollution degree	3		

WKN 70 SL

- Ground block with screw connection for mounting on TS 35
- Nominal cross section 70 mm²
- Ex e I/II  II 2GD IM2
Follow the EX installation instructions on page 160
- Enclosed design







Description	Type	Part No.	Std. Pack
Ground block	green/yellow WKN 70 SL	57.570.9055.0	20
GENERAL DATA			
Width / length / height, incl. TS 7.5	24 mm / 75 mm / 81 mm		
Wire strip length	24 mm		
Approvals	    		
TECHNICAL DATA			
	IEC	UL	CSA
	EN 60 947-7-2		
Cross section fine-stranded	EN 60 079-0/-7		
Cross section solid/stranded	10 – 70 mm ²		
Cross section, AWG	16 – 95 mm ²		
Rated current	6 – 2/0	6 – 2/0	
Rated voltage	800 V	600 V	600 V
Rated impulse voltage	8 kV		
Pollution degree	3		

SELOS · GROUND BLOCKS WITH SCREW CONNECTION

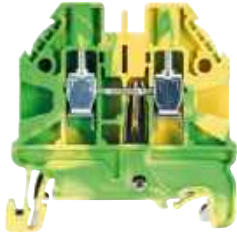
WT 2,5 PE

- Ground block with screw connection for mounting on TS 35
- Nominal cross section 2.5 mm²
-  II 2G 2D Ex eb IIC
Follow the EX installation instructions on page 160
- Connection capacity: 2 wires, equal size 0.14 – 1.5 mm²







Description	Type	Part No.	Std. Pack
Ground block	green/yellow WT 2,5 PE	58.503.9055.0	100
GENERAL DATA			
Width / length / height, incl. TS 7.5	5 mm / 48 mm / 48 mm		
Wire strip length	9 mm		
Approvals	   ATEX IECEx		
TECHNICAL DATA			
	IEC	UL	CSA
			
	EN 60 947-7-2		
Cross section fine-stranded	IEC/EN 60 079-0/-7		
Cross section solid/stranded	0.14 – 4 mm ²		
Cross section, AWG	0.14 – 4 mm ²		
Rated current	26 – 12	26 – 12	
Rated voltage	1000 V	600 V	600 V
Rated impulse voltage	8 kV		
Pollution degree	3		
ACCESSORIES			
	Type	Part No.	Std. Pack
End plate	AP WT 2,5 - 10	07.313.2555.0	10

WT 4 PE

- Ground block with screw connection for mounting on TS 35
- Nominal cross section 4 mm²
-  II 2G 2D Ex eb IIC
Follow the EX installation instructions on page 160
- Connection capacity: 2 wires, equal size 0.14 – 2.5 mm²







Description	Type	Part No.	Std. Pack
Ground block	green/yellow WT 4 PE	58.504.9055.0	100
GENERAL DATA			
Width / length / height, incl. TS 7.5	6 mm / 48 mm / 48 mm		
Wire strip length	9 mm		
Approvals	   ATEX IECEx		
TECHNICAL DATA			
	IEC	UL	CSA
			
	EN 60 947-7-2		
Cross section fine-stranded	IEC/EN 60 079-0/-7		
Cross section solid/stranded	0.14 – 6 mm ²		
Cross section, AWG	0.14 – 6 mm ²		
Rated current	26 – 10	26 – 10	
Rated voltage	1000 V	600 V	600 V
Rated impulse voltage	8 kV		
Pollution degree	3		
ACCESSORIES			
	Type	Part No.	Std. Pack
End plate	AP WT 2,5 - 10	07.313.2555.0	10

WT 6 PE

- Ground block with screw connection for mounting on TS 35
- Nominal cross section 6 mm²
-  II 2G 2D Ex eb IIC
Follow the EX installation instructions on page 160
- Connection capacity: 2 wires, equal size 0.2 – 4 mm²







Description	Type	Part No.	Std. Pack
Ground block	green/yellow WT 6 PE	58.506.9055.0	100
GENERAL DATA			
Width / length / height, incl. TS 7.5	8 mm / 48 mm / 48 mm		
Wire strip length	11 mm		
Approvals	   ATEX IECEx		
TECHNICAL DATA			
	IEC	UL	CSA
			
	EN 60 947-7-2		
Cross section fine-stranded	IEC/EN 60 079-0/-7		
Cross section solid/stranded	0.2 – 10 mm ²		
Cross section, AWG	0.2 – 10 mm ²		
Rated current	24 – 8	24 – 8	
Rated voltage	1000 V	600 V	600 V
Rated impulse voltage	8 kV		
Pollution degree	3		
ACCESSORIES			
	Type	Part No.	Std. Pack
End plate	AP WT 2,5 - 10	07.313.2555.0	10

WT 10 PE

- Ground block with screw connection for mounting on TS 35
- Nominal cross section 10 mm²
-  II 2G 2D Ex eb IIC
Follow the EX installation instructions on page 160
- Connection capacity: 2 wires, equal size 0.5 – 6 mm²







Description	Type	Part No.	Std. Pack
Ground block	green/yellow WT 10 PE	58.510.9055.0	50
GENERAL DATA			
Width / length / height, incl. TS 7.5	10 mm / 48 mm / 48 mm		
Wire strip length	13 mm		IEC Ex SEV 14.0004 U
Approvals	   ATEX IECEX		SEV 14 ATEX 0124 U
TECHNICAL DATA			
	IEC	UL	CSA
			
	EN 60 947-7-2		IEC/EN 60 079-0/-7
Cross section fine-stranded	0.5 – 16 mm ²		0.5 – 16 mm ²
Cross section solid/stranded	0.5 – 16 mm ²		0.5 – 16 mm ²
Cross section, AWG		20 – 6	20 – 6
Rated current			
Rated voltage	1000 V	600 V	600 V
Rated impulse voltage	8 kV		
Pollution degree	3		
ACCESSORIES			
	Type	Part No.	Std. Pack
End plate	AP WT 2,5 - 10	07.313.2555.0	10

WT 16 PE

- Ground block with screw connection for mounting on TS 35
- Nominal cross section 16 mm²
-  II 2G 2D Ex eb IIC
Follow the EX installation instructions on page 160
- Connection capacity: 2 wires, equal size 2.5 – 10 mm²



Description	Type	Part No.	Std. Pack
Ground block	green/yellow WT 16 PE	58.516.9055.0	100
GENERAL DATA			
Width / length / height, incl. TS 7.5	12 mm / 58 mm / 54 mm		
Wire strip length	15 mm		IEC Ex SEV 14.0004 U
Approvals	   ATEX IECEX		SEV 14 ATEX 0124 U
TECHNICAL DATA			
	IEC	UL	CSA
			
	EN 60 947-7-2		IEC/EN 60 079-0/-7
Cross section fine-stranded	4 – 25 mm ²		4 – 25 mm ²
Cross section solid/stranded	1.5 – 25 mm ²		1.5 – 25 mm ²
Cross section, AWG		16 – 4	14 – 4
Rated current			
Rated voltage	1000 V	600 V	600 V
Rated impulse voltage	8 kV		
Pollution degree	3		
ACCESSORIES			
	Type	Part No.	Std. Pack
End plate	AP WT 16	07.313.2755.0	10

SELOS · DUO FEED-THROUGH AND DUO-GROUND BLOCKS WITH SCREW CONNECTION

WT 4 D1/2 | WT 4 D1/2 PE

- Duo feed-through block / duo-ground block with screw connection for mounting on TS 35
- Nominal cross section 4 mm²
-  II 2G 2D Ex eb IIC
Follow the EX installation instructions on page 160
- Max. electrical data: 41 A / 6 mm²
- Connection capacity: 2 wires, equal size 0.14 – 2.5 mm²

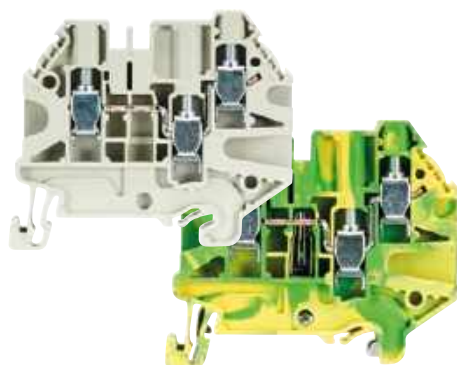

Description	Type	Part No.	Std. Pack
Duo feed-through block	gray WT 4 D1/2	58.504.5055.0	100
Duo feed-through block	blue WT 4 D1/2 BL	58.504.5055.6	100
Duo-ground block	green/yellow WT 4 D1/2 PE	58.504.9355.0	100

GENERAL DATA			
Width / length / height, incl. TS 7.5	6 mm / 56 mm / 50 mm		
Wire strip length	9 mm		
Approvals	 ATEX IECEx		
	IEC Ex SEV 14.0004 U SEV 14 ATEX 0124 U		

TECHNICAL DATA	IEC	UL	CSA	
	EN 60 947-7-1			
Cross section fine-stranded	0.14 – 6 mm ²			IEC/EN 60 079-0/-7
Cross section solid/stranded	0.14 – 6 mm ²			0.14 – 6 mm ²
Cross section, AWG				
Rated current	32 A	26 – 10 30 A	26 – 10 30 A	32 A
Rated voltage	500 V	300 V	300 V	550 V
Rated impulse voltage	6 kV			
Pollution degree	3			

ACCESSORIES	Type	Part No.	Std. Pack
End plate	AP WT 4 D1/2	07.313.2955.0	10
Partition	TW WT 4 E	07.313.2855.0	10
Cross connector	2-pole IVB WKF 4-2	Z7.261.1227.0	10
	3-pole IVB WKF 4-3	Z7.261.1327.0	10
	4-pole IVB WKF 4-4	Z7.261.1427.0	10
	5-pole IVB WKF 4-5	Z7.261.1527.0	10
	10-pole IVB WKF 4-10	Z7.261.2027.0	10

WT 4 D2/2 | WT 4 D2/2 PE

- Duo feed-through block / duo-ground block with screw connection for mounting on TS 35
- Nominal cross section 4 mm²
-  II 2G 2D Ex eb IIC
Follow the EX installation instructions on page 160
- Max. electrical data: 41 A / 6 mm²
- Connection capacity: 2 wires, equal size 0.14 – 2.5 mm²

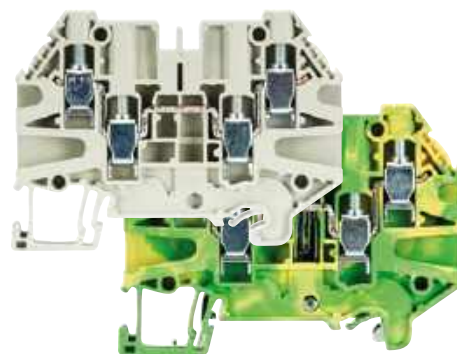

Description	Type	Part No.	Std. Pack
Duo feed-through block	gray WT 4 D2/2	58.504.5155.0	100
Duo feed-through block	blue WT 4 D2/2 BLAU	58.504.5155.6	100
Duo-ground block	green/yellow WT 4 D2/2 PE	58.504.9155.0	100

GENERAL DATA			
Width / length / height, incl. TS 7.5	6 mm / 68 mm / 50 mm		
Wire strip length	9 mm		
Approvals	 ATEX IECEx		
	IEC Ex SEV 14.0004 U SEV 14 ATEX 0124 U		

TECHNICAL DATA	IEC	UL	CSA	
	EN 60 947-7-1			
Cross section fine-stranded	0.14 – 6 mm ²			IEC/EN 60 079-0/-7
Cross section solid/stranded	0.14 – 6 mm ²			0.14 – 6 mm ²
Cross section, AWG				
Rated current	32 A	26 – 10 30 A	26 – 10 30 A	32 A
Rated voltage	500 V	300 V	300 V	440 V
Rated impulse voltage	6 kV			
Pollution degree	3			

ACCESSORIES	Type	Part No.	Std. Pack
End plate	AP WT 4 D2/2	07.313.3155.0	10
Partition	TW WT 4 E	07.313.2855.0	10
Cross connector	2-pole IVB WKF 4-2	Z7.261.1227.0	10
	3-pole IVB WKF 4-3	Z7.261.1327.0	10
	4-pole IVB WKF 4-4	Z7.261.1427.0	10
	5-pole IVB WKF 4-5	Z7.261.1527.0	10
	10-pole IVB WKF 4-10	Z7.261.2027.0	10

SELOS · KNIFE EDGE DISCONNECT AND FUSE BLOCKS WITH SCREW CONNECTION

WT 2,5 TKM...

- Knife edge disconnect block for mounting on TS 35
- Nominal cross section 2,5 mm²
- Connection capacity: 2 wires, equal size 0,14 – 1,5 mm²



Description	Type	Part No.	Std. Pack
Knife edge disconnect block	gray WT 2,5 TKM	58.503.2055.0	100
Knife edge disconnect block with 2 test bolts	blue WT 2,5 TKM BL gray WT 2,5 TKM P	58.503.2055.6 58.503.2355.0	100 100
Feed-through block, identically-shaped	gray WT 2,5 TKM D	58.503.2155.0	100
Feed-through block, identically-shaped	blue WT 2,5 TKM D BL	58.503.2155.6	100

GENERAL DATA	
Width / length / height, incl. TS 7.5	5 mm / 56 mm / 50 mm
Wire strip length	9 mm
Approvals	☐

TECHNICAL DATA		IEC	
Cross section fine-stranded		0.14 – 4 mm ²	
Cross section solid/stranded		0.14 – 4 mm ²	
Cross section, AWG			
Rated current		20 A	
Rated voltage		500 V	
Rated impulse voltage		6 kV	
Pollution degree		3	

ACCESSORIES		Type	Part No.	Std. Pack
End plate		AP WT 4 D1/2	07.313.2955.0	10
Partition		TW WT 4 E	07.313.2855.0	10
Cross connector		2-pole IVB WKF 2,5-2	Z7.280.6227.0	10
		5-pole IVB WKF 2,5-5	Z7.280.6527.0	10
		10-pole IVB WKF 2,5-10	Z7.280.7027.0	10
		20-pole IVB WKF 2,5-20	Z7.280.8027.0	10

WT 4 TKM...

- Knife edge disconnect block for mounting on TS 35
- Nominal cross section 4 mm²
- Connection capacity: 2 wires, equal size 0,14 – 2,5 mm²



Description	Type	Part No.	Std. Pack
Knife edge disconnect block	gray WT 4 TKM	58.504.2055.0	100
Knife edge disconnect block with 2 test bolts	blue WT 4 TKM BL gray WT 4 TKM P	58.504.2055.6 58.504.2355.0	100 100

GENERAL DATA	
Width / length / height, incl. TS 7.5	6 mm / 56 mm / 50 mm
Wire strip length	9 mm
Approvals	☐ VDE

TECHNICAL DATA		IEC		UL	CSA
Cross section fine-stranded		0.14 – 6 mm ²			
Cross section solid/stranded		0.14 – 6 mm ²			
Cross section, AWG				26 – 10	26 – 10
Rated current				24 A	16 A
Rated voltage				500 V	300 V
Rated impulse voltage				6 kV	
Pollution degree				3	

ACCESSORIES		Type	Part No.	Std. Pack
End plate		AP WT 4 D1/2	07.313.2955.0	10
Partition		TW WT 4 E	07.313.2855.0	10
Cross connector		2-pole IVB WKF 4-2	Z7.261.1227.0	10
		5-pole IVB WKF 4-5	Z7.261.1527.0	10
		10-pole IVB WKF 4-10	Z7.261.2027.0	10

WT 4 FSI

- Fuse block for automobile fuses (mini) for mounting on TS 35
- Nominal cross section 4 mm²
- Connection capacity: 2 wires, equal size 0,14 – 2,5 mm²

¹⁾ Observe the derating curve, available in our e-catalog at <https://eshop.wieland-electric.com>

²⁾ determined by the fuse inserted



Description	Type	Part No.	Std. Pack
Fuse block	gray WT 4 FSI	58.504.4155.0	100

GENERAL DATA	
Width / length / height, incl. TS 7.5	6 mm / 56 mm / 50 mm
Wire strip length	9 mm
Approvals	

TECHNICAL DATA		IEC	
Cross section fine-stranded		0.14 – 6 mm ²	
Cross section solid/stranded		0.14 – 6 mm ²	
Cross section, AWG			
Rated current		max. 20 A ¹⁾	
Rated voltage		²⁾	
Rated impulse voltage		6 kV	
Pollution degree		3	



ACCESSORIES		Type	Part No.	Std. Pack
End plate		AP WT 4 D1/2	07.313.2955.0	10
Partition		TW WT 4 E	07.313.2855.0	10
Cross connector		2-pole IVB WKF 4-2	Z7.261.1227.0	10
		5-pole IVB WKF 4-5	Z7.261.1527.0	10
		10-pole IVB WKF 4-10	Z7.261.2027.0	10

SELOS · MULTI-TIER BLOCKS WITH SCREW CONNECTION

WKN 2,5 E/U

- Multi-tier block for mounting on TS 35 and TS 32
- Nominal cross section 2.5 mm²
- Class I, Zone 1, AEx, e, II, T6





Description	Type	Part No.	Std. Pack
Multi-tier block	gray WKN 2,5 E/U	57.403.7055.0	100
GENERAL DATA			
Width / length / height, incl. TS 7.5	5 mm / 66 mm / 64 mm		
Wire strip length	8 mm		
Approvals	  		
TECHNICAL DATA	IEC	UL	CSA
	EN 60 947-7-1		
Cross section fine-stranded	0.14 – 2.5 mm ²		
Cross section solid/stranded	0.2 – 4 mm ²		
Cross section, AWG	22 – 12		24 – 12
Rated current	24 A	20 A	25 A
Rated voltage	500 V	600 V	600 V
Rated impulse voltage	6 A		
Pollution degree	3		

WKN 2,5 E/U/VB

- Multi-tier block, vertically jumpered, with screw connection for mounting on TS 35 and TS 32
- Nominal cross section 2.5 mm²
- Class I, Zone 1, AEx, e, II, T6



Description	Type	Part No.	Std. Pack
Multi-tier block	black WKN 2,5 E/U/VB	57.403.6955.1	100
GENERAL DATA			
Width / length / height, incl. TS 7.5	5 mm / 66 mm / 64 mm		
Wire strip length	8 mm		
Approvals	  		
TECHNICAL DATA	IEC	UL	CSA
	EN 60 947-7-1		
Cross section fine-stranded	0.14 – 2.5 mm ²		
Cross section solid/stranded	0.2 – 4 mm ²		
Cross section, AWG	22 – 12		24 – 12
Rated current	24 A	20 A	25 A
Rated voltage	500 V	600 V	600 V
Rated impulse voltage	6 A		
Pollution degree	3		

ACCESSORIES FOR SELOS WKN 2,5 E/U

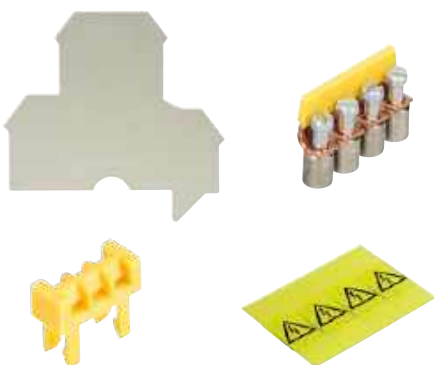

ACCESSORIES	Type	Part No.	Std. Pack
End plate	gray APN 2,5 E	07.312.1755.0	10
Partition	gray TWN 2,5 E	07.312.1855.0	10
Cross connector with screws, insulated	2-pole IVB WK 2,5 - 2	Z7.280.2227.0	10
	3-pole IVB WK 2,5 - 3	Z7.280.2327.0	10
	up to 12-pole IVB WK 2,5 - 12	Z7.280.3227.0	10
Partition plate with marking facility	yellow TS 2,5 GELB	07.311.2053.8	10
Single cover with marking facility	yellow AD VB 2,5 GELB	04.326.2053.8	10
Cover with warning symbol over 4 blocks		04.343.4756.8	10

WT 4 E

- Multi-tier block for mounting on TS 35
- Nominal cross section 4 mm²
-  II 2G 2D Ex eb IIC
Follow the EX installation instructions on page 160
- Connection capacity: 2 wires, equal size
0.14 – 2.5 mm²



Description	Type	Part No.	Std. Pack
Multi-tier block	gray WT 4 E	58.504.7055.0	100
Multi-tier block	blue WT 4 E BL	58.504.7055.6	100

GENERAL DATA			
Width / length / height, incl. TS 7.5	6 mm / 72 mm / 67 mm		
Wire strip length	9 mm		
Approvals	 ATEX IECEx IEC Ex SEV 14.0004 U SEV 14 ATEX 0124 U		

TECHNICAL DATA	IEC	UL	CSA	
	EN 60 947-7-1			IEC/EN 60 079-0/-7
Cross section fine-stranded	0.14 – 6 mm ²			0.14 – 6 mm ²
Cross section solid/stranded	0.14 – 6 mm ²			0.14 – 6 mm ²
Cross section, AWG		26 – 10	26 – 10	
Rated current	32 A	30 A	30 A	32 A
Rated voltage	800 V	300 V	300 V	550 V
Rated impulse voltage	8 kV			
Pollution degree	3			

ACCESSORIES	Type	Part No.	Std. Pack
End plate	AP WT 4 E	07.313.3355.0	10
Partition	TW WT 4 E	07.313.2855.0	10
Cross connector	2-pole	IVB WKF 4-2	10
	3-pole	IVB WKF 4-3	10
	4-pole	IVB WKF 4-4	10
	5-pole	IVB WKF 4-5	10
	10-pole	IVB WKF 4-10	10

WT 4 E VB

- Multi-tier block, vertically jumpered, with screw connection for mounting on TS 35
- Nominal cross section 4 mm²
-  II 2G 2D Ex eb IIC
Follow the EX installation instructions on page 160
- Connection capacity: 2 wires, equal size
0.14 – 2.5 mm²



Description	Type	Part No.	Std. Pack
Multi-tier block	black WT 4 E VB	58.504.6955.1	100

GENERAL DATA			
Width / length / height, incl. TS 7.5	6 mm / 72 mm / 67 mm		
Wire strip length	9 mm		
Approvals	 ATEX IECEx IEC Ex SEV 14.0004 U SEV 14 ATEX 0124 U		

TECHNICAL DATA	IEC	UL	CSA	
	EN 60 947-7-1			IEC/EN 60 079-0/-7
Cross section fine-stranded	0.14 – 6 mm ²			0.14 – 6 mm ²
Cross section solid/stranded	0.14 – 6 mm ²			0.14 – 6 mm ²
Cross section, AWG		26 – 10	26 – 10	
Rated current	32 A	30 A	30 A	32 A
Rated voltage	800 V	300 V	300 V	550 V
Rated impulse voltage	8 kV			
Pollution degree	3			

ACCESSORIES	Type	Part No.	Std. Pack
End plate	AP WT 4 E	07.313.3355.0	10
Partition	TW WT 4 E	07.313.2855.0	10
Cross connector	2-pole	IVB WKF 4-2	10
	3-pole	IVB WKF 4-3	10
	4-pole	IVB WKF 4-4	10
	5-pole	IVB WKF 4-5	10
	10-pole	IVB WKF 4-10	10

WT 4 E PE

- Multi-tier ground block with screw connection for mounting on TS 35
- Nominal cross section 4 mm²
-  II 2G 2D Ex eb IIC
Follow the EX installation instructions on page 160
- Connection capacity: 2 wires, equal size
0.14 – 2.5 mm²



Description	Type	Part No.	Std. Pack
Multi-tier ground block	green/yellow WT 4 E PE	58.504.9255.0	100

GENERAL DATA			
Width / length / height, incl. TS 7.5	6 mm / 72 mm / 67 mm		
Wire strip length	9 mm		
Approvals	 ATEX IECEx IEC Ex SEV 14.0004 U SEV 14 ATEX 0124 U		

TECHNICAL DATA	IEC	UL	CSA	
	EN 60 947-7-2			IEC/EN 60 079-0/-7
Cross section fine-stranded	0.14 – 6 mm ²			0.14 – 6 mm ²
Cross section solid/stranded	0.14 – 6 mm ²			0.14 – 6 mm ²
Cross section, AWG		26 – 10		
Rated current				
Rated voltage	800 V		300 V	
Rated impulse voltage	8 kV			
Pollution degree	3			

ACCESSORIES	Type	Part No.	Std. Pack
End plate	AP WT 4 E	07.313.3355.0	10

SELOS · SPECIALTY FUNCTION BLOCKS WITH SCREW CONNECTION

WT 4 E...

- Function block with screw connection for mounting on TS 35
- Nominal cross section 4 mm²
- Connection capacity: 2 wires, equal size 0.14 – 2.5 mm²

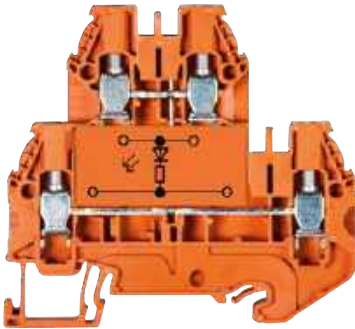

Description	Type	Part No.	Std. Pack
Function block	orange WT 4 E...	58.504.XX55.9	100

GENERAL DATA

Width / length / height, incl. TS 7.5	6 mm / 72 mm / 67 mm
Wire strip length	9 mm
Approvals	

TECHNICAL DATA

IEC	UL	CSA
EN 60 947-7-1/-2		
Cross section fine-stranded	0.14 – 6 mm ²	
Cross section solid/stranded	0.14 – 6 mm ²	
Cross section, AWG	26 – 10	26 – 10
Rated current		
Rated voltage		
Rated impulse voltage		
Pollution degree		

ACCESSORIES

Description	Type	Part No.	Std. Pack
End plate	gray AP WT 4 E	07.313.3355.0	10

EXAMPLES OF FUNCTIONS

The multi-tier block is as a function block for a wide variety of switch tasks on request, more details can be found in the e-shop.

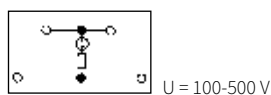
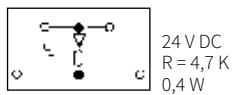
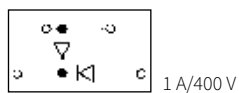
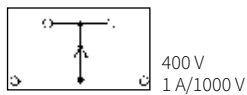
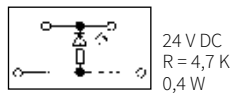
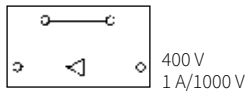

SELOS · THREE-TIER- / INITIATOR BLOCKS WITH SCREW CONNECTION

WK 2,5-3 D/U

- Multi-tier block for mounting on TS 35 and TS 32
- Nominal cross section 2,5 mm²



WK 2,5 - 3 D/U-NGN

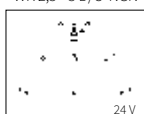

WK 2,5 - 3 D/U-PGN



Description	Type	Part No.	Std. Pack
Multi-tier block	gray WK 2,5 - 3 D/U	57.503.8855.0	50
Multi-tier bl., LED (green) betw. signal and +	WK 2,5 - 3 D/U-NGN	57.503.8955.0	50
Multi-tier bl., LED (green) betw. signal and -	WK 2,5 - 3 D/U-PGN	57.503.9055.0	50

GENERAL DATA			
Width / length / height, incl. TS 7.5	6 mm / 79 mm / 69 mm		
Wire strip length	7 mm		
Approvals			

TECHNICAL DATA	IEC	UL	CSA
	EN 60 947-7-1		
Cross section fine-stranded	0.5 - 2.5 mm ²		
Cross section solid/stranded	0.5 - 4 mm ²		
Cross section, AWG		22 - 12	22 - 12
Rated current	24 A	25 A	25 A
Rated voltage	400 V*	300 V*	300 V*
Rated impulse voltage	6 kV		
Pollution degree	3		

ACCESSORIES	Type	Part No.	Std. Pack
Partition	gray TW 2,5 - 3 D/U	07.312.1255.0	50

WK 2,5-3 D/SL

- Multi-tier block for mounting on TS 35
- Nominal cross section 2,5 mm²

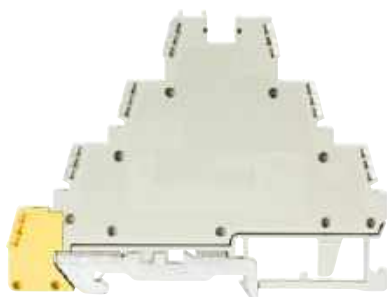

WK 2,5 - 3 D SL-NGN



WK 2,5 - 3 D SL-PGN

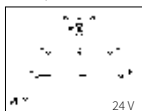

Description	Type	Part No.	Std. Pack
Multi-tier block	gray WK 2,5 - 3 D SL	56.503.8355.0	50
Multi-tier bl., LED (green) betw. signal and +	WK 2,5 - 3 D SL-NGN	56.503.8455.0	50
Multi-tier bl., LED (green) betw. signal and -	WK 2,5 - 3 D SL-PGN	56.503.8555.0	50

GENERAL DATA			
Width / length / height, incl. TS 7.5	6 mm / 79 mm / 69 mm		
Wire strip length	7 mm		
Approvals			

TECHNICAL DATA	IEC	UL	CSA
	EN 60 947-7-1		
Cross section fine-stranded	0.5 - 2.5 mm ²		
Cross section solid/stranded	0.5 - 4 mm ²		
Cross section, AWG		22 - 12	22 - 12
Rated current	24 A	25 A	25 A
Rated voltage	400 V*	300 V*	300 V*
Rated impulse voltage	6 kV		
Pollution degree	3		

ACCESSORIES	Type	Part No.	Std. Pack
Partition	gray TW 2,5 - 3 D/U	07.312.1255.0	50

ACCESSORIES FOR SELOS WK 2,5-3 D

- The use of cross connectors (jumper combs), requires partitions in order to maintain the air and creepage distances.
- *24 V_{nom} with LED



ACCESSORIES	Type	Part No.	Std. Pack	
Cross connector with screws, insulated, for upper level	2-pole	IVB WK/3D-02	Z7.270.0227.0	10
	3-pole	IVB WK/3D-03	Z7.270.0327.0	10
	up to 12-pole	IVB WK/3D-12	Z7.270.1227.0	10
Jumper comb, angled, insulated (red), for lower level	2-pole	IVB WK 2,5-K-2 ROT	Z7.267.0227.5	10
	3-pole	IVB WK 2,5-K-3 ROT	Z7.267.0327.5	10
	up to 12-pole	IVB WK 2,5-K-12 ROT	Z7.267.1227.5	10
Jumper comb, angled, insulated (blue), for lower level	2-pole	IVB WK 2,5-K-2 BLAU	Z7.267.0227.6	10
	3-pole	IVB WK 2,5-K-3 BLAU	Z7.267.0327.6	10
	up to 12-pole	IVB WK 2,5-K-12 BLAU	Z7.267.1227.6	10

SELOS · INITIATOR BLOCKS WITH SCREW CONNECTION

WK 2,5-4 KI / U

- Initiator block with screw connection for mounting on TS 35 and TS 32
- Nominal cross section 2.5 mm²

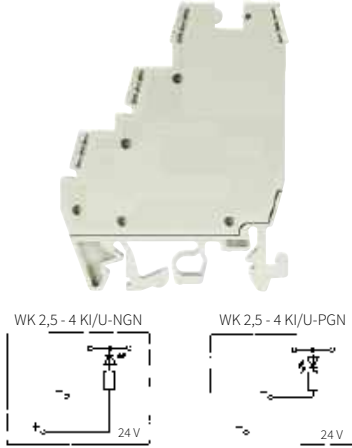

Description	Type	Part No.	Std. Pack
Initiator block	gray WK 2,5 - 4 KI/U	57.503.7855.0	100
Multi-tier bl., LED (green) betw. signal and +	WK 2,5 - 4 KI/U-NGN	57.503.7955.0	100
Multi-tier bl., LED (green) betw. signal and -	WK 2,5 - 4 KI/U-PGN	57.503.8055.0	100

GENERAL DATA			
Width / length / height, incl. TS 7.5	6 mm / 53 mm / 69 mm		
Wire strip length	7 mm		
Approvals			

TECHNICAL DATA			
	IEC	UL	CSA
	EN 60 947-7-1		
	DIN VDE 0611 T1		
Cross section fine-stranded	0.5 - 2.5 mm ²		
Cross section solid/stranded	0.5 - 4 mm ²		
Cross section, AWG		22 - 12	22 - 12
Rated current	24 A	25 A	25 A
Rated voltage	250 V*	300 V*	300 V*
Rated impulse voltage	4 kV		
Pollution degree	3		

ACCESSORIES			
Partition	gray TW 2,5 - 4 K/U	07.312.0555.0	10

WK 2,5-4 KI / SL

- Initiator block with screw connection for mounting on TS 35
- Nominal cross section 2.5 mm²

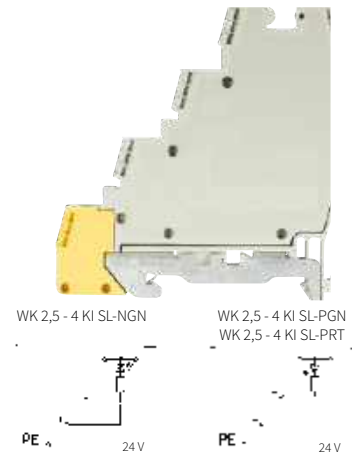

Description	Type	Part No.	Std. Pack
Initiator block	gray WK 2,5 - 4 KI SL	56.503.7355.0	100
Multi-tier bl., LED (green) betw. signal and +	WK 2,5 - 4 KI SL-NGN	56.503.7455.0	100
Multi-tier bl., LED (green) betw. signal and -	WK 2,5 - 4 KI SL-PGN	56.503.7555.0	100
Multi-tier bl., LED (red) betw. signal and -	WK 2,5 - 4 KI SL-PRT	56.503.7655.0	100

GENERAL DATA			
Width / length / height, incl. TS 7.5	6 mm / 64 mm / 69 mm		
Wire strip length	7 mm		
Approvals			

TECHNICAL DATA			
	IEC	UL	CSA
	EN 60 947-7-1		
	DIN VDE 0611 T1		
Cross section fine-stranded	0.5 - 2.5 mm ²		
Cross section solid/stranded	0.5 - 4 mm ²		
Cross section, AWG		22 - 12	22 - 12
Rated current	24 A	25 A	25 A
Rated voltage	250 V*	300 V*	300 V*
Rated impulse voltage	4 kV		
Pollution degree	3		

ACCESSORIES			
Partition	gray TW 2,5 - 4 K/U	07.312.0555.0	10

ACCESSORIES FOR SELOS WK 2,5-4 KI

- The use of cross connectors (jumper combs), requires partitions in order to maintain the air and creepage distances.
- *24 V_~ with LED



ACCESSORIES				
Cross connector with screws, insulated, for upper level	2-pole	IVB WK/3D-02	Z7.270.0227.0	10
	3-pole	IVB WK/3D-03	Z7.270.0327.0	10
	up to 12-pole	IVB WK/3D-12	Z7.270.1227.0	10
Jumper comb, angled, insulated (red), for lower level	2-pole	IVB WK 2,5-K-2 ROT	Z7.267.0227.5	10
	3-pole	IVB WK 2,5-K-3 ROT	Z7.267.0327.5	10
	up to 12-pole	IVB WK 2,5-K-12 ROT	Z7.267.1227.5	10
Jumper comb, angled, insulated (blue), for lower level	2-pole	IVB WK 2,5-K-2 BLAU	Z7.267.0227.6	10
	3-pole	IVB WK 2,5-K-3 BLAU	Z7.267.0327.6	10
	up to 12-pole	IVB WK 2,5-K-12 BLAU	Z7.267.1227.6	10

WK 2,5-4 KOI / U

- Initiator block with screw connection for mounting on TS 35 and TS 32
- Nominal cross section 2.5 mm²



Description	Type	Part No.	Std. Pack
Initiator block	gray WK 2,5-4 KOI/U	57.503.7055.0	50

GENERAL DATA

Width / length / height, incl. TS 7.5	5 mm / 92 mm / 45 mm
Wire strip length	10 mm
Approvals	

TECHNICAL DATA

IEC	UL	CSA
EN 60 947-7-1		
Cross section fine-stranded	0.5 – 2.5 mm ²	
Cross section solid/stranded	0.5 – 4 mm ²	
Cross section, AWG	22 – 12	22 – 12
Rated current, feed-through	16 A	20/30 A
Rated voltage	400 V	300 V
Rated impulse voltage	6 kV	300 V
Pollution degree	3	

ACCESSORIES

Description	Type	Part No.	Std. Pack
Cross connector with screws, for signal feed through	2-pole VB WK 2,5-2	Z7.280.0227.0	10
	3-pole VB WK 2,5-3	Z7.280.0327.0	10
	up to 6-pole VB WK 2,5-6	Z7.280.0627.0	10

WK 2,5-4 KOI / U-NGN

WK 2,5-4 KOI / U-PGN

- Initiator block with screw connection for mounting on TS 35 and TS 32
- **NGN:** With LED (green) between signal and plus
- **PGN:** Wit LED (green) between signal and minus
- Nominal cross section 2.5 mm²



DESCRIPTION

Description	Type	Part No.	Std. Pack
Initiator block	gray WK 2,5-4 KOI/U-NGN	57.503.7155.0	50
Initiator block	gray WK 2,5-4 KOI/U-PGN	57.503.7255.0	50

GENERAL DATA

Width / length / height, incl. TS 7.5	5 mm / 92 mm / 45 mm
Wire strip length	10 mm
Approvals	

TECHNICAL DATA

IEC	UL	CSA
EN 60 947-7-1		
Cross section fine-stranded	0.5 – 2.5 mm ²	
Cross section solid/stranded	0.5 – 4 mm ²	
Cross section, AWG	22 – 12	22 – 12
Rated current, feed-through	16 A	20/30 A
Rated voltage	24 DC	24 V
Rated impulse voltage		24 V
Pollution degree		

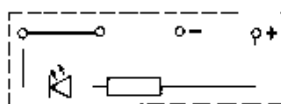

NGN: Indicator: R = 2.2 K 0,35 W
Lamp color: green

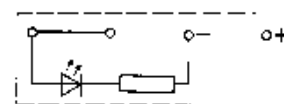

PGN: Indicator: R = 2.2 K 0,35 W
Lamp color: green

ACCESSORIES FOR SELOS WK 2,5-4 KOI/U

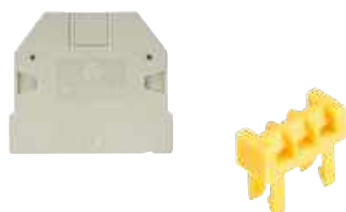

ACCESSORIES

Description	Type	Part No.	Std. Pack
End plate	gray AP 2,5-4 KO	07.310.9355.0	50
Partition	gray TW 2,5-4 KO	07.310.9455.0	50
Cross connector for voltage supply	2-pole VB WK 2,5 KO-2	07.257.0227.0	100
	3-pole VB WK 2,5 KO-3	07.257.0327.0	100
	up to 20-pole VB WK 2,5 KO-20	07.257.2027.0	50
Partition plate with marking facility	yellow TS 2,5 GELB	07.311.2053.8	10
Single cover with marking facility	yellow AD VB 2,5 GELB	04.326.2053.8	10
Cover strip for cross connectors over 10 blocks	AD VB 5/10	04.342.0556.0	10
Tear-off marking strip, red, marked "+"	red 9705 A/5/10 B + ROT	04.855.0253.5	25
Tear-off marking strip, blue, marked "-"	blue 9705 A/5/10 B - BLAU	04.855.0353.6	25

SELOS · FUSE BLOCKS WITH SCREW CONNECTION

WK 4 TKG... WITH THSI 5X20

- Disconnect base block with screw connection for mounting on TS 35 and TS 32
- Nominal cross section 4 mm²



Description	Type	Part No.	Std. Pack
Disconnect base block	gray WK 4 TKG/U	57.504.4055.0	100
Fuse disconnect lever	gray THSI 5x20	Z1.298.1053.0	10
Fuse disconnect lever with LED 12 - 24 V ²⁾	THSI 5x20 LED24	Z1.298.1153.0	10
Fuse disconnect lever with LED 24 - 60 V ²⁾	THSI 5x20 LED60	Z1.298.1253.0	10
Fuse disconnect lever with GL 110 - 250 V ²⁾	THSI 5x20 GL250	Z1.298.1353.0	10

GENERAL DATA			
Width / length / height, incl. TS 7.5	6 mm / 48 mm / 81 mm		
Wire strip length	9 mm		
Approvals			
TECHNICAL DATA			
	IEC	UL	CSA
	EN 60947-7-1, EN 60127-6		
Cross section fine-stranded	0.5 - 4 mm ²		
Cross section solid/stranded	0.5 - 6 mm ²		
Cross section, AWG		22 - 10	20 - 10
Rated current	¹⁾	10 A ¹⁾	6.3 A ¹⁾
Rated voltage	690 V ²⁾	300 V ²⁾	250 V ²⁾
Rated impulse voltage	6 kV		
Pollution degree	3		

WK 4 TKG... WITH THSI 6,3X32

- Disconnect base block with screw connection for mounting on TS 35 and TS 32
- Nominal cross section 4 mm²



Description	Type	Part No.	Std. Pack
Disconnect base block	gray WK 4 TKG/U	57.504.4055.0	100
Fuse disconnect lever	gray THSI 6,3x32	Z1.298.1653.0	10
Fuse disconnect lever with LED 12 - 24 V ²⁾	THSI 6,3x32 LED24	Z1.298.1753.0	10
Fuse disconnect lever with LED 24 - 60 V ²⁾	THSI 6,3x32 LED60	Z1.298.1853.0	10
Fuse disconnect lever with GL 110 - 250 V ²⁾	THSI 6,3x32 GL250	Z1.298.1953.0	10

GENERAL DATA			
Width / length / height, incl. TS 7.5	6 mm / 48 mm / 81 mm		
Width disconnect lever THSI 6.3x32	8 mm	use end plate 07.311.6155.0 to maintain pitch	
Wire strip length	9 mm		
Approvals			
TECHNICAL DATA			
	IEC	UL	CSA
	EN 60947-7-1, EN 60127-6		
Cross section fine-stranded	0.5 - 4 mm ²		
Cross section solid/stranded	0.5 - 6 mm ²		
Cross section, AWG		22 - 10	20 - 10
Rated current	¹⁾	10 A ¹⁾	6.3 A ¹⁾
Rated voltage	690 V ²⁾	300 V ²⁾	250 V ²⁾
Rated impulse voltage	6 kV		
Pollution degree	3		

TECHNICAL INFORMATION:

¹⁾ When selecting G fuse inserts, make sure that the specified maximum power loss is not exceeded. The current is determined by the inserted fuse.

Maximum power loss at 23°C ambient temperature (according to DIN EN 60947-7-3)

Type	Rated Voltage	Overload protection		Exclusive short-circuit protection	
		Single arrangement	Group arrangement	Single arrangement	Group arrangement
THSI 5x20	250V	2.5W	1.6W	4.0W	2.5W
THSI 6,3x32	500V	2.5W	1.6W	4.0W	4.0W
SIST	250V	2.5W	1.6W	2.5W	2.5W

²⁾ The voltage range is determined by the built-in LED display.

Depending on the application and the installation method, the possibility of increased temperature must be checked in the closed fuse holders.

Higher ambient temperatures mean additional stress for the fuse inserts. Therefore, the reduction of the rated current must be considered accordingly in these applications.

Indicator (24V): Lamp color: red
Power consumption: 10.3 mA

Indicator (220V): Lamp color: red
Power consumption: 0.3 mA

WK 4 TKG... SIST

- Disconnect base block with screw connection for mounting on TS 35 and TS 32
- Nominal cross section 4 mm²



Description	Type	Part No.	Std. Pack
Disconnect base block	gray WK 4 TKG/U	57.504.4055.0	100
Fuse holder for 5x20 fuse	Si ST	Z1.299.4055.0	10
Fuse holder with LED 24-60V	Si ST LED	Z1.299.4155.0	10
Fuse holder with GL 220V	Si ST GL	Z1.299.4255.0	10

GENERAL DATA			
Width / length / height, incl. TS 7.5	6 mm / 48 mm / 68 mm		
Wire strip length	9 mm		
Approvals			
TECHNICAL DATA		IEC	UL
		EN 60947-7-1, EN 60127-6	CSA
Cross section fine-stranded	0.5 – 4 mm ²		
Cross section solid/stranded	0.5 – 6 mm ²		
Cross section, AWG		22 – 10	20 – 10
Rated current	¹⁾	10 A	6.3 A ¹⁾
Rated voltage	690 V ²⁾	300 V	250 V
Rated impulse voltage	6 kV		
Pollution degree	3		

WK 4 TKG... DIST

- Disconnect base block with screw connection for mounting on TS 35 and TS 32
- Nominal cross section 4 mm²



Description	Type	Part No.	Std. Pack
Disconnect base block	gray WK 4 TKG/U	57.504.4055.0	100
Diode plug - without contacts	DIST ...	Z1.299.3055.0	10
Diode plug - diode	I _{max} = 1 A DIST-1 N 4007-1 ³⁾	Z1.299.3155.0	10
Diode plug - diode	I _{max} = 1 A DIST-1 N 4007-2 ⁴⁾	Z1.299.3355.0	10
Diode plug with jumper	I _{max} = 10 A DIST-D	Z1.299.3255.0	10

GENERAL DATA			
Width / length / height, incl. TS 7.5	6 mm / 48 mm / 68 mm		
Wire strip length	9 mm		
Approvals			
TECHNICAL DATA		IEC	UL
		EN 60947-7-1, EN 60127-6	CSA
Cross section fine-stranded	0.5 – 4 mm ²		
Cross section solid/stranded	0.5 – 6 mm ²		
Cross section, AWG		22 – 10	20 – 10
Rated current		10 A	6.3 A ¹⁾
Rated voltage	690 V ²⁾	300 V	250 V
Rated impulse voltage	6 kV		
Pollution degree	3		

The current carrying load depends on the component used.
 Temporary peak voltage 1000 V.
 Pole assignment of the diode: Anode Cathode³⁾ Cathode⁴⁾ Anode⁴⁾

ACCESSORIES FOR SELOS WK 4 TKG WITH THSI 5, SIST AND DIST

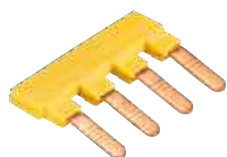

ACCESSORIES	Type	Part No.	Std. Pack
End plate	gray AP 4 TK	07.311.6155.0	10
Partition	gray TW 4 TK	07.311.8155.0	10
Jumper comb, insulated	2-pole	IVB 1 WK 4..-2	10
	3-pole	IVB 1 WK 4..-3	10
	up to 6-pole	IVB 1 WK 4..-6	10

SELOS · FUSE- AND KNIFE EDGE DISCONNECT BLOCKS WITH SCREW CONNECTION

WK 4/SI-D/U 5X25

- Fuse block with screw connection for mounting on TS 35 and TS 32
- Nominal cross section 4 mm²



Description	Type	Part No.	Std. Pack
Fuse block	gray		
w. G-screw cap B DIN 41674, 5x25 mm	WK 4/SI-D/U 5 x 25	57.504.1655.0	50
w. G-SG-screw cap A DIN 41674, 5x20 mm	WK 4/SI-D/U 5 x 20	57.504.1755.0	50

GENERAL DATA			
Width / length / height, incl. TS 7.5	12 mm / 48 mm / 49 mm		
Wire strip length	9 mm		
Approvals			

TECHNICAL DATA		IEC	UL	CSA
		EN 60947-7-1, EN 60127-6		
Cross section fine-stranded	0.5 – 4 mm ²			
Cross section solid/stranded	0.5 – 6 mm ²			
Cross section, AWG			22 – 10	
Rated current	6.3 A		10 A	
Rated voltage	690 V		250 V	
Rated impulse voltage	6 kV			
Pollution degree	3			

ACCESSORIES		Type	Part No.	Std. Pack
End plate	gray	AP 4 TK	07.311.6155.0	10
Partition	gray	TW 4 TK	07.311.8155.0	10
Jumper comb, insulated	2-pole	IVB 1 WK 4..-2	Z7.255.4227.0	10
	3-pole	IVB 1 WK 4..-3	Z7.255.4327.0	10
	up to 6-pole	IVB 1 WK 4..-6	Z7.255.4627.0	10

WK 4/TKM

- Knife edge disconnect block with screw connection for mounting on TS 35 and TS 32
- Nominal cross section 4 mm²
- **Version with test bolt:** CSA: 300V
EN 60947-7-1 – 400V/4kV/3
Test bolt can be loaded with 1A



Description	Type	Part No.	Std. Pack
Knife edge disconnect block	gray	WK 4/TKM/U	57.504.2055.0
Knife edge disconnect block with 2 test bolts*	blue	WK 4/TKM/U BLAU	57.504.2055.6
	gray	WK 4/TKM/P3/U	57.504.2355.0

GENERAL DATA			
Width / length / height, incl. TS 7.5	6 mm / 48 mm / 49 mm		
Wire strip length	9 mm		
Approvals			

TECHNICAL DATA		IEC	UL	CSA
		EN 60947-7-1, EN 60127-6		
Cross section fine-stranded	0.5 – 4 mm ²			
Cross section solid/stranded	0.5 – 6 mm ²			
Cross section, AWG			22 – 10	22 – 10
Rated current	20 A		20 A	20 A
Rated voltage	690 V		600 V	600 V
Rated impulse voltage	6 kV			
Pollution degree	3			

ACCESSORIES		Type	Part No.	Std. Pack
End plate	gray	AP 4 TK	07.311.6155.0	10
Partition	gray	TW 4 TK	07.311.8155.0	10
Jumper comb, insulated	2-pole	IVB 1 WK 4..-2	Z7.255.4227.0	10
	3-pole	IVB 1 WK 4..-3	Z7.255.4327.0	10
	up to 6-pole	IVB 1 WK 4..-6	Z7.255.4627.0	10

WK 4 TKG-TRST/U

- Invertible plug disconnect block with screw connection for mounting on TS 35 and 42
- Nominal cross section 4 mm²
- **Version with test bolt:** CSA: 300V
EN 60947-7-1 – 400V/4kV/3
Test bolt can be loaded with 1A



Description	Type	Part No.	Std. Pack
Invertible plug disconnect block	gray	WK 4 TKG-TRST/U	57.504.4555.0
with 2 test bolts, gray*		WK 4 TKG-TRST P3/U	57.504.4855.0

GENERAL DATA			
Width / length / height, incl. TS 7.5	6 mm / 48 mm / 78 mm		
Wire strip length	9 mm		
Approvals			

TECHNICAL DATA		IEC	UL	CSA
		EN 60947-7-1, EN 60127-6		
Cross section fine-stranded	0.5 – 4 mm ²			
Cross section solid/stranded	0.5 – 6 mm ²			
Cross section, AWG			22 – 10	22 – 10
Rated current	20 A		10 A	20 A
Rated voltage	690 V		300 V	600 V
Rated impulse voltage	6 kV			
Pollution degree	3			

ACCESSORIES		Type	Part No.	Std. Pack
End plate	gray	AP 4 TK	07.311.6155.0	10
Partition	gray	TW 4 TK	07.311.8155.0	10
Jumper comb, insulated	2-pole	IVB 1 WK 4..-2	Z7.255.4227.0	10
	3-pole	IVB 1 WK 4..-3	Z7.255.4327.0	10
	up to 6-pole	IVB 1 WK 4..-6	Z7.255.4627.0	10

More accessories page 130 ff.

SELOS · FUNCTION BLOCKS WITH SCREW CONNECTION

9786 U/12

- Function block with screw connection for mounting on TS 35 and TS 32
- Nominal cross section 2.5 mm²



Description	Type	Part No.	Std. Pack
Function block empty	9786 U/12	57.904.2055.0	50
with bridge rectifier B380 C1500	9786 U/12 G4	57.904.2555.0	50
with optocoupler CNY 17/3	9786 U/12 OPK	57.904.2855.0	50

GENERAL DATA	
Width / length / height, incl. TS 7.5	12 mm / 52 mm / 58 mm
Wire strip length	9 mm
Approvals	

TECHNICAL DATA	IEC	UL	CSA
	EN 60947-7-1		
Cross section fine-stranded	0.5 – 2.5 mm ²		
Cross section solid/stranded	0.5 – 2.5 mm ²		
Cross section, AWG		22 – 14	22 – 14
Rated current	24 A	6 A	6 A
Rated voltage	800 V	300 V	300 V
Rated impulse voltage	8 kV		
Pollution degree	3		



9760 U/8

- Ground disconnect with screw connection for mounting on TS 35 and TS 32
- Nominal cross section 6 mm²



Description	Type	Part No.	Std. Pack
Ground disconnect 24-48V \cong with LED	9760 U/8 TKE 48	57.110.1655.0	25
110-220V \cong with indicator lamp	9760 U/8 TKE 220	57.110.1555.0	25

GENERAL DATA	
Width / length / height, incl. TS 7.5	17,5 mm / 71 mm / 52 mm
Wire strip length	9 mm
Approvals	

TECHNICAL DATA	IEC	CSA
	EN 60947-7-1	
Cross section fine-stranded	1.0 – 10 mm ²	
Cross section solid/stranded	1.0 – 10 mm ²	
Cross section, AWG		18 – 8
Rated current	30 A	25 A
Rated voltage	24 – 48 V / 110 – 220 V	48 V / 220 V
Rated impulse voltage		
Pollution degree		

Ground Disconnect terminal with LED 24-48V \cong

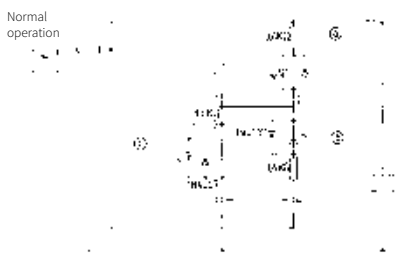

- (a) external status display lights up
- (b) green status display lights up
- (c) red ground-fault indicator lights up

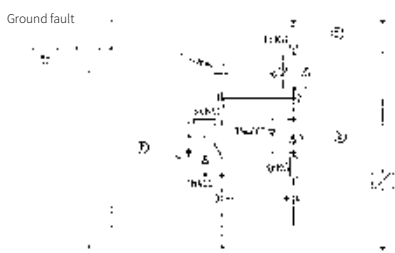

- (d) external status display lights up
- (e) green status display lights up
- (f) red ground-fault indicator lights up

Ground Disconnect terminal with Neon Lamp 110-220V \cong

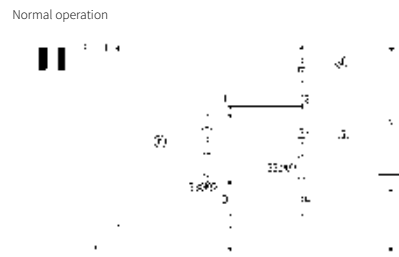

- (g) yellow status display lights up



- (h) yellow indicator light not flashing

Technical information see FACTS & DATA page 158 ff.

Subject to technical modifications

SELOS · FUSE BLOCKS WITH SCREW CONNECTION

WK 4 THSi 5... /U

- Integrated lever-action fuse block with screw connection for mounting on TS 35 and TS 32
- Nominal cross section 4 mm²
- For 5 mm miniature fuses
- The standard block has a storage location for a replacement fuse.



Description	Type	Part No.	Std. Pack
Fuse block	gray WK 4/THSi 5 ... U	57.904.5355.0	50
- with LED 5-12V-/s	current consumed. 2.3-7mA WK 4/THSi 5 LED 12 U	57.904.5455.0	50
- with LED 12-24V-/s	current con. 2.8-6.2mA WK 4/THSi 5 LED 24 U	57.904.5555.0	50
- with LED 24-60V-/s	current con. 1.5-4mA WK 4/THSi 5 LED 60 U	57.904.5655.0	50
- with GL 110-250V-/s	current con. 0.13-0.55mA WK 4/THSi 5 GL 250 U	57.904.5755.0	50
- with GL 380-500V-/s	current con. 0.2-0.3mA WK 4/THSi 5 GL 500 U	57.904.5855.0	50

GENERAL DATA				
Width / length / height, incl. TS 7.5	8 mm / 77 mm / 54 mm			
Wire strip length	8 mm			
Approvals				
TECHNICAL DATA		IEC	UL	CSA
		EN 60947-7-1, EN 60127-6		
Cross section fine-stranded	0,5 – 4 mm ²			
Cross section solid/stranded	0,5 – 6 mm ²			
Cross section, AWG	22 – 10		22 – 10	
Rated current	6.3 A ¹⁾	15 A	6.3 A	
Rated voltage	800 V ²⁾	600 V ²⁾	600 V ²⁾	
Rated impulse voltage	8 kV			
Pollution degree	3			

WK 4 THSi 6,3... /U

- Integrated lever-action fuse block with screw connection for mounting on TS 35 and TS32
- Nominal cross section 4 mm²
- For 6.3 mm miniature fuses
- The standard block has a storage location for a replacement fuse.



Description	Type	Part No.	Std. Pack
Fuse block	gray WK 4/THSi 6,3 ... U	57.904.6355.0	50
- with LED 5-12V-/s	current consumed. 2.3-7mA WK 4/THSi 6,3 LED 12 U	57.904.6455.0	50
- with LED 12-24V-/s	current con. 2.8-6.2mA WK 4/THSi 6,3 LED 24 U	57.904.6555.0	50
- with LED 24-60V-/s	current con. 1.5-4mA WK 4/THSi 6,3 LED 60 U	57.904.6655.0	50
- with GL 110-250V-/s	current con. 0.13-0.55mA WK 4/THSi 6,3 GL 250 U	57.904.6755.0	50
- with GL 380-500V-/s	current con. 0.2-0.3mA WK 4/THSi 6,3 GL 500 U	57.904.6855.0	50

GENERAL DATA				
Width / length / height, incl. TS 7.5	10 mm / 77 mm / 54 mm			
Wire strip length	8 mm			
Approvals				
TECHNICAL DATA		IEC	UL	CSA
		EN 60947-7-1, EN 60127-6		
Cross section fine-stranded	0,5 – 4 mm ²			
Cross section solid/stranded	0,5 – 6 mm ²			
Cross section, AWG	22 – 10		22 – 10	
Rated current	10 A ¹⁾	15 A	10 A	
Rated voltage	800 V ²⁾	600 V ²⁾	600 V ²⁾	
Rated impulse voltage	8 kV			
Pollution degree	3			

TECHNICAL INFORMATION FOR SELOS WK 4 THSi

The fuse blocks of this type have a flip top disconnect lever. It accepts miniature fuses of 5x20, 5x25 and 5x30 mm (terminal width: 8 mm) or 6.3x32 mm (terminal width: 10 mm). The hinged lever has latch points both in the open and in the closed position, and can be sealed.

All terminal blocks are available in two different versions, i.e. with or without red LEDs functioning as indicators.

¹⁾ When selecting G fuse inserts, make sure that the specified maximum power loss is not exceeded. The current is determined by the inserted fuse.

²⁾ The voltage range is determined by the built-in LED display.

Depending on the application and the installation method, the circumstances for increased temperature must be checked in the closed fuse holders. Higher ambient temperatures are an additional load for the fuse inserts. Therefore, the reduction of the rated current must be considered accordingly in these applications.

¹⁾ Maximum power loss at 23° C ambient temperature (according to DIN EN 60947-7-3)

Type	Rated voltage	Overload protection		Exclusive short-circuit protection	
		Single arrangement	Group arrangement	Single arrangement	Group arrangement
THSi 5x20/25	250V	1.6W	1.6W	4.0W	2.5W
THSi 6,3x32	500V	2.5W	2.5W	4.0W	2.5W
THSi 5x30	500V	1.6W	1.6W	4.0W	2.5W

WK 10/SI .../U

- Fuse block with screw cap for mounting on TS 35
- Nominal cross section 10 mm²

* Voltage and current are determined by the built-in LED and the inserted G-fuse.



Description	Type	Part No.	Std. Pack
Fuse block, with screw cap	gray		
- A DIN 41674 for G-fuses DIN 41571	WK 10/Si U 5 x 20	57.910.5055.0	50
- B DIN 41674 for G-fuses DIN 41576	WK 10/Si U 5 x 25	57.910.5155.0	50
- A DIN 41674 for G-fuses	WK 10/Si U 5 x 30	57.910.5255.0	50
- with screw cap for G-fuses	WK 10/Si U 6,3 x 32	57.910.5355.0	50

GENERAL DATA

Width / length / height, incl. TS 7.5	12 mm / 65 mm / 58 mm
Wire strip length	13 mm
Approvals	

TECHNICAL DATA

	IEC	UL	CSA
	EN 60947-7-1, EN 60127-6		
Cross section fine-stranded	1.0 – 10 mm ²		
Cross section solid/stranded	1.0 – 16 mm ²		
Cross section, AWG		22 – 6	16 – 6
Rated current	max. 10 A ¹⁾	15 A	max. 15 A
Rated voltage	500 V*	600 V*	600 V*
	* 57.910.5055.0 250 V~	600 V	600 V
	* 57.910.5155.0 250 V~	600 V	600 V
	* 57.910.5255.0 500 V~	600 V	600 V
	* 57.910.5355.0 500 V~	600 V	600 V
Rated impulse voltage	6 kV		
Pollution degree	3		

WK 10/SI .../U WITH INDICATOR

- Fuse block with screw cap for mounting on TS 35 and TS 32
- Nominal cross section 10 mm²
- With indicator

* Voltage and current are determined by the built-in indicator and the inserted G-fuse.



Description	Type	Part No.	Std. Pack
Fuse block, with screw cap	gray		
- A DIN 41674 for G-fuses DIN 41571	WK 10/Si U 5 x 20M, NGL	57.910.5455.0	50
- B DIN 41674 for G-fuses DIN 41576	WK 10/Si U 5 x 20M, GLB	57.910.5855.0	50
- A DIN 41674 for G-fuses	WK 10/Si U 6,3 x 32M, NGL	57.910.5755.0	50
- with screw cap for G-fuses	WK 10/Si U 6,3 x 32M, GLB	57.910.6155.0	50

GENERAL DATA

Width / length / height, incl. TS 7.5	12 mm / 65 mm / 58 mm
Wire strip length	13 mm
Approvals	

TECHNICAL DATA

	IEC	UL	CSA
	EN 60947-7-1, EN 60127-6		
Cross section fine-stranded	1.0 – 10 mm ²		
Cross section solid/stranded	1.0 – 16 mm ²		
Cross section, AWG		22 – 6	16 – 6
Rated current	max. 10 A ¹⁾	15 A	max. 15 A
Rated voltage	500 V*	600 V*	600 V*
Indicator – Current consumed			
red – 0.16 - 0.8 mA	* 57.910.5455.0 110 - 250V~	150 V	500 V
yellow – 24 mA	* 57.910.5855.0 28V~	28 V	28 V
red – 0.16 - 0.8 mA	* 57.910.5755.0 110 - 500V~	150 V	500 V
yellow – 24 mA	* 57.910.6155.0 28V~	28 V	28 V
Rated impulse voltage	6 kV		
Pollution degree	3		

ACCESSORIES AND INFO FOR SELOS WK 10/SI



ACCESSORIES	Type	Part No.	Std. Pack
End plate	gray AP 10/Si	07.311.4155.0	10
Cross connector with screws	2-pole	VB WK 10/Si-2	10
	3-pole	VB WK 10/Si-3	10
	up to 6-pole	VB WK 10/Si-6	10
			Z7.287.0627.0
Transparent block cover (for 1 block)		04.312.2056.0	100

¹⁾ Maximum power loss at 23°C ambient temperature (according to DIN EN 60947-7-3)

Type	Overload protection		Exclusive short-circuit protection	
	Single arrangement	Group arrangement	Single arrangement	Group arrangement
WK 10 Si U 5x20	4.0W/10A	2.5W/6.3A	4.0W/10A	4.0W/6.3A
WK 10 Si U 6.3x32	4.0W/10A	2.5W/2.5A	4.0W/10A	2.5W/2.5A
WK 10 Si U 5x25	4.0W/10A	2.5W/6.3A	4.0W/10A	4.0W/6.3A
WK 10 Si U 5x30	4.0W/10A	2.5W/6.3A	4.0W/10A	4.0W/6.3A

SELOS · FEED-THROUGH BLOCKS WITH WIECON PLUGGABLE CONNECTION

FOR PC BOARD TERMINAL TYPE 8113 B, TYPE 8313 B, TYPE 8113 B/VL, TYPE 8113 B/VR, TYPE 8113 B/TOP

WK 2,5 U/D/8113 S/V

- Feed-through block with screw connection for mounting on TS 35 and TS 32
- Nominal cross section 2,5 mm²

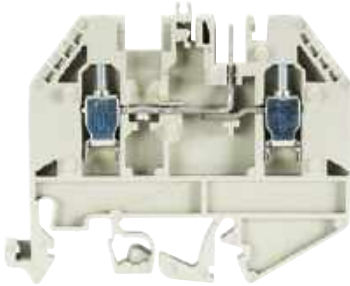

Description	Type	Part No.	Std. Pack
Feed-through block	gray WK 2,5 U/D/8113 S/V...	57.503.2155.0	50
Power block	blue WK 2,5 U/D/8113 S/V/VK	57.503.2555.6	50
Feed-through block, with LED 25V	gray WK 2,5 U/D/8113 S/V/LED 25	57.503.2255.0	50
Feed-through block, with LED 50V	gray WK 2,5 U/D/8113 S/V/LED 50	57.503.2355.0	50

GENERAL DATA

Width / length / height, incl. TS 7.5	5 mm / 61 mm / 51 mm
Wire strip length	9 mm
Approvals	UL, CE, RoHS

TECHNICAL DATA

	IEC	UL	CSA
	EN 60947-7-1		
Cross section fine-stranded	0.5 – 2,5 mm ²		
Cross section solid/stranded	0.5 – 4 mm ²		
Cross section, AWG		22 – 12	24 – 12
Rated current	12 A	15 A	15 A
Rated voltage	250 V	300 V	300 V
Rated impulse voltage	4 kV		
Pollution degree	3		

ACCESSORIES

Description	Type	Part No.	Std. Pack
End plate	gray AP 2,5 U/D/8113 S/V	07.311.9055.0	10
Spacer*	2.5 mm thick ZP 2,5 U/D/8113 S/V	07.311.9155.0	10
Cover strip for LED, transparent	10-pole AD VB 5/10 P	04.342.3556.8	10
Coding strip		05.561.0053.0	100

* for wiecon PC board connector with 7.5 mm pitch

WK 2,5 U/8113 S/V

- Feed-through block with screw connection for mounting on TS 35 and TS 32
- Nominal cross section 2,5 mm²



Description	Type	Part No.	Std. Pack
Feed-through block	gray WK 2,5 U/8113 S/V...	57.503.2655.0	50
Power block	blue WK 2,5 U/8113 S/V/VK	57.503.3055.6	50
Feed-through block, with LED 25V	gray WK 2,5 U/8113 S/V/LED 25	57.503.2755.0	50
Feed-through block, with LED 50V	gray WK 2,5 U/8113 S/V/LED 50	57.503.2855.0	50

GENERAL DATA

Width / length / height, incl. TS 7.5	5 mm / 44 mm / 51 mm
Wire strip length	9 mm
Approvals	UL, CE, RoHS

TECHNICAL DATA

	IEC	UL	CSA
	EN 60947-7-1		
Cross section fine-stranded	0.5 – 2,5 mm ²		
Cross section solid/stranded	0.5 – 4 mm ²		
Cross section, AWG		22 – 12	24 – 12
Rated current	12 A	15 A	15 A
Rated voltage	250 V	300 V	300 V
Rated impulse voltage	4 kV		
Pollution degree	3		

ACCESSORIES

Description	Type	Part No.	Std. Pack
End plate	gray AP 2,5 U/8113 S/V	07.312.1555.0	10
Spacer*	2.5 mm thick ZP 2,5 U/8113 S/V	07.312.1655.0	10
Coding strip		05.561.0053.0	100

* for wiecon PC board connector with 7.5 mm pitch

WK 2,5 U/D/8113 S/H

- Feed-through block with screw connection for mounting on TS 35 and TS 32
- Nominal cross section 2,5 mm²



Description	Type	Part No.	Std. Pack
Feed-through block	gray WK 2,5 U/8113 S/H	57.503.2055.0	100

GENERAL DATA

Width / length / height, incl. TS 7.5	5 mm / 44 mm / 48 mm
Wire strip length	9 mm
Approvals	UL, CE, RoHS

TECHNICAL DATA

	IEC	UL	CSA
	EN 60947-7-1		
Cross section fine-stranded	0.5 – 2,5 mm ²		
Cross section solid/stranded	0.5 – 4 mm ²		
Cross section, AWG		22 – 12	24 – 12
Rated current	12 A	20 A	15 A
Rated voltage	250 V	300 V	300 V
Rated impulse voltage	4 kV		
Pollution degree	3		

ACCESSORIES

Description	Type	Part No.	Std. Pack
End plate	gray AP 2,5 U/8113 S/H	07.311.9855.0	10
Coding strip		05.584.0053.0	100
Locking piece	10-pole	05.576.5853.0	25

More accessories page 130 ff.

TYPE 8113 B/..., 8313 B/...

- Mating orientation parallel to wire entry
- For additional pluggable blocks, see wiecon product family



Description	Type	Part No.	Std. Pack
Spacing 5.00 mm, Rated voltage 250 V			
unmarked, starting at 2	8113 B/2 OB	25.320.3253.0	100
up to 16	8113 B/16 OB	25.320.4653.0	50
marked with 1- x, starting at 2	8113 B/2	25.320.0253.0	100
up to 16	8113 B/16	25.320.1653.0	50
Spacing 7.50 mm, Rated voltage 400 V			
unmarked, starting at 2	8313 B/2 OB	25.360.3253.0	100
up to 12	8313 B/12 OB	25.360.4253.0	50
marked with 1- x, starting at 2	8313 B/2	25.360.0253.0	100
up to 12	8313 B/12	25.360.1253.0	50
GENERAL DATA			
Approvals			
TECHNICAL DATA		IEC	UL CSA
		EN 60 947-7-1	
Cross section fine-stranded	0.5 – 2.5 mm ²		
Cross section solid/stranded	0.5 – 4 mm ²		
Cross section, AWG		22 – 12	24 – 12
Rated current	12 A	15 A	15 A
Rated voltage	250 V	300 V	300 V
Rated impulse voltage	400 V		
Pollution degree			
ACCESSORIES		Type	Part No. Std. Pack
	Coding strip		05.561.9153.0 100

TYPE 8113 B/... VR

- Mating orientation 90° towards the wire
- For additional pluggable blocks, see wiecon product family



Description	Type	Part No.	Std. Pack
Spacing 5.00 mm, Rated voltage 250 V			
unmarked, starting at 2	8113 B/2 VR OB	25.325.3253.0	100
up to 16	8113 B/16 VR OB	25.325.4653.0	50
marked with 1- x, starting at 2	8113 B/2	25.325.0253.0	100
up to 16	8113 B/16	25.325.1653.0	50
GENERAL DATA			
Approvals			
TECHNICAL DATA		IEC	UL CSA
		EN 60 947-7-1	
Cross section fine-stranded	0.5 – 2.5 mm ²		
Cross section solid/stranded	0.5 – 4 mm ²		
Cross section, AWG		22 – 12	24 – 12
Rated current	12 A	15 A	15 A
Rated voltage	250 V	300 V	300 V
Rated impulse voltage	400 V		
Pollution degree			
ACCESSORIES		Type	Part No. Std. Pack
	Coding strip		05.561.9153.0 100

ACCESSORIES FOR SELOS WK 2,5 U

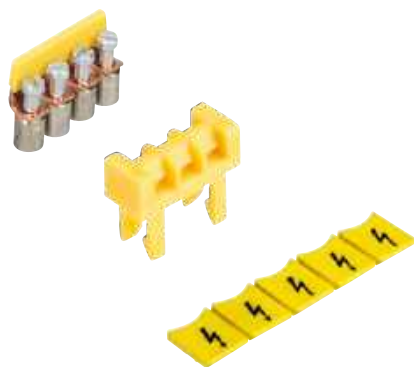

ACCESSORIES	Type	Part No.	Std. Pack
Cross connector with screws, insulated	2-pole	VB WK 2,5-2	Z7.280.2227.0 10
	3-pole	IVB WK 2,5-3	Z7.280.2327.0 10
	12-pole	IVB WK 2,5-12	Z7.280.3227.0 10
Partition plate with marking facility	yellow	TS 2,5 GELB	07.311.2053.8 10
Single cover with marking facility	yellow	AD VB 2,5 GELB	04.326.2053.8 10
Cover strip for PCB terminal	24-pole		04.343.9056.8 10
with warning symbol	24-pole		04.343.9156.8 10
Connection rail	L = 0,4 m		05.561.4125.0 1
for connection to power block (blue) and indicator			

SELOS · DISTRIBUTION BLOCKS WITH SCREW / PUSH-ON CONNECTION

WK/4-8 S/IW/U

- Feed-through block with push-on connection for mounting on TS 35
- Push-on connectors 2.8 x 0.8 acc. to DIN 46247
Push-on connectors 6.3 x 0.8 acc. to DIN 46247
- Current carrying capability according to DIN 46249
Tab connector 2.8 10A
 6.3 20A



Description	Type	Part No.	Std. Pack
Feed-through block	gray WK/4-8 S/IW/U	57.504.6355.0	100
GENERAL DATA			
Width / length / height, incl. TS 7.5	6 mm / 67 mm / 50 mm		
Wire strip length			
Approvals			
TECHNICAL DATA		IEC	UL CSA
		EN 60947-7-1, EN 61210	
Cross section fine-stranded			
Cross section solid/stranded			
Cross section, AWG		22 – 12	22 – 12
Rated current	20 A	10 A	10 A
Rated voltage	800 V ⁽¹⁾	600 V ⁽¹⁾	300 V ⁽¹⁾
Rated impulse voltage	8 kV		
Pollution degree	3		
ACCESSORIES			
End plate	gray AP 3 S/IW	07.311.4355.0	50
Cross connector with screws	2-pole	VB WK/...S/IW/U-2	10
	3-pole	VB WK/...S/IW/U-3	10
	up to 6-pole	VB WK/...S/IW/U-6	10

WK/4-8 S/U

- Feed-through block with push-on connection for mounting on TS 35
- Push-on connectors 2.8 x 0.8 acc. to DIN 46247
Push-on connectors 6.3 x 0.8 acc. to DIN 46247
- Current carrying capability according to DIN 46249
Tab connector 2.8 10A
 6.3 20A



Description	Type	Part No.	Std. Pack
Feed-through block	gray WK/4-8 S/U	57.504.6255.0	100
GENERAL DATA			
Width / length / height, incl. TS 7.5	6 mm / 67 mm / 40 mm		
Wire strip length			
Approvals			
TECHNICAL DATA		IEC	UL CSA
		EN 60947-7-1, EN 61210	
Cross section fine-stranded			
Cross section solid/stranded			
Cross section, AWG		22 – 12	22 – 12
Rated current	20 A	10 A	10 A
Rated voltage	800 V ⁽¹⁾	300 V ⁽¹⁾	300 V ⁽¹⁾
Rated impulse voltage	8 kV		
Pollution degree	3		
ACCESSORIES			
End plate	gray AP 4 S	07.311.4255.0	10
Cross connector with screws	2-pole	9703/6-2	50
	3-pole	9703/6-3	50
	up to 6-pole	9703/6-6	50

WK/3-6 S KO/U

- Feed-through block with push-on connection for mounting on TS 35
- Nominal cross section 4,0 mm²
- Push-on connectors 2.8 x 0.8 acc. to DIN 46247
Push-on connectors 6.3 x 0.8 acc. to DIN 46247
- Current carrying capability according to DIN 46249
Tab connector 2.8 10A
 6.3 20A

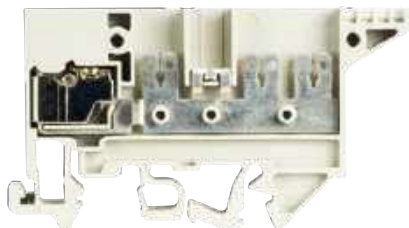

Description	Type	Part No.	Std. Pack
Feed-through block	gray WK/3-6 S KO/U	57.504.7355.0	100
GENERAL DATA			
Width / length / height, incl. TS 7.5	6 mm / 72 mm / 40 mm		
Wire strip length	9 mm		
Approvals			
TECHNICAL DATA		IEC	UL CSA
		EN 60947-7-1, EN 61210	
For use with insulating sleeves			
Cross section fine-stranded	0.5 – 4 mm ²		
Cross section solid/stranded	0.5 – 4 mm ²		
Cross section, AWG		22 – 12	22 – 12
Rated current	20 A	10 A	10 A
Rated voltage	690 V ⁽¹⁾	300 V ⁽¹⁾	300 V ⁽¹⁾
Rated impulse voltage	8 kV		
Pollution degree	3		
ACCESSORIES			
End plate	gray 9701 A/6 1 S KO TP 2	07.310.5855.0	10
Cross connector with screws	2-pole	2072/2	50
	3-pole	2072/2	50
	up to 6-pole	2072/6	50

More accessories page 130 ff.

WK 4 3-6 S 1 K/U

- Feed-through block with push-on connection for mounting on TS 35
- Nominal cross section 4 mm²
- Push-on connectors 2.8 x 0.8 acc. to DIN 46247
- Push-on connectors 6.3 x 0.8 acc. to DIN 46247
- Current carrying capability according to DIN 46249

Tab connector	2.8	10A
	6.3	20A



Description	Type	Part No.	Std. Pack
Feed-through block	gray WK 4 3-6 S 1 K/U	57.504.3755.0	100

GENERAL DATA

Width / length / height, incl. TS 7.5	6 mm / 52 mm / 48 mm
Wire strip length	9 mm
Approvals	

TECHNICAL DATA

	IEC	UL	CSA
	EN 60947-7-1, EN 61210		
Cross section fine-stranded	0.5 – 4 mm ²		
Cross section solid/stranded	0.5 – 6 mm ²		
Cross section, AWG		22 – 12	22 – 12
Rated current	20 A	10 A	10 A
Rated voltage	800 V ¹⁾	300 V ¹⁾	300 V ¹⁾
Rated impulse voltage	8 kV		
Pollution degree	3		

ACCESSORIES

Description	Type	Part No.	Std. Pack
End plate	gray AP4 3 S 1 K	07.311.3855.0	10
Cross connector with screws	2-pole IVB WK 4-2	Z7.281.1227.0	10
	3-pole IVB WK 4-3	Z7.281.1327.0	10
	up to 12-pole IVB WK 4-12	Z7.281.2227.0	10

WK/5-10 S/U

- Feed-through block with push-on connection for mounting on TS 35
- Push-on connectors 2.8 x 0.8 acc. to DIN 46247
- Push-on connectors 6.3 x 0.8 acc. to DIN 46247
- Current carrying capability according to DIN 46249

Tab connector	2.8	10A
	6.3	20A



Description	Type	Part No.	Std. Pack
Feed-through block	gray WK/5-10 S/U	57.504.3655.0	100

GENERAL DATA

Width / length / height, incl. TS 7.5	6 mm / 52 mm / 48 mm
Wire strip length	
Approvals	

TECHNICAL DATA

	IEC	UL	CSA
	EN 60947-7-1, EN 61210		
Cross section fine-stranded			
Cross section solid/stranded			
Cross section, AWG		22 – 12	
Rated current	20 A	10 A	10 A
Rated voltage	800 V ¹⁾	300 V ¹⁾	300 V ¹⁾
Rated impulse voltage	8 kV		
Pollution degree	3		

ACCESSORIES

Description	Type	Part No.	Std. Pack
End plate	gray AP 5 S	07.311.4655.0	10
Cross connector with screws	2-pole IVB WKI 4-2	Z7.271.4227.0	10
	3-pole IVB WKI 4-3	Z7.271.4327.0	10
	up to 12-pole IVB WKI 4-12	Z7.271.5227.0	10

ACCESSORIES FOR SELOS WK



ACCESSORIES

Description	Type	Part No.	Std. Pack
Partition plate with marking facility	yellow TS 4 GELB	07.311.2153.8	10
Single cover with marking facility	yellow AD VB 4 GELB	04.326.2153.8	10
Insulating sleeve for tab connector			

¹⁾ Rating for use with insulating sleeves

MEASURING DISCONNECT BLOCKS WITH SCREW CONNECTION

Wieland Electric's selos WKN 6 TK block offers a simple and effective DIN rail block solution for use in measuring circuits for current, voltage or energy. All circuits in everyday practice can be neatly implemented with the measuring disconnect block and a few accessory parts. Only two blocks are needed for simple transformer circuits.

The main focus during the development of this block was clear and simple handling as well as universal application. All switching states of the block and the converter circuit are clearly recognizable and the extensive accessory program is easy to use. The block and the accessories meet the requirements of protection against accidental finger touch as per BGV A2.

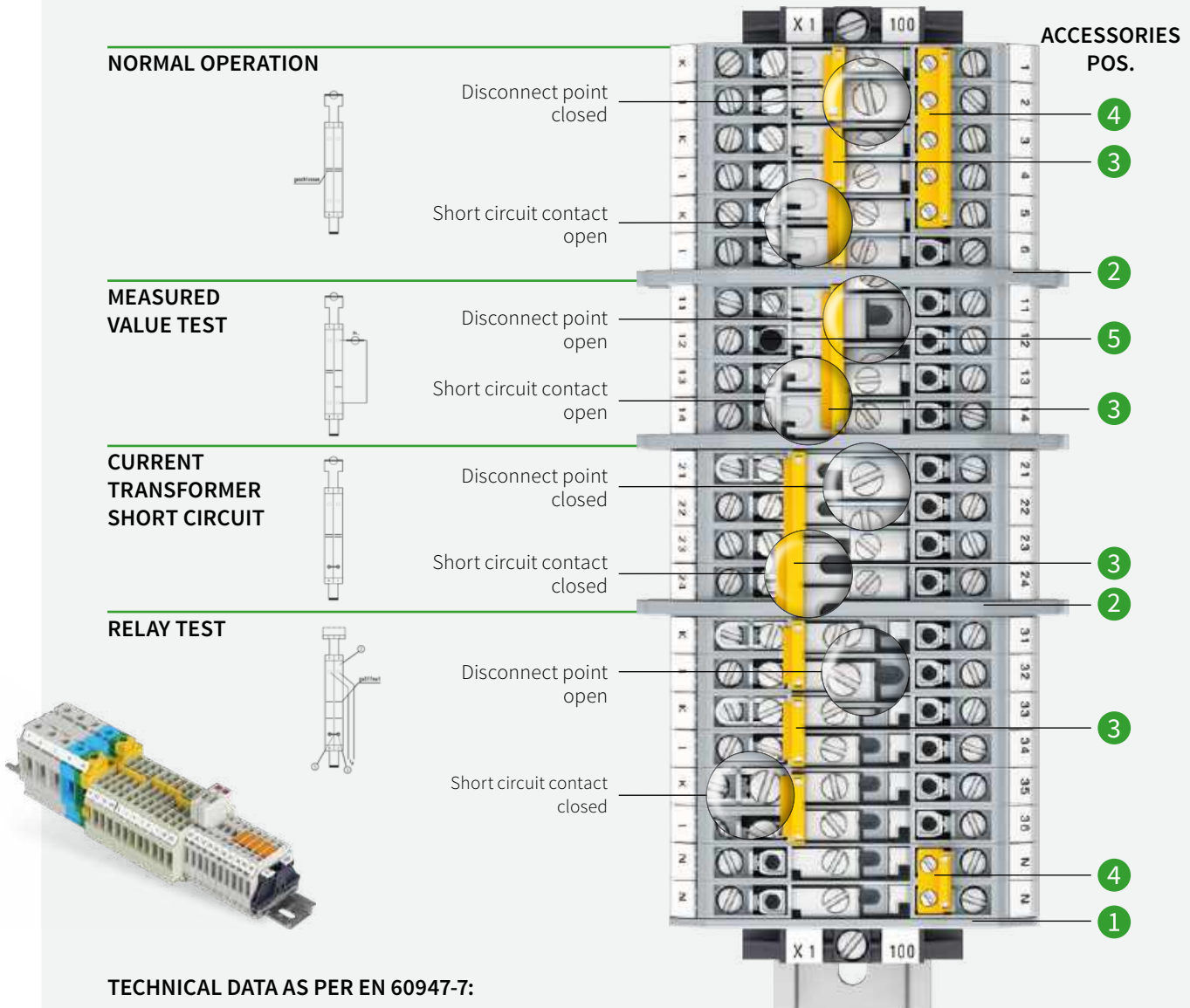

- Rated cross section: 6 mm²
- Rated current: 57 A

- Rated voltage: 400 V
- Connection capacity: 0.5 - 10 mm²

SELOS · MEASURING DISCONNECT BLOCKS WITH SCREW CONNECTION

WKN 6 TK

- Measuring disconnect block for mounting on TS 35
- Nominal cross section 6 mm²



Description	Type	Part No.	Std. Pack
Measuring disconnect block	WKN6 TK	56.106.0055.0	50
Feed-through block	WKN6 TK D	56.106.0155.0	50
GENERAL DATA			
Width / length / height, incl. TS 7.5	8 mm / 73 mm / 58 mm		
Wire strip length	12 mm		
Approvals			
TECHNICAL DATA		IEC	UL
		EN 60947-7-1	
Cross section fine-stranded	0.5 – 6 mm ²		
Cross section solid/stranded	0.5 – 10 mm ²		
Cross section, AWG			
Rated current	57 A		
Rated voltage	500 V		
Rated impulse voltage	6 kV		
Pollution degree	3		

WKN 6 TK SF

- Measuring disconnect block with spring support for mounting on TS 35
- Nominal cross section 6 mm²



Description	Type	Part No.	Std. Pack
Measuring disconnect block	WKN6 TK SF	56.106.0755.0	50
Feed-through block	WKN6 TK SFD	56.106.0855.0	50
GENERAL DATA			
Width / length / height, incl. TS 7.5	8 mm / 73 mm / 58 mm		
Wire strip length	12 mm		
Approvals			
TECHNICAL DATA		IEC	EA TS 50-18
		EN 60947-7-1	
Cross section fine-stranded	0.5 – 6 mm ²		
Cross section solid/stranded	0.5 – 10 mm ²		
Cross section, AWG			
Rated current	57 A		25 A
Rated voltage	500 V		500 V
Rated impulse voltage	6 kV		
Pollution degree	3		

ACCESSORIES FOR SELOS WKN 6 TK

ACCESSORIES	Type	Part No.	Std. Pack
① End plate	2 mm APN 6 TK	07.313.1755.0	10
② Partition	TW 6 TK	07.312.0453.0	10
③ Sliding short-circuit slide, insulated	2-pole IVS WKN6 TK-2	Z7.282.7229.0	10
	3-pole IVS WKN6 TK-3	Z7.282.7329.0	10
	4-pole IVS WKN6 TK-4	Z7.282.7429.0	10
	5-pole IVS WKN6 TK-5	Z7.282.7529.0	10
④ Cross connector with screws, insulated	2-pole IVB WKN6 TK-2	Z7.282.6229.0	10
	3-pole IVB WKN6 TK-3	Z7.282.6329.0	10
	4-pole IVB WKN6 TK-4	Z7.282.6429.0	10
	5-pole IVB WKN6 TK-5	Z7.282.6529.0	10
	6-pole IVB WKN6 TK-6	Z7.282.6629.0	10
	⑤ Test socket	gray SBN 4 GRAU	Z5.511.3553.0
violet SBN 4 VIOLETT		Z5.511.3553.9	10
green SBN 4 GRÜN		Z5.511.3553.7	10
yellow SBN 4 GELB		Z5.511.3553.8	10
blue SBN 4 BLAU		Z5.511.3553.6	10
⑥ Disconnect locking device	SP WKN 6 TK	05.566.6855.9	50
	Jumper comb for WKN 6 TK		
	2-pole IVK WKN 6TK-2	Z7.255.8227.0	10
	3-pole IVK WKN 6TK-3	Z7.255.8327.0	10
	4-pole IVK WKN 6TK-4	Z7.255.8427.0	10
	5-pole IVK WKN 6TK-5	Z7.255.8527.0	10
6-pole IVK WKN 6TK-6	Z7.255.8627.0	10	

More accessories page 144 ff.

Technical information see FACTS & DATA page 158 ff.

Subject to technical modifications

MEASURING DISCONNECT BLOCKS WITH SCREW CONNECTION WK6 TK

Wieland Electric's selos WK 6 TK block offers an optimal DIN rail block solution for all types of measuring circuits of current, voltage or energy. All circuits occurring during everyday practice can be implemented with the measuring disconnect block and a few accessories.

Complete insulated selectable connecting links are available as standard, as are insulated test sockets in all conventional signal colors. Two additional jumpering facilities permit the installation of fixed cross connections (e.g., for internal distribution of the k point of converter circuits). Standard cross connectors in a wide variety of numbers of pins are available for this purpose. The jumpers are easy to disconnect so that you can skip over blocks.

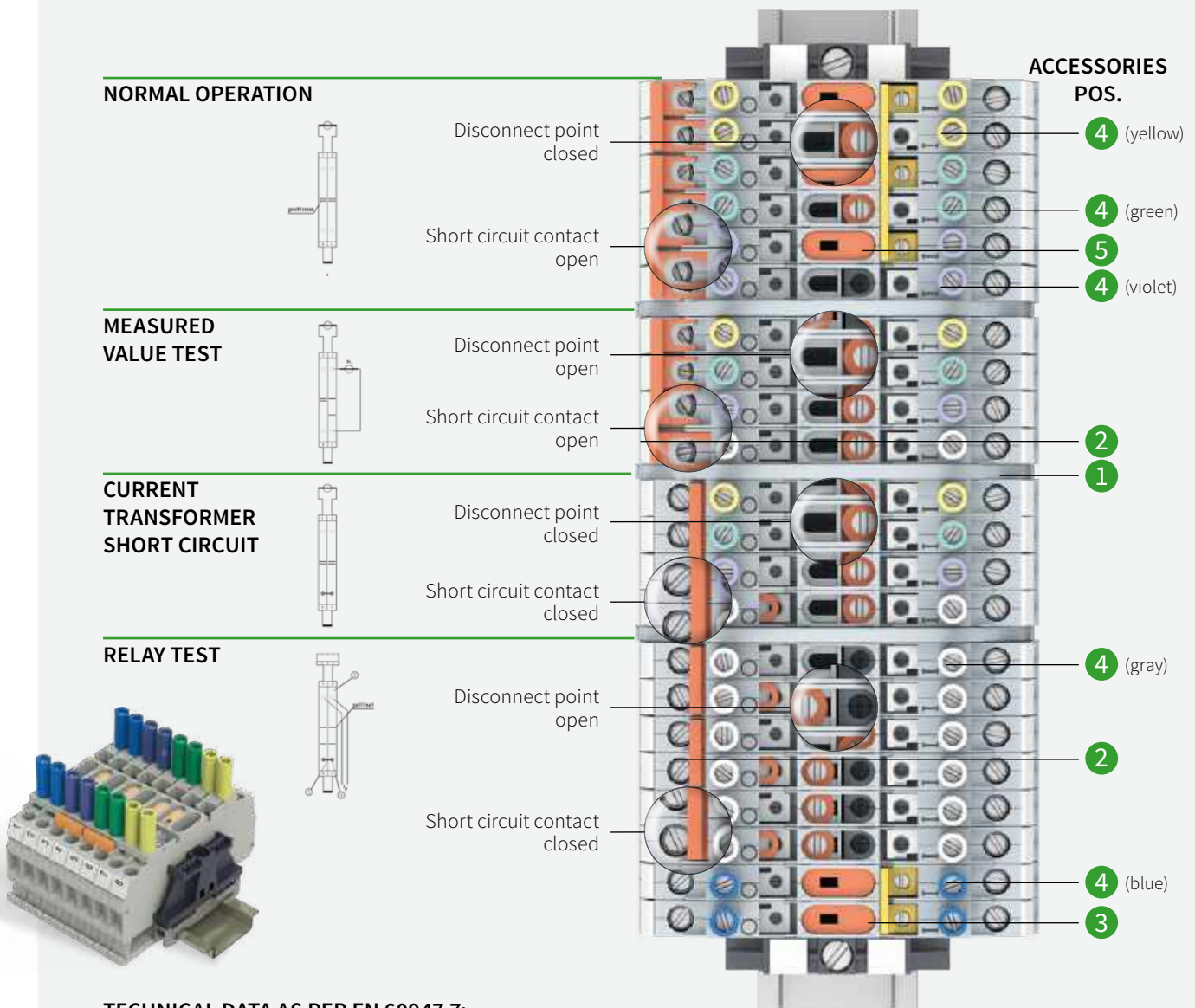

TECHNICAL DATA AS PER EN 60947-7:

- Rated cross section: 6 mm²
- Rated current: 32 A
- Rated voltage: 400 V
- Connection capacity: 0.5 - 10 mm²

SELOS · MEASURING DISCONNECT BLOCKS WITH SCREW CONNECTION WK6 TK

WK6 TK/35

- Measuring disconnect block for mounting on TS 35
- Nominal cross section 6 mm²



Description	Type	Part No.	Std. Pack
Measuring disconnect block	WK6 TK/35	56.106.0553.0	50
GENERAL DATA			
Width / length / height, incl. TS 7.5	8 mm / 87 mm / 49 mm		
Wire strip length	12 mm		
Approvals			
TECHNICAL DATA			
	IEC	UL	CSA
For use with insulating sleeves	EN 60947-7-1		
Cross section fine-stranded	0.5 – 6 mm ²		
Cross section solid/stranded	0.5 – 10 mm ²		
Cross section, AWG		20 – 8	20 – 8
Rated current	32 A	45 A	45 A
Rated voltage	400 V	600 V	300 V
Rated impulse voltage	6 kV		
Pollution degree	3		

WK6 TK P3/35

- Measuring disconnect block with mounted test sockets for mounting on TS 35
- Nominal cross section 6 mm²



Description	Type	Part No.	Std. Pack
Measuring disconnect block	WK6 TK P3/35	56.106.0653.0	50
GENERAL DATA			
Width / length / height, incl. TS 7.5	8 mm / 87 mm / 62 mm		
Wire strip length	12 mm		
Approvals			
TECHNICAL DATA			
	IEC	UL	CSA
For use with insulating sleeves	EN 60947-7-1		
Cross section fine-stranded	0.5 – 6 mm ²		
Cross section solid/stranded	0.5 – 10 mm ²		
Cross section, AWG		20 – 8	20 – 8
Rated current	32 A	45 A	45 A
Rated voltage	400 V	600 V	300 V
Rated impulse voltage	6 kV		
Pollution degree	3		

ACCESSORIES FOR SELOS WK6 TK.../35

ACCESSORIES	Type	Part No.	Std. Pack
1 Partition	TW 6 TK	07.312.0453.0	10
2 Sliding short-circuit slide, insulated	2-pole	IVS WK6 TK-2	27.212.2227.0
	3-pole	IVS WK6 TK-3	27.212.2327.0
	4-pole	IVS WK6 TK-4	27.212.2427.0
3 Cross connector with screws, insulated	2-pole	IVB WK6 TK-2	27.212.1227.0
	3-pole	IVB WK6 TK-3	27.212.1327.0
	4-pole	IVB WK6 TK-4	27.212.1427.0
	5-pole	IVB WK6 TK-5	27.212.1527.0
	10-pole	IVB WK6 TK-10	27.212.2027.0
4 Test socket	gray	SB 4 GRAU	05.511.2953.0
	violet	SB 4 VIOLETT	05.511.2953.9
	green	SB 4 GRÜN	05.511.2953.7
	yellow	SB 4 GELB	05.511.2953.8
5 Disconnect locking device	blue	SB 4 BLAU	05.511.2953.6
		SP WK6 TK	05.563.5453.0

More accessories page 144 ff.

Technical information see FACTS & DATA page 158 ff.

Subject to technical modifications

SELOS · SCREW TYPE TERMINAL BLOCKS WITH SPRING SUPPORT

WKN 6 SF

- Feed-through block with spring support for mounting on TS 35 and TS 32
- Nominal cross section 6 mm²



Description	Type	Part No.	Std. Pack
Feed-through block	gray WKN 6 SF	57.506.0555.0	100
GENERAL DATA			
Width / length / height, incl. TS 7.5	8 mm / 54 mm / 57 mm		
Wire strip length	11 mm		
Approvals			
TECHNICAL DATA		IEC	EA TS 50-18
		EN 60947-7-1	
Cross section fine-stranded	0.5 – 6 mm ²		
Cross section solid/stranded	0.5 – 10 mm ²		
Cross section, AWG			
Rated current	41 A	30 A	
Rated voltage	800 V	500 V	
Rated impulse voltage	8 kV		
Pollution degree	3		
ACCESSORIES			
End plate	gray APN 6 SF	07.313.2355.0	10
Partition	gray TW 6 TK	07.312.0453.0	10
Cross connector with screws	2-pole IVB WK 6 - 2	Z7.282.2227.0	10
insulated	3-pole IVB WK 6 - 3	Z7.282.2327.0	10
	up to 12-pole IVB WK 6 - 12	Z7.282.3227.0	10
Single cover f. cross conn. with marking facility	AD VB 6 GELB	04.326.2253.8	10
Cover with warning symbol	yellow AD VB 8/4 GELB	04.343.4956.8	10

WKN 10 SF

- Feed-through block with spring support for mounting on TS 35 and TS 32
- Nominal cross section 10 mm²



Description	Type	Part No.	Std. Pack
Feed-through block	gray WKN 10 SF	57.510.0555.0	100
GENERAL DATA			
Width / length / height, incl. TS 7.5	10 mm / 55 mm / 64 mm		
Wire strip length	13 mm		
Approvals			
TECHNICAL DATA		IEC	EA TS 50-18
		EN 60947-7-1	
Cross section fine-stranded	2.5 – 10 mm ²		
Cross section solid/stranded	1.5 – 16 mm ²		
Cross section, AWG			
Rated current	57 A	30 A	
Rated voltage	800 V	500 V	
Rated impulse voltage	8 kV		
Pollution degree	3		
ACCESSORIES			
End plate	gray APN 10 SF	07.313.2455.0	10
Partition	gray TW 6 TK	07.312.0453.0	10
Cross connector with screws	2-pole IVB WK 10 - 2	Z7.283.2227.0	10
insulated	3-pole IVB WK 10 - 3	Z7.283.2327.0	10
	up to 12-pole IVB WK 10 - 12	Z7.283.3227.0	10
Single cover f. cross conn. with marking facility	AD VB 10 GELB	04.326.2353.8	10
Cover with warning symbol	yellow AD VB 10/4 GELB	04.343.5056.8	10

SELOS · DIN RAIL TERMINAL BLOCKS WITH RING LUG CONNECTION

WRT 6

- Feed-through block with ring lug connection for mounting on TS 35
- Nominal cross section 6 mm²



Description	Type	Part No.	Std. Pack
Feed-through block	gray WRT 6	57.106.1155.0	100
GENERAL DATA			
Width / length / height, incl. TS 7.5	11 mm / 49 mm / 51 mm		
Wire strip length	10 mm		
Approvals			
TECHNICAL DATA		IEC	UL CSA
		EN 60947-7-1	
Cross section fine-stranded	1.5 – 6 mm ²		
Cross section solid/stranded	1.5 – 6 mm ²		
Cross section, AWG		22 – 8	22 – 8
Rated current	41 A	50 A	50 A
Rated voltage	1000 V	600 V	600 V
Rated impulse voltage	8 kV		
Pollution degree	3		
ACCESSORIES		Type	Part No. Std. Pack
End plate	gray	APRT 6	07.300.6955.0 10
Partition	gray	TW 6 TK	07.312.0453.0 10
Cross connector, insulated	2-pole	IVB WRT 6 TK - 2	Z7.250.5227.0 10
	3-pole	IVB WRT 6 TK - 3	Z7.250.5327.0 10
	4-pole	IVB WRT 6 TK - 4	Z7.250.5427.0 10

WRT 6 TK

- Measuring disconnect block with ring lug connection for mounting on TS 35
- Nominal cross section 6 mm²



Description	Type	Part No.	Std. Pack
Measuring disconnect block	gray WRT 6 TK	57.106.1055.0	100
GENERAL DATA			
Width / length / height, incl. TS 7.5	11 mm / 86 mm / 51 mm		
Wire strip length	10 mm		
Approvals			
TECHNICAL DATA		IEC	UL CSA
		EN 60947-7-1	
Cross section fine-stranded	1.5 – 6 mm ²		
Cross section solid/stranded	1.5 – 6 mm ²		
Cross section, AWG		22 – 8	22 – 8
Rated current	41 A	35 A	35 A
Rated voltage	1000 V	600 V	600 V
Rated impulse voltage	8 kV		
Pollution degree	3		
ACCESSORIES		Type	Part No. Std. Pack
End plate	gray	APRT 6 TK	07.300.7055.0 10
Partition	gray	TW 6 TK	07.312.0453.0 10
Cross connector, insulated	2-pole	IVB WRT 6 TK - 2	Z7.250.5227.0 10
	3-pole	IVB WRT 6 TK - 3	Z7.250.5327.0 10
	4-pole	IVB WRT 6 TK - 4	Z7.250.5427.0 10

SELOS WRT – THE NEW GENERATION OF HIGH CURRENT TERMINALS

The selosWRT high current terminals are the new generation of ring lug terminals for safe and maintenance-free energy transmission.

A broad range and a clear focus on customer benefits makes selos WRT a robust solution for connecting conductors to 300 mm² and 520 A.



SIMPLE AND FAST MOUNTING

- On TS 35 or on the mounting plate
- Few parts – nut with integrated spring washer

TOUCH-PROOF APPLICATION

- Cover easy to open and close
- Test opening – completely touch-proof voltage measurement
- Cover can be individually adapted

FLEXIBLE POTENTIAL DISTRIBUTION

- Cross connectors for simple potential distribution up to nominal currents
- Multi-conductor connection possible, 2 cable lugs per connection point

- + Rugged design
- + Vibration-proof + Maintenance-free
- + Flexible potential distribution
- + Reliable touch protection

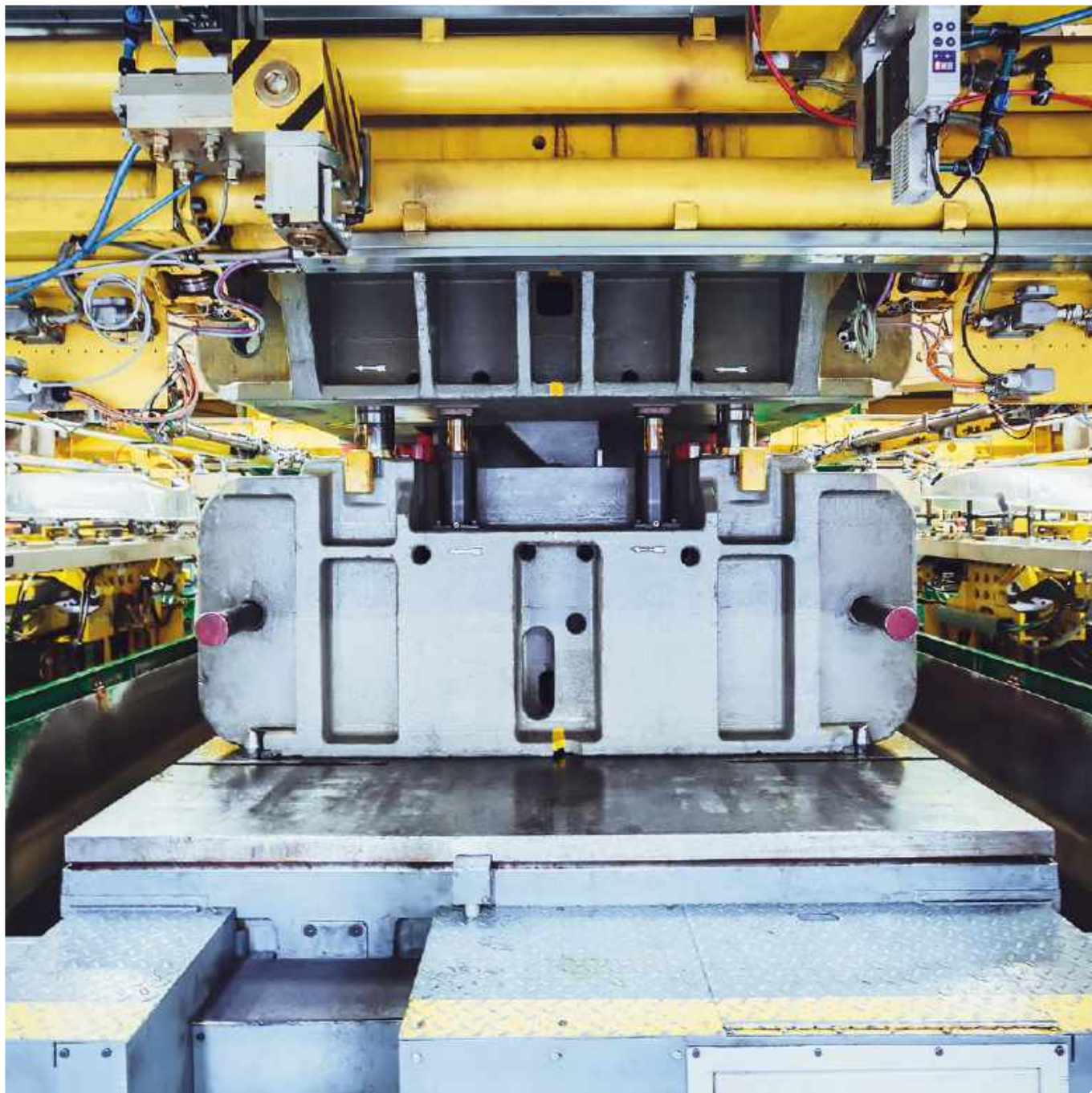

PERFORMANCE FEATURES

- + Connection cross-section: up to 300 mm²
- + Rated current: up to 520 A IEC / 510 A UL, CSA
- + Rated voltage: up to 1000 V

SELOS WRT · HIGH CURRENT TERMINALS WITH SCREW CONNECTION

WRT 35

- High current terminal block for mounting on TS 35
- Nominal cross-section 35 mm²
- Bolt connection M6



Description	Type	Part No.	Std. Pack	
High current terminal block	WRT 35 / M6	56.135.1055.0	10	
GENERAL DATA				
Width / length / height (incl. TS 7.5)	27 mm / 107 mm / 51 mm			
Width / length / height (incl. TS 7.5 & cover)	27 mm / 131 mm / 60 mm			
Screw size	M6			
Approvals				
Technical data		IEC	UL	CSA
Cross section fine-stranded	2.5 - 50 mm ²			
Cross section solid/stranded	2.5 - 50 mm ²			
Cross-section, AWG	14 - 1 / 0		14 - 1 / 0	
Rated current	125 A	130 A	130 A	
Rated voltage	1000 V	1000 V	1000 V	
Rated impulse voltage	8 kV			
Pollution degree	3			
Torque	3 - 6 Nm			
ACCESSORIES		Type	Part No.	Std. Pack
Cover (2 piece/terminal required)	AD WRT 35	07.431.7053.8	20	
Cross connector, for 2 terminals	VB WRT 35-2	07.201.1227.6	5	
Cross connector, for 3 terminals	VB WRT 35-3	07.201.1327.6	5	

WRT 70

- High current terminal block for mounting on TS 35
- Nominal cross-section 70 mm²
- Bolt connection M8



Description	Typ	Part No.	Std. Pack	
High current terminal block	WRT 70	56.170.1055.0	10	
GENERAL DATA				
Width / length / height (incl. TS 7.5)	32 mm / 132 mm / 61 mm			
Width / length / height (incl. TS 7.5 & cover)	32 mm / 180 mm / 70 mm			
Screw size	M8			
Approvals				
TECHNICAL DATA		IEC	UL	CSA
Cross section fine-stranded	2.5 - 95 mm ²			
Cross section solid/stranded	2.5 - 95 mm ²			
Cross-section, AWG	14 - 3 / 0		14 - 3 / 0	
Rated current	192 A	175 A	175 A	
Rated voltage	1000 V	1000 V	1000 V	
Rated impulse voltage	8 kV			
Pollution degree	3			
Torque	6 - 12 Nm			
ACCESSORIES		Type	Part No.	Std. Pack
Cover (2 piece/terminal required)	AD WRT 70	07.431.7153.8	20	
Cross connector, for 2 terminals	VB WRT 70-2	07.201.3227.6	5	
Cross connector, for 3 terminals	VB WRT 70-3	07.201.3327.6	5	

WRT 120

- High current terminal block for mounting on TS 35
- Nominal cross-section 120 mm²
- Bolt connection M10



Description	Type	Part No.	Std. Pack	
High current terminal block	WRT 120	56.197.1055.0	5	
General data				
Width / length / height (incl. TS 7.5)	42 mm / 133 mm / 72 mm			
Width / length / height (incl. TS 7.5 & cover)	42 mm / 226 mm / 80 mm			
Screw size	M10			
Approvals				
Technical data		IEC	UL	CSA
Cross section fine-stranded	to 120 mm ²			
Cross section solid/stranded	6 - 150 mm ²			
Cross-section, AWG	10 - 250 kcmil		10 - 250 kcmil	
Rated current	269 A	225 / 310 A *)	225 / 310 A *)	
Rated voltage	1000 V	1000 V	1000 V	
Rated impulse voltage	8 kV			
Pollution degree	3			
Torque	10 - 20 Nm			
Accessories		Type	Part No.	Std. Pack
Cover (2 piece/terminal required)	AD WRT 120	07.431.7253.8	10	
Cross connector, for 2 terminals	VB WRT 120-2	07.201.5227.6	5	
Cross connector, for 3 terminals	VB WRT 120-3	07.201.5327.6	5	

*) field / factory wiring

WRT 185

- High current terminal block for mounting on TS 35
- Nominal cross-section 185 mm²
- Bolt connection M12



Description	Type	Part No.	Std. Pack
High current terminal block	WRT 185	56.198.1055.0	5
General data			
Width / length / height (incl. TS 7.5)	55 mm / 164 mm / 78 mm		
Width / length / height (incl. TS 7.5 & cover)	55 mm / 288 mm / 90 mm		
Screw size	M12		
Approvals			
Technical data			
	IEC	UL	CSA
Cross section fine-stranded	to 185 mm ²		
Cross section solid/stranded	10 - 240 mm ²		
Cross-section, AWG		8 - 500 kcmil	8 - 500 kcmil
Rated current	353 A	380 A	380 A
Rated voltage	1000 V	1000 V	1000 V
Rated impulse voltage	8 kV		
Pollution degree	3		
Torque	14 - 31 Nm		
ACCESSORIES			
	Type	Part No.	Std. Pack
Cover (2 piece/terminal required)	AD WRT 185/300	07.431.7353.8	10
Cross connector, for 2 terminals	VB WRT 185-2	07.201.7227.6	5
Cross connector, for 3 terminals	VB WRT 185-3	07.201.7327.6	5

WRT 300

- High current terminal block for mounting on TS 35
- Nominal cross-section 300 mm²
- Bolt connection M16



Description	Type	Part No.	Std. Pack
High current terminal block	WRT 300	56.199.1055.0	5
General data			
Width / length / height (incl. TS 7.5)	55 mm / 164 mm / 78 mm		
Width / length / height (incl. TS 7.5 & cover)	55 mm / 288 mm / 90 mm		
Screw size	M16		
Approvals			
Technical data			
	IEC	UL	CSA
Cross section fine-stranded	to 300 mm ²		
Cross section solid/stranded	25 - 240 mm ²		
Cross-section, AWG		6 - 600 kcmil	6 - 600 kcmil
Rated current	520 A	420/510 A *)	420/510 A *)
Rated voltage	1000 V	1000 V	1000 V
Rated impulse voltage	8 kV		
Pollution degree	3		
Torque	25 - 60 Nm		
Accessories			
	Type	Part No.	Std. Pack
Cover (2 piece/terminal required)	AD WRT 185/300	07.431.7353.8	10
Cross connector, for 2 terminals	VB WRT 300-2	07.201.9227.6	5
Cross connector, for 3 terminals	VB WRT 300-3	07.201.9327.6	5

*) field / factory wiring

BK M .../35

- Ring lug terminal for mounting on TS 35



Description	Type	Part No.	Std. Pack	
Ring lug terminal	BK M 6/35	32.530.0053.0	25	
	BK M 8/35	32.540.0053.0	25	
	BK M 10/35	32.550.0053.0	25	
	BK M 12/35	32.560.0053.0	25	
GENERAL DATA				
Approvals				
TECHNICAL DATA				
	BK M 6	BK M 8	BK M 10	BK M 12
Width / height	19 x 56	24 x 65	35 x 72	35 x 74
Rated current	125 A	150 A	265 A	265 A
Rated voltage	1000 V / 8 kV / 3 with partition TW BK			
ACCESSORIES				
	Type	Part No.	Std. Pack	
Partition	for BK M 6	TW BK M 6/35	07.340.3553.0	25
	for BK M 8	TW BK M 8/35	07.340.3653.0	25
	for BK M 10	TW BK M 10-12/35	07.340.3753.0	25
	for BK M 12	TW BK M 10-12/35	07.340.3753.0	25
Cross connector for tab connection blocks, from E-Cu	for 2 blocks BK M 6	VB BK M 6/35-2	07.205.5227.0	20
	for 3 blocks BK M 6	VB BK M 6/35-3	07.205.5327.0	10
	for 2 blocks BK M 8	VB BK M 8/35-2	07.205.7227.0	20
	for 3 blocks BK M 8	VB BK M 8/35-3	07.205.7327.0	10
	for 2 blocks BK M 10	VB BK M 10/35-2	07.205.8227.0	20
	for 3 blocks BK M 10	VB BK M 10/35-3	07.205.8327.0	10
for 2 blocks BK M 12	VB BK M 12/35-2	07.205.9227.0	20	
for 3 blocks BK M 12	VB BK M 12/35-3	07.205.9327.0	10	

Technical information see FACTS & DATA page 158 ff.

Subject to technical modifications

SELOS WRT · HIGH CURRENT BLOCKS WITH SCREW CONNECTION

RFK 1/95... S35

- High current block for mounting on TS 35
- Nominal cross section 95 mm²



Description	Type	Part No.	Std. Pack	
Feed-through block	gray	F RFK 1/95 F S 35	56.395.0055.0	10
		K RFK 1/95 K S 35	56.395.0155.0	10
		FK RFK 1/95 FK S 35	56.395.0255.0	10
		FM RFK 1/95 FM S 35	56.395.1055.0	10
		FMK RFK 1/95 FMK S 35	56.395.1255.0	10

GENERAL DATA

Width / length / height, incl. TS 7.5	see list p. 53
Wire strip length	27 mm
Approvals	

TECHNICAL DATA

	IEC	UL	CSA
	EN 60947-7-1		
Cross section fine-stranded	16 – 95 mm ²		
Cross section solid/stranded	16 – 95 mm ²		
Cross section, AWG		6 - 3 / 0	6 - 3 / 0
Rated current	250 A	200 A	200 A
Rated voltage	1000 V	600 V	600 V
Rated impulse voltage	8 kV		
Pollution degree	3		

ACCESSORIES

Description	Type	Part No.	Std. Pack	
Cover for RFK 1 / ...	yellow	AD RFK 95	27.409.5753.0	10
Partition / end plate	2.8 mm thick	TE/RFK 1/95	07.340.0353.0	50
Cross connector, from E-Cu	for 2 blocks	VB RFK 1/95/2/32	07.205.1227.0	20
	for 3 blocks	VB RFK 1/95/3/32	07.205.1327.0	10
	for 4 blocks	VB RFK 1/95/4/32	07.205.1427.0	10

RFK 1/150... S35

- High current block for mounting on TS 35
- Nominal cross section 150 mm²



Description	Type	Part No.	Std. Pack	
Feed-through block	gray	F RFK 1/150 F S35	56.397.0055.0	10
		K RFK 1/150 K S35	56.397.0155.0	10
		FK RFK 1/150 FK S35	56.397.0255.0	10
		FM RFK 1/150 FM S35	56.397.1055.0	10
		FMK RFK 1/150 FMK S35	56.397.1255.0	10

GENERAL DATA

Width / length / height, incl. TS 7.5	see list p. 53
Wire strip length	27 mm
Approvals	

TECHNICAL DATA

	IEC	UL	CSA
	EN 60947-7-1		
Cross section fine-stranded	70 – 150 mm ²		
Cross section solid/stranded	70 – 150 mm ²		
Cross section, AWG		0 - 300 kcmil	0 - 300 kcmil
Rated current	335 A	275 A	300 A
Rated voltage	1000 V	600 V	600 V
Rated impulse voltage	8 kV		
Pollution degree	3		

ACCESSORIES

Description	Type	Part No.	Std. Pack	
Cover for RFK 1 / ...	yellow	AD RFK 150 - 240	27.409.5853.0	10
Partition / end plate	2.8 mm thick	TE/RFK 1/150 - 240 PA	07.340.1053.0	50
Cross connector, from E-Cu	for 2 blocks	VB RFK 1/185/2	07.201.4227.0	10
	for 3 blocks	VB RFK 1/185/3	07.201.4327.0	10
	for 4 blocks	VB RFK 1/185/4	07.201.4427.0	10

RFK 1/185... S35

- High current block for mounting on TS 35
- Nominal cross section 185 mm²



Description	Type	Part No.	Std. Pack
Feed-through block	gray F	RFK 1/185 F S 35	56.398.0055.0
	FM	RFK 1/185 FM S 35	56.398.1055.0

GENERAL DATA			
Width / length / height, incl. TS 7.5	see list		
Wire strip length	27 mm		
Approvals			

TECHNICAL DATA	IEC	UL	CSA
For use with insulating sleeves	EN 60947-7-1		
Cross section fine-stranded	70 - 200 mm ²		
Cross section solid/stranded	70 - 200 mm ²		
Cross section, AWG		0 - 400 kcmil	0 - 400 kcmil
Rated current	353 A	375 A	375 A
Rated voltage	1000 V	600 V	600 V
Rated impulse voltage	8 kV		
Pollution degree	3		

ACCESSORIES	Type	Part No.	Std. Pack
Cover for RFK 1/..., yellow	AD RFK 150 - 240	Z7.409.5853.0	10
Partition / end plate	2.8mm thick TE/RFK 1/150 - 240 PA	07.340.1053.0	50
Cross connector, from E-Cu	for 2 blocks	VB RFK 1/185/2	07.201.4227.0
	for 3 blocks	VB RFK 1/185/3	07.201.4327.0
	for 4 blocks	VB RFK 1/185/4	07.201.4427.0

RFK 1/240... S35

- High current block for mounting on TS 35
- Nominal cross section 240 mm²
- * Use only cable lugs type DIN 46234



Description	Type	Part No.	Std. Pack
Feed-through block	gray F	RFK 1/240 F S 35*	56.399.0055.0
	K	RFK 1/240 K S 35	56.399.0155.0
	FK	RFK 1/240 FK S 35*	56.399.0255.0
	FM	RFK 1/240 FM S 35*	56.399.1055.0
	FMK	RFK 1/240 FMK S 35*	56.399.1255.0

GENERAL DATA			
Width / length / height, incl. TS 7.5	see list		
Wire strip length	27 mm		
Approvals			

TECHNICAL DATA	IEC	UL	CSA
For use with insulating sleeves	EN 60947-7-1		
Cross section fine-stranded	70 - 240 mm ²		
Cross section solid/stranded	70 - 240 mm ²		
Cross section, AWG		0 - 500 kcmil	3/0 - 500 kcmil
Rated current	415 A	375 A	425 A
Rated voltage	1000 V	600 V	600 V
Rated impulse voltage	8 kV		
Pollution degree	3		

ACCESSORIES	Type	Part No.	Std. Pack
Cover for RFK 1/..., yellow	AD RFK 150 - 240	Z7.409.5853.0	10
Partition / end plate	2.8mm thick TE/RFK 1/150 - 240 PA	07.340.1053.0	50
Cross connector, from E-Cu	for 2 blocks	VB RFK 1/240/2	07.201.8227.0
	for 3 blocks	VB RFK 1/240/3	07.201.8327.0
	for 4 blocks	VB RFK 1/240/4	07.201.8427.0

CONFIGURATIONS

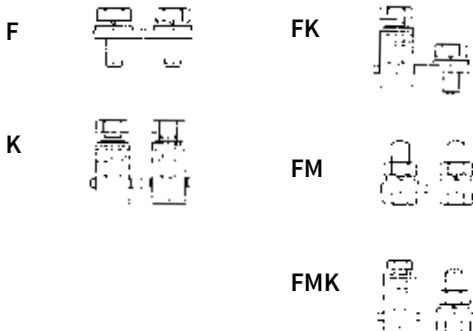



mm ²	Type	Screw	Width mm	Length mm	Height, incl. TS 7.5 mm
95	F	M 10	32	92	55
	FM	M 10	32	92	65
	K, FK, FMK	M 10	32	92	78
150	F	M 12	42	92	55
	K, FK, FMK	M 12	42	92	78
185	F	M 12	42	92	55
	FM	M 12	42	92	70
240	F	M 12	42	92	55
	FM	M 12	42	92	77
	K, FK, FMK	M 12	42	92	93

SELOS · MINI BLOCKS WITH SCREW CONNECTION FOR TS 15

WKM 2,5/15

- Feed-through block for mounting on TS 15
- Nominal cross section 2.5 mm²
- Ex e I/II  II 2GD IM2
Follow the EX installation instructions on page 160





Description	Type	Part No.	Std. Pack
Feed-through block	gray	WKM 2,5/15	55.503.1053.0 100
Feed-through block	blue	WKM 2,5/15 BLAU	55.503.1053.6 100
GENERAL DATA			
Width / length / height, incl. TS 7.5	5 mm / 32 mm / 32 mm		
Wire strip length	9 mm		
Approvals	   USA-Ex CAN-Ex		KEMA 02 ATEX 2114 U
TECHNICAL DATA			
	IEC	UL	CSA
	EN 60 947-7-1		
Cross section fine-stranded	0.5 – 2.5 mm ²		EN 60 079-0/-7
Cross section solid/stranded	0.5 – 4 mm ²		0.5 – 4 mm ²
Cross section, AWG	22 – 14		24 – 12
Rated current	25 A	10 A	25 A 20 A
Rated voltage	500 V	300 V	600 V 275 V
Rated impulse voltage	6 kV		
Pollution degree	3		
ACCESSORIES			
Description	Type	Part No.	Std. Pack
End plate	gray	APM 2,5 - 4/15	07.311.0853.0 10
	blue	APM 2,5 - 4/15 BLAU	07.311.0853.6 10
Partition	gray	TWM 2,5 - 4/15	07.311.1853.0 10
Cross connector with screws,	2-pole	VB WKM 2,5/15-2	Z7.215.4227.0 50
E-Cu	3-pole	VB WKM 2,5/15-3	Z7.215.4327.0 50
	up to 6-pole	VB WKM 2,5/15-6	Z7.215.4627.0 50
	60-pole	VB WKM 2,5/15 M60	Z7.215.4027.0 10
Single cover f. cross conn. with marking facility	AD VB 2,5/15 GELB		04.326.3053.8 10
Partition plate with marking facility	TSM 2,5/15		07.311.2853.8 10

WKM 4/15

- Feed-through block for mounting on TS 15
- Nominal cross section 4 mm²
- Ex e I/II  II 2GD IM2
Follow the EX installation instructions on page 160
- ²⁾ with/without jumper





Description	Type	Part No.	Std. Pack
Feed-through block	gray	WKM 4/15	55.504.1053.0 100
Feed-through block	blue	WKM 4/15 BLAU	55.504.1053.6 100
GENERAL DATA			
Width / length / height, incl. TS 7.5	6 mm / 32 mm / 32 mm		
Wire strip length	9 mm		
Approvals	   USA-Ex CAN-Ex		KEMA 02 ATEX 2114 U
TECHNICAL DATA			
	IEC	UL	CSA
	EN 60 947-7-1		
Cross section fine-stranded	0.5 – 4 mm ²		EN 60 079-0/-7
Cross section solid/stranded	0.5 – 6 mm ²		0.5 – 6 mm ²
Cross section, AWG	22 – 10		20 – 10
Rated current	28 A	30 A	37 A 21/27 A ²⁾
Rated voltage	500 V	600 V	600 V 275 V
Rated impulse voltage	6 kV		
Pollution degree	3		
ACCESSORIES			
Description	Type	Part No.	Std. Pack
End plate	gray	APM 2,5 - 4/15	07.311.0853.0 10
	blue	APM 2,5 - 4/15 BLAU	07.311.0853.6 10
Partition	gray	TWM 2,5 - 4/15	07.311.1853.0 10
Cross connector with screws,	2-pole	IVB WK 4 E/U-2	Z7.271.2227.0 10
E-Cu	3-pole	IVB WK 4 E/U-3	Z7.271.2327.0 10
	up to 12-pole	IVB WK 4 E/U-12	Z7.271.3227.0 10
Single cover f. cross conn. with marking facility	AD VB 4/15 GELB		04.326.2953.8 10
Partition plate with marking facility	TSM 4/15		07.311.2953.8 10

WKM 4 SL/15

- Ground block for mounting on TS 15
- Nominal cross section 4 mm²
- Ex e I/II  II 2GD IM2
Follow the EX installation instructions on page 160



Description	Type	Part No.	Std. Pack
Ground block	green/yellow	WKM 4 SL/15	55.504.9153.0 100
GENERAL DATA			
Width / length / height, incl. TS 7.5	6 mm / 32 mm / 32 mm		
Wire strip length	9 mm		
Approvals	   USA-Ex CAN-Ex		KEMA 02 ATEX 2114 U
TECHNICAL DATA			
	IEC	UL	CSA
	EN 60 947-7-2		
Cross section fine-stranded	0.5 – 4 mm ²		EN 60 079-0/-7
Cross section solid/stranded	0.5 – 6 mm ²		0.5 – 6 mm ²
Cross section, AWG	22 – 14		22 – 10
Rated current	30 A		
Rated voltage	500 V	300 V	
Rated impulse voltage	6 kV		
Pollution degree	3		
ACCESSORIES			
Description	Type	Part No.	Std. Pack
End plate	gray	APM 4 SL/15	07.311.0753.0 10

SELOS BIT – TERMINAL BLOCKS FOR ELECTRICAL INSTALLATIONS

selos – these are terminal blocks with screw connection, solid and functional, known worldwide, and used millions of times over.

The selos series combines the advantages of the classic screw connection with modern connection technology, with the focus on customer benefits and increased efficiency in wiring and logistics.



SPACE-SAVING WIRING

- Clear wiring and assignment of electrical circuits through three-tier design in 6 mm assembly width
- Neutral conductor, phase feed-through, and ground connection in just one terminal
- Safety and convenience through switchable N disconnect function



SAFE AND MAINTENANCE-FREE CONNECTION

- Stable terminal body design with single-part thread
- Multi-wire connection
- Connect with and without wire end ferrule
- Safety and operating convenience even with N-separation using screwable slide-gate valve



COMBINABLE IN THE SYSTEM

- Problem-free combination of installation terminals with other Wieland terminal blocks, also with different connection equipment
- For example:
 - Circuit wiring with compact spring-force device fasis BIT
 - Power feed with proven selos screws
- Low storage and logistics expense due to uniform accessories

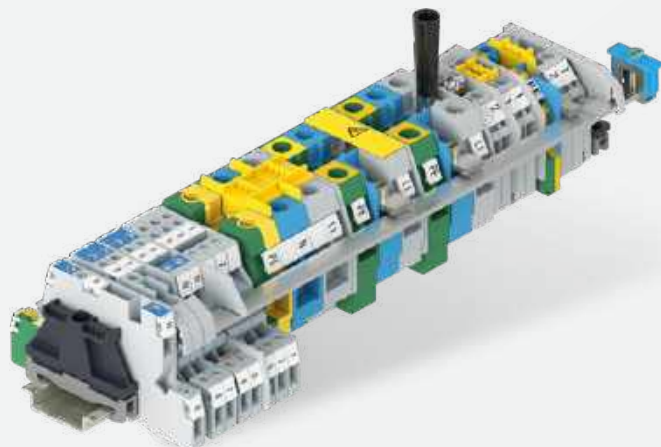



PERFORMANCE FEATURES

- + Connection cross-section: up to 50 mm²
- + Rated current: up to 125 A IEC / 95 A UL / 110 A CSA
- + Rated voltage: up to 400 V IEC / 600 V UL

SELOS BIT · NEUTRAL DISCONNECT TERMINALS FOR INSTALLATION DISTRIBUTION BOARDS WITH SCREW CONNECTION

WT 4 NT

- Neutral disconnect block with screw connection for mounting on TS 35
- Nominal cross section 4 mm²

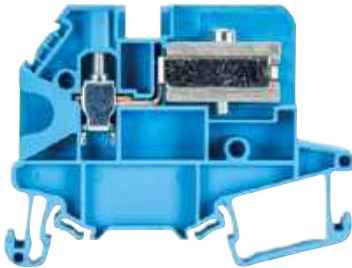

Description	Type	Part.No.	Std. Pack
Neutral disconnect terminal	blue WT 4 NT	58.504.6155.0	100

GENERAL DATA

Width / length / height, incl. TS 7.5	6 mm / 62.6 mm / 48.6 mm
Wire strip length	9 mm
Approvals	Ⓢ

TECHNICAL DATA

	IEC
	EN 60 947-7-2
Cross section fine-stranded	0.14-6 mm ²
Cross section solid/stranded	0.14-6 mm ²
Cross-section, AWG	
Rated current	32 A
Rated voltage	400 V
Rated impulse voltage	6 kV
Pollution degree	3

ACCESSORIES

	Type	Part.No.	Std. Pack
End plate	AP WT 4 NT	07.313.4355.0	1
Busbar	9813 M 10X3 1000MM	98.290.0000.0	1
	9813 M SN 10X3 1000MM	98.290.1000.0	1
Connection clamp for busbar	WAK16/2 BL/V0	30.494.3021.6	100
Connection clamp for busbar	WAK35/2 BL/V0	30.494.4021.6	100
Connection clamp for busbar	WAK35/2	30.494.4121.0	50

WKI 10 ETK

- Neutral disconnect block with screw connection for mounting on TS 35 and TS 32
- Nominal cross section 10 mm²

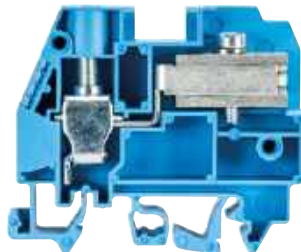

Description	Type	Part.No.	Std. Pack
Neutral disconnect terminal	blue WKI 10 ETK/U/V0	57.510.8255.0	50

GENERAL DATA

Width / length / height, incl. TS 7.5	10 mm / 58 mm / 51.5 mm
Wire strip length	13 mm
Approvals	Ⓢ

TECHNICAL DATA

	IEC	CSA
	EN 60 947-7-2	
Cross section fine-stranded	1-10 mm ²	
Cross section solid/stranded	1-16 mm ²	
Cross-section, AWG		16-6 AWG
Rated current	45 A	
Rated voltage	400 V	600 V
Rated impulse voltage	6 kV	
Pollution degree	3	

ACCESSORIES

	Type	Part.No.	Std. Pack
End plate	API 10-16 ETK/1/V0	07.312.1955.0	10
Busbar	9813 M 10X3 1000MM	98.290.0000.0	1
	9813 M SN 10X3 1000MM	98.290.1000.0	1
Connection clamp for busbar	WAK16/2 BL/V0	30.494.3021.6	100
Connection clamp for busbar	WAK35/2 BL/V0	30.494.4021.6	100
Connection clamp for busbar	WAK35/2	30.494.4121.0	50

WKI 16 ETK

- Neutral disconnect block with screw connection for mounting on TS 35 and TS 32
- Nominal cross section 16 mm²

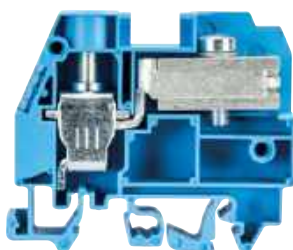

Description	Type	Part.No.	Std. Pack
Neutral disconnect terminal	blue WKI 16 ETK/U/V0	57.516.8255.0	50

GENERAL DATA

Width / length / height, incl. TS 7.5	12 mm / 58 mm / 51.5 mm
Wire strip length	15 mm
Approvals	Ⓢ

TECHNICAL DATA

	IEC	CSA
	EN 60 947-7-2	
Cross section fine-stranded	1-16 mm ²	
Cross section solid/stranded	1-25 mm ²	
Cross-section, AWG		14-4 AWG
Rated current	62 A	
Rated voltage	400 V	600 V
Rated impulse voltage	6 kV	
Pollution degree	3	

ACCESSORIES

	Type	Part.No.	Std. Pack
End plate	API 10-16 ETK/1/V0	07.312.1955.0	10
Busbar	9813 M 10X3 1000MM	98.290.0000.0	1
	9813 M SN 10X3 1000MM	98.290.1000.0	1
Connection clamp for busbar	WAK16/2 BL/V0	30.494.3021.6	100
Connection clamp for busbar	WAK35/2 BL/V0	30.494.4021.6	100
Connection clamp for busbar	WAK35/2	30.494.4121.0	50

SELOS BIT · TERMINAL BLOCKS FOR INSTALLATION DISTRIBUTION BOARDS IN COMPACT DESIGN

WKI 10

- Feed-through block with screw connection for mounting on TS 35 and TS 32
- Nominal cross section 10 mm²



Description	Type	Part.No.	Std. Pack	
Feed-through terminal	gray	WKI 10 / U/V0	57.510.1155.0	50
	blue	WKI 10 / U BLAU/V0	57.510.1155.6	50
Feed-through terminal block green/yellow	WKI 10 SL / 35/V0	56.510.9255.0	50	

GENERAL DATA			
Width / length / height, incl. TS 7.5	10 mm / 58 mm / 51,5 mm		
Wire strip length	18 mm		
Approvals			

TECHNICAL DATA	IEC	UL	CSA
	EN 60 947-7-1		
Cross section fine-stranded	1-10 mm ²		
Cross section solid/stranded	1.5-16 mm ²		
Cross-section, AWG		16-6 AWG	16-6 AWG
Rated current	57 A	65 A	70 A
Rated voltage	400 V	600 V	600 V
Rated impulse voltage	6 kV		
Pollution degree	3		

ACCESSORIES	Type	Part.No.	Std. Pack	
End plate	API 10 - 16/V0	07.311.9455.0	10	
Insulated jumper bar	2-pole	IVBWKN10 - 2	27.283.2227.0	10
	3-pole	IVBWKN10 - 3	27.283.2327.0	10
	4-pole	IVBWKN10 - 4	27.283.2427.0	10
	5-pole	IVBWKN10 - 5	27.283.2527.0	10

WKI 16

- Feed-through block with screw connection for mounting on TS 35 and TS 32
- Nominal cross section 16 mm²



Description	Type	Part.No.	Std. Pack	
Feed-through terminal	gray	WKI 16 / U/V0	57.516.1155.0	50
	blue	WKI 16 / U BLAU/V0	57.516.1155.6	50
Feed-through terminal block green/yellow	WKI 16 SL / 35/V0	56.516.9255.0	50	

GENERAL DATA			
Width / length / height, incl. TS 7.5	12 mm / 58 mm / 51,5 mm		
Wire strip length	16 mm		
Approvals			

TECHNICAL DATA	IEC	UL	CSA
	EN 60 947-7-1		
Cross section fine-stranded	1-16 mm ²		
Cross section solid/stranded	1.5-25 mm ²		
Cross-section, AWG		12-4 AWG	14-4 AWG
Rated current	76 A	65 / 90 A	95 A
Rated voltage	400 V	600 V	600 V
Rated impulse voltage	6 kV		
Pollution degree	3		

ACCESSORIES	Type	Part.No.	Std. Pack	
End plate	API 10 - 16/V0	07.311.9455.0	10	
Insulated jumper bar	2-pole	IVB WKI16- 2	27.284.9227.0	10
	3-pole	IVB WKI16- 3	27.284.9327.0	10
	4-pole	IVB WKI16- 4	27.284.9427.0	10
	5-pole	IVB WKI16- 5	27.284.9527.0	10

WKI 35

- Feed-through block with screw connection for mounting on TS 35 and TS 32
- Nominal cross section 35 mm²

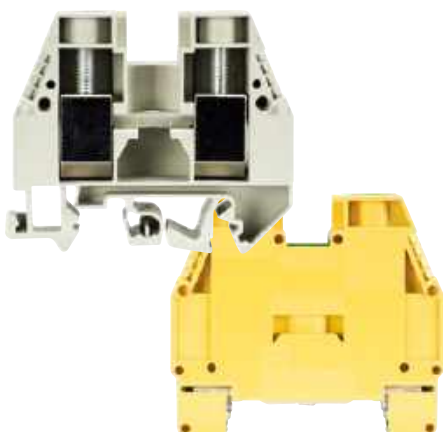

Description	Type	Part.No.	Std. Pack	
Feed-through terminal	gray	WKI 35 / U/V0	57.535.1155.0	20
	blue	WKI 35 / U BLAU/V0	57.535.1155.6	20
Feed-through terminal block green/yellow	WKI 35 SL / 35/V0	56.535.9255.0	20	

GENERAL DATA			
Width / length / height, incl. TS 7.5	16 mm / 58 mm / 51,5 mm		
Wire strip length	13 mm		
Approvals			

TECHNICAL DATA	IEC	UL	CSA
	EN 60 947-7-1		
Cross section fine-stranded	6-35 mm ²		
Cross section solid/stranded	6-50 mm ²		
Cross-section, AWG		10-2 AWG	10-2 AWG
Rated current	125 A	95 A	110 A
Rated voltage	400 V	600 V	600 V
Rated impulse voltage	6 kV		
Pollution degree	3		

ACCESSORIES	Type	Part.No.	Std. Pack	
End plate	API 35/V0	07.311.8855.0	10	
Insulated jumper bar	2-pole	IVBWKI35 - 2	27.285.4227.0	5
	3-pole	IVBWKI35 - 3	27.285.4327.0	5
	4-pole	IVBWKI35 - 4	27.285.4427.0	5
	5-pole	IVBWKI35 - 5	27.285.4527.0	5

Technical information see FACTS & DATA page 158 ff.

Subject to technical modifications

More feed-through and ground blocks are on page 14 and the following

SELOS BIT · MULTI-TIER TERMINALS FOR INSTALLATION DISTRIBUTION BOARDS WITH SCREW CONNECTION

WKI 4 DU

WKI 4 D-D

- Installation multi-tier terminal with screw connection for mounting on TS 35
- Nominal cross section 4 mm²
- Model DU: one busbar below



Description	Type	Part.No.	Std. Pack
Installation rail terminal blocks	WKI 4 DU /V0	56.404.9655.0	50
Installation rail terminal blocks	WKI 4 D-D /V0	56.404.9755.0	50

GENERAL DATA			
Width / length / height, incl. TS 7.5	6 mm / 90 mm / 51.5 mm		
Wire strip length	7 mm		
Approvals			
TECHNICAL DATA			
	IEC	UL	CSA
	EN 60 947-7-1		
Cross section fine-stranded	0.5-4 mm ²		
Cross section solid/stranded	0.5 - 6 mm ²		
Cross-section, AWG		22-10 AWG	22-10 AWG
Rated current	26 A	24 A	25 A
Rated voltage	400 V	300 V	300 V
Rated impulse voltage	6 kV		
Pollution degree	3		

ACCESSORIES				
	Type	Part.No.	Std. Pack	
End plate	API 4/2/V0	07.311.6555.0	10	
Partition	TWI 4/V0	07.311.6955.0	10	
Jumper bar	2-pole 9703 / 6- 2	Z7.211.0227.0	50	
	5-pole 9703 / 6- 5	Z7.211.0527.0	50	
	insulated 12-pole	IVB WKI 4-12	Z7.271.5227.0	10
	sold by the meter 70-pole	9703 / 6 M-70	Z7.211.0027.0	10

WKI 4 D-D-SL

WKI 4 N-D-SL

- Installation multi-tier terminal with screw connection for mounting on TS 35
- Nominal cross section 4 mm²



Description	Type	Part.No.	Std. Pack
Installation rail terminal blocks	WKI 4 D-D-SL /V0	56.404.9855.0	50
Installation rail terminal blocks	WKI 4 N-D-SL /V0	56.404.9455.0	50

GENERAL DATA			
Width / length / height, incl. TS 7.5	6 mm / 90 mm / 51.5 mm		
Wire strip length	7 mm		
Approvals			
TECHNICAL DATA			
	IEC	UL	CSA
	EN 60 947-7-1		
Cross section fine-stranded	0.5-4 mm ²		
Cross section solid/stranded	0.5 - 6 mm ²		
Cross-section, AWG		22-10 AWG	22-10 AWG
Rated current	26 A	24 A	25 A
Rated voltage	400 V	300 V	300 V
Rated impulse voltage	6 kV		
Pollution degree	3		

ACCESSORIES				
	Type	Part.No.	Std. Pack	
End plate	API 4/2/V0	07.311.6555.0	10	
Partition	TWI 4/V0	07.311.6955.0	10	
Jumper bar	2-pole 9703 / 6- 2	Z7.211.0227.0	50	
	5-pole 9703 / 6- 5	Z7.211.0527.0	50	
	insulated 12-pole	IVB WKI 4-12	Z7.271.5227.0	10
	sold by the meter 70-pole	9703 / 6 M-70	Z7.211.0027.0	10

WKI 4 NT-D-SL

- Installation multi-tier terminal with screw connection for mounting on TS 35
- Nominal cross section 4 mm²



Description	Type	Part.No.	Std. Pack
Installation rail terminal blocks	WKI 4 NT -D-SL /V0	56.404.9555.0	50
Installation rail terminal blocks	WKI 4 NT -D-SL GL/V0	56.404.9255.0	50

GENERAL DATA			
Width / length / height, incl. TS 7.5	6 mm / 90 mm / 51.5 mm		
Wire strip length	7 mm		
Approvals			
TECHNICAL DATA			
	IEC	UL	CSA
	EN 60 947-7-1		
Cross section fine-stranded	0.5-4 mm ²		
Cross section solid/stranded	0.5 - 6 mm ²		
Cross-section, AWG		22-10 AWG	22-10 AWG
Rated current	26 A	24 A	25 A
Rated voltage	400 V	300 V	300 V
Rated impulse voltage	6 kV		
Pollution degree	3		

ACCESSORIES				
	Type	Part.No.	Std. Pack	
End plate	API 4/2/V0	07.311.6555.0	10	
Jumper bar	2-pole 9703 / 6- 2	Z7.211.0227.0	50	
	3-pole 9703 / 6- 3	Z7.211.0327.0	50	
	insulated 12-pole	IVB WKI 4-12	Z7.271.5227.0	10
	sold by the meter 70-pole	9703 / 6 M-70	Z7.211.0027.0	10
Busbar	9813 M 10X 3 1000MM	98.290.0000.0	1	
	9813 M SN 10X3 1000MM	98.290.1000.0	1	

WKI 4 NTN-D-SL

- Installation multi-tier terminal with screw connection for mounting on TS 35
- Nominal cross section 4 mm²
- The busbar cannot pass by on the outside. These two terminals should therefore be placed at the start or end of a terminal group.



Description	Type	Part.No.	Std. Pack
Installation rail terminal blocks	WKI 4 NTN-D-SL /V0	56.404.9155.0	50
GENERAL DATA			
Width / length / height, incl. TS 7.5	6 mm / 90 mm / 51.5 mm		
Wire strip length	7 mm		
Approvals			
TECHNICAL DATA			
	IEC	UL	CSA
	EN 60 947-7-1		
Cross section fine-stranded	0.5-4 mm ²		
Cross section solid/stranded	0.5 - 6 mm ²		
Cross-section, AWG	22-10 AWG	22-10 AWG	
Rated current	26 A	24 A	25 A
Rated voltage	400 V	300 V	300 V
Rated impulse voltage	6 kV		
Pollution degree	3		
ACCESSORIES			
	Type	Part.No.	Std. Pack
End plate	API 4/3/V0	07.311.6855.0	10
Jumper bar	2-pole 9703 / 6- 2	Z7.211.0227.0	50
	3-pole 9703 / 6- 3	Z7.211.0327.0	50
	insulated 12-pole IVB WKI 4-12	Z7.271.5227.0	10
	sold by the meter 70-pole 9703 / 6 M-70	Z7.211.0027.0	10

WKI 4 TKG-D-SL

- Multi-tier fuse terminal with screw connection for mounting on TS 35
- Nominal cross section 4 mm²
- The busbar cannot pass by on the outside. The terminal should therefore be placed at the start or end of a terminal group.



Description	Type	Part.No.	Std. Pack
Installation rail terminal blocks	WKI 4 TKG-D-SL /V0	56.404.8855.0	50
GENERAL DATA			
Width / length / height, incl. TS 7.5	6 mm / 90 mm / 51.5 mm		
Wire strip length	7 mm		
Approvals			
TECHNICAL DATA			
	IEC	UL	CSA
	EN 60 947-7-1		
Cross section fine-stranded	0.5-4 mm ²		
Cross section solid/stranded	0.5 - 6 mm ²		
Cross-section, AWG	22-10 AWG	22-10 AWG	
Rated current	26 A	12 A	12 A
Rated voltage	400 V	300 V	300 V
Rated impulse voltage	6 kV		
Pollution degree	3		
ACCESSORIES			
	Type	Part.No.	Std. Pack
End plate	API 4/3/V0	07.311.6855.0	10
Jumper bar	2-pole 9703 / 6- 2	Z7.211.0227.0	50
	5-pole 9703 / 6- 5	Z7.211.0527.0	50
	insulated 12-pole IVB WKI 4-12	Z7.271.5227.0	10
	sold by the meter 70-pole 9703 / 6 M-70	Z7.211.0027.0	10

FUSE HOLDER

- Fuse holder for built-in in WKI 4 TKG-DSL
- Nominal current in accordance with VDE 0820 T2/ EN 60 127-2 with use of 1.6 W – 6.3 A, for individual terminal – 4 A with terminals directly next to each other
- Voltage and current are determined through the installed lamp display and the fuse insert used.

Description	Type	Part.No.	Std. Pack
Fuse holder for fuse 5 x 20	Si ST	Z1.299.4055.0	10
Fuse holder with indicator (24 V)	Si ST LED	Z1.299.4155.0	10
Fuse holder with indicator (220 V)	Si ST GL	Z1.299.4255.0	10

FASIS WKFN – DIN RAIL TERMINAL BLOCKS WITH TENSION SPRING CONNECTION

fasis WKFN are DIN rail terminal block with tension spring technology:

They are easy to operate, saves time and costs during wiring and reduces inventory costs, and guarantees vibration-proof and maintenance-free connections with high contact forces.

fasis WKFN has been designed for use in machinery and plant construction as well as hazardous locations subject to explosion.

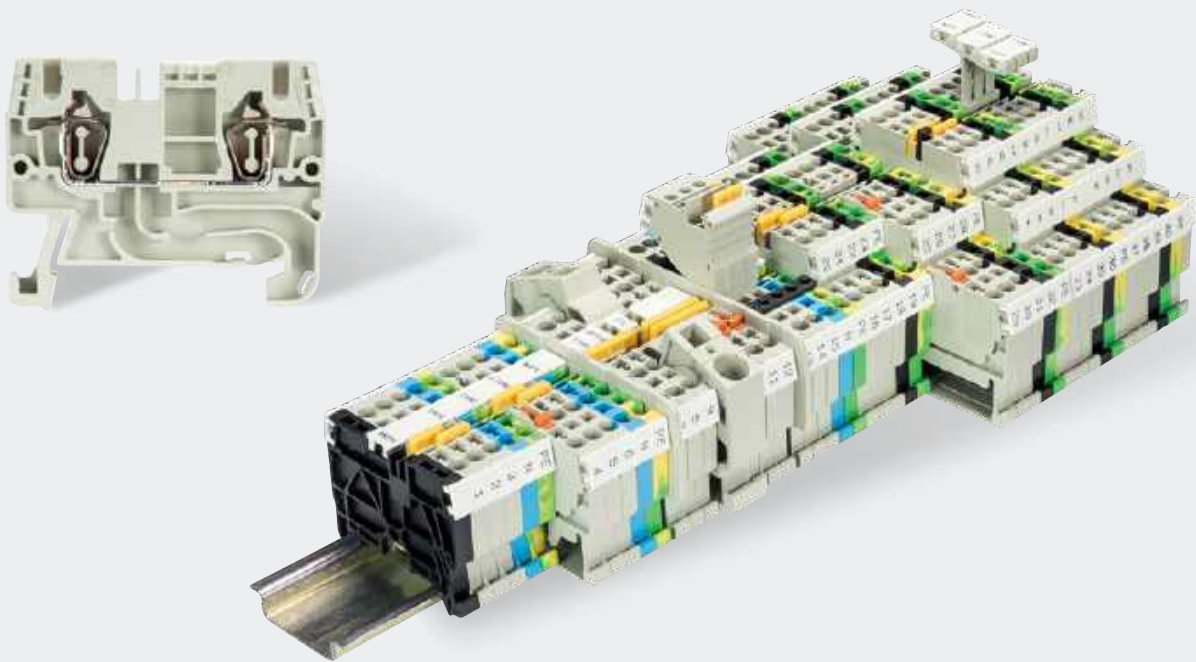

- + Includes Feed-through and ground blocks with 2, 3 or 4 termination point
- + Multi-tier blocks in two- and three-tier designs
- + Knife-edge disconnect blocks in one- and two-tier designs and fuse blocks
- + Specialty function blocks are available with application-specific diode circuits



PERFORMANCE FEATURES

- + Connection cross-sections: up to 35 mm²
- + Rated current: up to 125 A IEC / 115 A UL, CSA
- + Rated voltage: up to 800 V IEC / 600 V UL, CSA

FASIS – DIN RAIL TERMINAL BLOCKS WITH TENSION SPRING CONNECTION

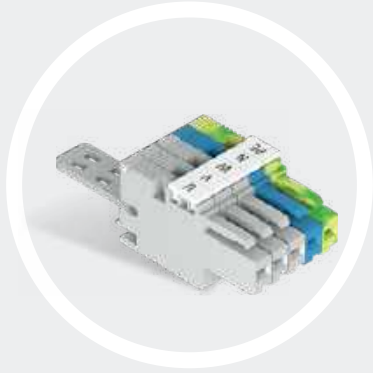

Plug & Play in the control cabinet

- Plug-in system – fasisCON
- 32 A and 4 mm² on only 5 mm width

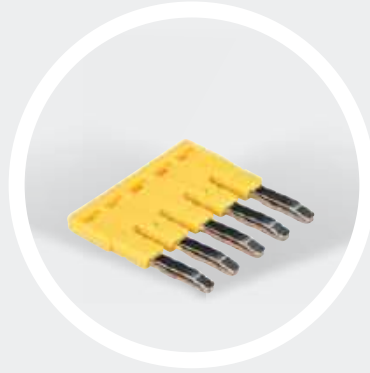

Completing the Concept

- Dual jumpering channels
- Plug-in jumper bars
- Potential distribution by supply block up to 76 A

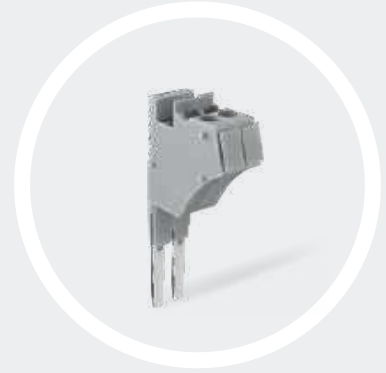

Easy testing

- Function check via modular test adapter
- Integrated test jacks in all blocks

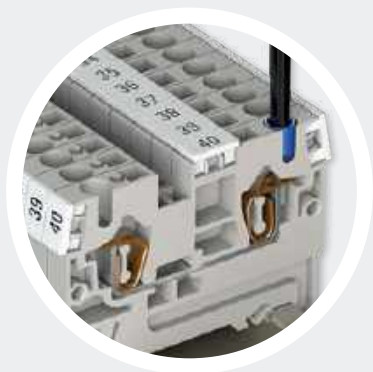

FEATURES

- + Vibration-proof
- + Maintenance-free
- + High contact force

Durable and maintenance-free connection

- Tension spring connection resistant to vibration
- Connect with and without ferrules

Fine-stranded wire perfectly connected

- Simple operation with a standard screwdriver
- Screwdriver is held securely in the terminal for optimal handling while connecting wires



JUMPERING SYSTEM – PERFECT TECHNOLOGY

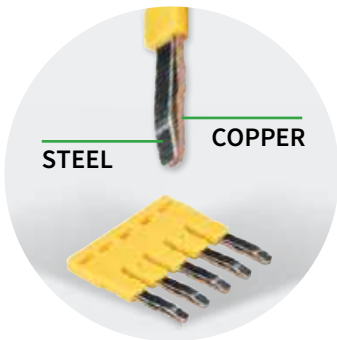

Perfect technology

- Copper current bar guarantees low contact resistance
- Steel spring guarantees strength, durability, and long-term stability



Extremely rugged!

- Indestructible steel spring
- Vibration-proof connection



Simple customization

- Individual-poles easy to remove
- Circuits easy to identify

ACCESSORIES + MARKING SYSTEM SAFELY CONNECT + IDENTIFY



The accessories

- Snap-on covers with warning symbols
- Wieland screwdriver for optimal operation of spring tension terminals
- Wire entry guide strips for secure connection of wires smaller than 1 mm²



Marking tags – Individual

- Individual labeling with minimum effort
- Ideal for service and maintenance



Marking strips – Dependable

- Maximum hold to the terminal
- Solidify integrity of rail assembly



FASIS WKFN · FEED-THROUGH BLOCKS WITH TENSION SPRING CONNECTION

WKF 1,5/35

- Feed-through block with tension spring connection for mounting on TS 35
- Nominal cross section 1.5 mm²
- Ex e II  II 2GD
Follow the EX installation instructions on page 160



Description	Type	Part No.	Std. Pack
Feed-through block	gray WKF 1,5/35	56.702.0053.0	50
Feed-through block	blue WKF 1,5/35 BLAU	56.702.0053.6	50



GENERAL DATA				
Width / length / height, incl. TS 7.5	4 mm / 49 mm / 37 mm			
Wire strip length	10 mm			
Approvals	ATEX  		KEMA 03 ATEX 2056 U	
TECHNICAL DATA				
	IEC	UL	CSA	
	EN 60 947-7-1			
Cross section fine-stranded	0.08 – 1.5 mm ²		EN 60 079-0/-7	
Cross section solid/stranded	0.08 – 1.5 mm ²		0.14 – 1.5 mm ²	
Cross section, AWG	26 – 14		26 – 14	
Rated current	17.5 A	15 A	15 A	17.5/16.5 A ¹⁾
Rated voltage	500 V	300 V	300 V	440 V ^{*)}
Rated impulse voltage	6 kV			
Pollution degree	3			
ACCESSORIES				
End plate	gray APF 1,5		07.312.8153.0	10

WKF 1,5 D1/2/35

- Duo feed-through block with tension spring connection for mounting on TS 35
- Nominal cross section 1.5 mm²
- Ex e II  II 2GD
Follow the EX installation instructions on page 160



Description	Type	Part No.	Std. Pack
Feed-through block	gray WKF 1,5 D1/2/35	56.702.5053.0	50
Feed-through block	blue WKF 1,5 D1/2/35 BLAU	56.702.5053.6	50



GENERAL DATA				
Width / length / height, incl. TS 7.5	4 mm / 60 mm / 37 mm			
Wire strip length	10 mm			
Approvals	ATEX  		KEMA 03 ATEX 2056 U	
TECHNICAL DATA				
	IEC	UL	CSA	
	EN 60 947-7-1			
Cross section fine-stranded	0.08 – 1.5 mm ²		EN 60 079-0/-7	
Cross section solid/stranded	0.08 – 1.5 mm ²		0.14 – 1.5 mm ²	
Cross section, AWG	26 – 14		26 – 14	
Rated current	17.5 A	15 A	15 A	17.5/16.5 A ¹⁾
Rated voltage	500 V	300 V	300 V	440 V ^{*)}
Rated impulse voltage	6 kV			
Pollution degree	3			
ACCESSORIES				
End plate	gray APF 1,5 D1/2		07.312.8353.0	10

WKF 1,5 D2/2/35

- Duo feed-through block with tension spring connection for mounting on TS 35
- Nominal cross section 1.5 mm²
- Ex e II  II 2GD
Follow the EX installation instructions on page 160



Description	Type	Part No.	Std. Pack
Feed-through block	gray WKF 1,5 D2/2/35	56.702.5153.0	50
Feed-through block	blue WKF 1,5 D2/2/35 BLAU	56.702.5153.6	50

GENERAL DATA				
Width / length / height, incl. TS 7.5	4 mm / 72 mm / 37 mm			
Wire strip length	10 mm			
Approvals	ATEX  		KEMA 03 ATEX 2056 U	
TECHNICAL DATA				
	IEC	UL	CSA	
	EN 60 947-7-1			
Cross section fine-stranded	0.08 – 1.5 mm ²		EN 60 079-0/-7	
Cross section solid/stranded	0.08 – 1.5 mm ²		0.14 – 1.5 mm ²	
Cross section, AWG	26 – 14		26 – 14	
Rated current	17.5 A	15 A	15 A	17.5/16.5 A ¹⁾
Rated voltage	500 V	300 V	300 V	440 V ^{*)}
Rated impulse voltage	6 kV			
Pollution degree	3			
ACCESSORIES				
End plate	gray APF 1,5 D2/2		07.312.8553.0	10

¹⁾ For maintaining the proper isolation distances, the open side of a feed-through terminal block as well as both sides of a jumper are to be covered by partitions.
^{*)} without/with jumper

ACCESSORIES FOR FASIS WKF 1,5



Accessories	Type	Part No.	Std. Pack
Cross connector, insulated	2-pole IVB WKF 1,5-2	Z7.268.0227.0	10
	3-pole IVB WKF 1,5-3	Z7.268.0327.0	10
	4-pole IVB WKF 1,5-4	Z7.268.0427.0	10
	5-pole IVB WKF 1,5-5	Z7.268.0527.0	10
	10-pole IVB WKF 1,5-10	Z7.268.1027.0	10
Screwdriver, uninsulated	DIN 5264 B 0,4x2,5	06.502.4300.0	5

Technical information see FACTS & DATA page 158 ff.

Subject to technical modifications

FASIS WKFN · FEED-THROUGH BLOCKS WITH TENSION SPRING CONNECTION

WKFN 2,5/35

- Feed-through block with tension spring connection for mounting on TS 35
- Nominal cross section 2.5 mm²
- Ex e I/II  II 2GD IM2
Follow the EX installation instructions on page 160



Description	Type	Part No.	Std. Pack
Feed-through block	gray WKFN 2,5/35	56.703.0055.0	100
Feed-through block	blue WKFN 2,5/35 BLAU	56.703.0055.6	100

GENERAL DATA			
Width / length / height, incl. TS 7.5	5 mm / 47 mm / 38 mm		
Wire strip length	11 mm		
Approvals	PTB     USA-Ex CAN-Ex		PTB 04 ATEX 1051 U

TECHNICAL DATA	IEC	UL	CSA	
	EN 60 947-1-1			
Cross section fine-stranded	0.13 – 2.5 mm ²			EN 60 079-0/-7
Cross section solid/stranded	0.13 – 4 mm ²			0.2 – 2.5 mm ²
Cross section, AWG		22 – 12	24 – 12	
Rated current	24 A	20 A	24 A	22/21 A ¹⁾
Rated voltage	800 V	600 V	600 V	550 V
Rated impulse voltage	8 kV			
Pollution degree	3			

Note ¹⁾ solid/fine-stranded

ACCESSORIES	Type	Part No.	Std. Pack
End plate	gray APFN 2,5	07.312.6755.0	10
End plate	blue APFN 2,5 BLAU	07.312.6755.6	10
Partition	gray TWFN 2,5	07.312.6855.0	10

WKFN 2,5 D1/2/35

- Duo feed-through block with tension spring connection for mounting on TS 35
- Nominal cross section 2.5 mm²
- Ex e I/II  II 2GD IM2
Follow the EX installation instructions on page 160



Description	Type	Part No.	Std. Pack
Feed-through block	gray WKFN 2,5 D1/2/35	56.703.5055.0	100
Feed-through block	blue WKFN 2,5 D1/2/35 BLAU	56.703.5055.6	100

GENERAL DATA			
Width / length / height, incl. TS 7.5	5 mm / 60 mm / 38 mm		
Wire strip length	11 mm		
Approvals	PTB     USA-Ex CAN-Ex		PTB 04 ATEX 1051 U

TECHNICAL DATA	IEC	UL	CSA	
	EN 60 947-1-1			
Cross section fine-stranded	0.13 – 2.5 mm ²			EN 60 079-0/-7
Cross section solid/stranded	0.13 – 4 mm ²			0.2 – 2.5 mm ²
Cross section, AWG		22 – 12	24 – 12	
Rated current	24 A	20 A	24 A	22/21 A ¹⁾
Rated voltage	800 V	600 V	600 V	550 V
Rated impulse voltage	8 kV			
Pollution degree	3			

Note ¹⁾ solid/fine-stranded

ACCESSORIES	Type	Part No.	Std. Pack
End plate	gray APFN 2,5 D1/2	07.312.6955.0	10
End plate	blue APFN 2,5 D1/2 BLAU	07.312.6955.6	10
Partition	gray TWFN 2,5 D1/2	07.312.7055.0	10

WKFN 2,5 D2/2/35

- Duo feed-through block with tension spring connection for mounting on TS 35
- Nominal cross section 2.5 mm²
- Ex e I/II  II 2GD IM2
Follow the EX installation instructions on page 160



Description	Type	Part No.	Std. Pack
Feed-through block	gray WKFN 2,5 D2/2/35	56.703.5155.0	100
Feed-through block	blue WKFN 2,5 D2/2/35 BLAU	56.703.5155.6	100

GENERAL DATA			
Width / length / height, incl. TS 7.5	5 mm / 72 mm / 38 mm		
Wire strip length	11 mm		
Approvals	PTB     USA-Ex CAN-Ex		PTB 04 ATEX 1051 U

TECHNICAL DATA	IEC	UL	CSA	
	EN 60 947-1-1			
Cross section fine-stranded	0.13 – 2.5 mm ²			EN 60 079-0/-7
Cross section solid/stranded	0.13 – 4 mm ²			0.2 – 2.5 mm ²
Cross section, AWG		22 – 12	24 – 12	
Rated current	24 A	20 A	24 A	22/21 A ¹⁾
Rated voltage	800 V	600 V	600 V	550 V
Rated impulse voltage	8 kV			
Pollution degree	3			

Note ¹⁾ solid/fine-stranded



ACCESSORIES	Type	Part No.	Std. Pack
End plate	gray APFN 2,5 D2/2	07.312.7155.0	10
End plate	blue APFN 2,5 D2/2 BLAU	07.312.7155.6	10
Partition	gray TWFN 2,5 D2/2	07.312.7255.0	10

FASIS WKFN · SUPPLY BLOCK

WKF 16/35 PV/WKFN

- Supply block for mounting on TS 35
- Nominal cross section 16 mm²
- Ex e I/II  II 2GD IM2
Follow the EX installation instructions on page 160



Description	Type	Part No.	Std. Pack
Power feed-in block	gray WKF 16/35 PV/WKFN	56.716.0353.0	20
GENERAL DATA			
Width / length / height, incl. TS 7.5	12 mm / 82 mm / 48 mm		
Wire strip length	15 mm		
Approvals	  ATEX		KEMA 01 ATEX 2087 U
TECHNICAL DATA			
	IEC	UL	CSA
	EN 60 947-7-1		EN 60 079-0/-7
Cross section fine-stranded	4 – 16 mm ²		4 – 16 mm ²
Cross section solid/stranded	4 – 16 mm ²		4 – 16 mm ²
Cross section, AWG	24 – 4		12 – 4
Rated current	76 A	75 A	78 A
Rated voltage	800 V	600 V	600 V
Rated impulse voltage	8 kV		690 V
Pollution degree	3		
Note	* Type-specific output currents upon request		
ACCESSORIES			
	Type	Part No.	Std. Pack
Cover with warning symbol over 4 blocks	ADF 16/4 GELB	04.343.6653.8	10
Screwdriver, uninsulated	DIN 5264 B 1,0x5,5	06.502.4200.0	5

- Potential distribution with standard cross connector IVB WKF 2.5...
- Parallel connection of two cross connectors -> double jumpering
- Potential distributions are possible on one or both sides

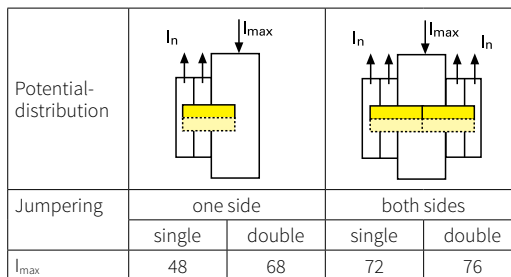

$$I_{\max} = \sum I_n \leq \sum I_{N \text{ block}}$$

ACCESSORIES FOR FASIS WKFN 2,5

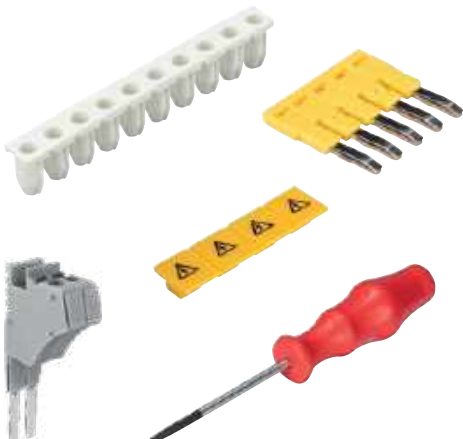

ACCESSORIES	Type	Part No.	Std. Pack
Cross connector, insulated	2-pole IVB WKF 2,5 – 2	Z7.280.6227.0	10
	3-pole IVB WKF 2,5 – 3	Z7.280.6327.0	10
	4-pole IVB WKF 2,5 – 4	Z7.280.6427.0	10
	5-pole IVB WKF 2,5 – 5	Z7.280.6527.0	10
	6-pole IVB WKF 2,5 – 6	Z7.280.6627.0	10
	7-pole IVB WKF 2,5 – 7	Z7.280.6727.0	20
	8-pole IVB WKF 2,5 – 8	Z7.280.6827.0	20
	9-pole IVB WKF 2,5 – 9	Z7.280.6927.0	20
	10-pole IVB WKF 2,5 – 10	Z7.280.7027.0	20
	20-pole IVB WKF 2,5 – 20	Z7.280.8027.0	20
Wire entry guide	0.13 – 0.2 mm ² LELN 2,5/1 WEISS	05.564.3755.0	100
	0.25 – 0.5 mm ² LELN 2,5/2 GRAU	05.564.3855.0	100
	0.75 – 1.0 mm ² LELN 2,5/3 SCHWARZ	05.564.3955.0	100
Cover with warning symbol over 4 blocks	yellow ADFN 2,5/4 GELB	04.343.8353.8	10
Test adapter, modular	PS WKCF	Z1.299.9753.0	10
Test plug	ST 2/2,3	Z5.553.2921.0	10
Screwdriver, uninsulated	DIN 5264 B 0,6x3,5	06.502.4000.0	5
Screwdriver, uninsulated, MINI	DIN 5264 B 0,6x3,5 M	06.502.5000.0	10

Technical information see FACTS & DATA page 158 ff.

Subject to technical modifications

FASIS WKFN · FEED-THROUGH BLOCKS WITH TENSION SPRING CONNECTION

WKFN 4/35

- Feed-through block with tension spring connection for mounting on TS 35
- Nominal cross section 4 mm²
- Ex e I/II  II 2GD IM2
Follow the EX installation instructions on page 160



Description	Type	Part No.	Std. Pack
Feed-through block	gray WKFN 4/35	56.704.0055.0	100
Feed-through block	blue WKFN 4/35 BLAU	56.704.0055.6	100

GENERAL DATA			
Width / length / height, incl. TS 7.5	6 mm / 51 mm / 38 mm		
Wire strip length	11 mm		
Approvals	PTB    CAN-Ex		PTB 05 ATEX 1104 U

TECHNICAL DATA	IEC	UL	CSA	
	EN 60 947-7-1			
Cross section fine-stranded	0.13 – 4 mm ²			EN 60 079-0/-7
Cross section solid/stranded	0.13 – 6 mm ²			0.13 – 4 mm ²
Cross section, AWG		24 – 10	24 – 10	0.2 – 6 mm ²
Rated current	32 A	30 A	32 A	28 A
Rated voltage	800 V	600 V	600 V	690 V
Rated impulse voltage	8 kV			
Pollution degree	3			

ACCESSORIES	Type	Part No.	Std. Pack
End plate	gray APFN 4	07.312.9255.0	10
End plate	blue APFN 4 BLAU	07.312.9255.6	10
Partition	gray TWFN 4	07.312.9355.0	10

WKFN 4 D1/2/35

- Duo feed-through block with tension spring connection for mounting on TS 35
- Nominal cross section 4 mm²
- Ex e I/II  II 2GD IM2
Follow the EX installation instructions on page 160



Description	Type	Part No.	Std. Pack
Feed-through block	gray WKFN 4 D1/2/35	56.704.5055.0	100
Feed-through block	blue WKFN 4 D1/2/35 BLAU	56.704.5055.6	100

GENERAL DATA			
Width / length / height, incl. TS 7.5	6 mm / 67 mm / 38 mm		
Wire strip length	11 mm		
Approvals	PTB    CAN-Ex		PTB 05 ATEX 1104 U

TECHNICAL DATA	IEC	UL	CSA	
	EN 60 947-7-1			
Cross section fine-stranded	0.13 – 4 mm ²			EN 60 079-0/-7
Cross section solid/stranded	0.13 – 6 mm ²			0.13 – 4 mm ²
Cross section, AWG		24 – 10	24 – 10	0.2 – 6 mm ²
Rated current	32 A	30 A	32 A	28 A
Rated voltage	800 V	600 V	600 V	550 V
Rated impulse voltage	8 kV			
Pollution degree	3			

ACCESSORIES	Type	Part No.	Std. Pack
End plate	gray APFN 4 D1/2	07.312.9455.0	10
End plate	blue APFN 4 D1/2 BLAU	07.312.9455.6	10
Partition	gray TWFN 4 D1/2	07.312.9555.0	10

WKFN 4 D2/2/35

- Duo feed-through block with tension spring connection for mounting on TS 35
- Nominal cross section 4 mm²
- Ex e I/II  II 2GD IM2
Follow the EX installation instructions on page 160



Description	Type	Part No.	Std. Pack
Feed-through block	gray WKFN 4 D2/2/35	56.704.5155.0	100
Feed-through block	blue WKFN 4 D2/2/35 BLAU	56.704.5155.6	100

GENERAL DATA			
Width / length / height, incl. TS 7.5	6 mm / 82 mm / 38 mm		
Wire strip length	11 mm		
Approvals	PTB    CAN-Ex		PTB 05 ATEX 1104 U

TECHNICAL DATA	IEC	UL	CSA	
	EN 60 947-7-1			
Cross section fine-stranded	0.13 – 4 mm ²			EN 60 079-0/-7
Cross section solid/stranded	0.13 – 6 mm ²			0.13 – 4 mm ²
Cross section, AWG		24 – 10	24 – 10	0.2 – 6 mm ²
Rated current	32 A	30 A	32 A	28 A
Rated voltage	800 V	600 V	600 V	550 V
Rated impulse voltage	8 kV			
Pollution degree	3			

ACCESSORIES	Type	Part No.	Std. Pack
End plate	gray APFN 4 D2/2	07.312.9055.0	10
End plate	blue APFN 4 D2/2 BLAU	07.312.9055.6	10
Partition	gray TWFN 4 D2/2	07.312.9155.0	10

WKF 16/35 PV/WKFN

- Supply block for mounting on TS 35
- Nominal cross section 16 mm²
- Ex e I/II  II 2GD IM2
Follow the EX installation instructions on page 160



Description	Type	Part No.	Std. Pack	
Power feed-in block	gray	WKF 16/35 PV/WKFN	56.716.0353.0	20

GENERAL DATA

Width / length / height, incl. TS 7.5	12 mm / 82 mm / 48 mm			
Wire strip length	15 mm			
Approvals				KEMA 01 ATEX 2087 U

TECHNICAL DATA

	IEC	UL	CSA	
	EN 60 947-7-1			EN 60 079-0/-7
Cross section fine-stranded	4 – 16 mm ²			
Cross section solid/stranded	4 – 16 mm ²			
Cross section, AWG		24 – 4	12 – 4	
Rated current	76 A	75 A	78 A	64 A*
Rated voltage	800 V	600 V	600 V	690 V
Rated impulse voltage	8 kV			
Pollution degree	3			

Note

* Type-specific output currents upon request

ACCESSORIES

	Type	Part No.	Std. Pack
Cover with warning symbol over 4 blocks	ADF 16/4 GELB	04.343.6653.8	10
Screwdriver, uninsulated	DIN 5264 B 1,0x5,5	06.502.4200.0	5

- Potential distribution with standard cross connector IVB WKF 4...
- Parallel connection of two cross connectors -> double jumpering
- Potential distributions are possible on one or both sides

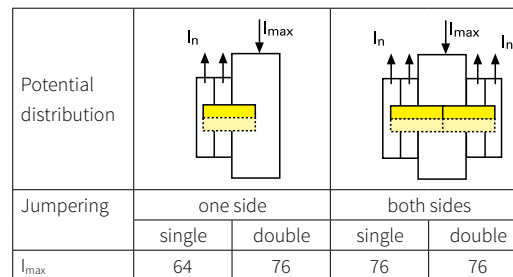

$$I_{\max} = \sum I_n \leq \sum I_{N \text{ block}}$$

ACCESSORIES FOR FASIS WKFN 4



ACCESSORIES	Type	Part No.	Std. Pack	
Cross connector, insulated	2-pole	VB WKF 4-2	Z7.261.1227.0	10
	3-pole	IVB WKF 4-3	Z7.261.1327.0	10
	4-pole	IVB WKF 4-4	Z7.261.1427.0	10
	5-pole	IVB WKF 4-5	Z7.261.1527.0	10
	6-pole	IVB WKF 4-6	Z7.261.1627.0	10
	7-pole	IVB WKF 4-7	Z7.261.1727.0	20
	8-pole	IVB WKF 4-8	Z7.261.1827.0	20
	9-pole	IVB WKF 4-9	Z7.261.1927.0	20
	10-pole	IVB WKF 4-10	Z7.261.2027.0	20
	Wire entry guide	0.13 – 0.2 mm ²	LEL 4/1 WEISS	05.561.8553.0
0.25 – 0.5 mm ²		LEL 4/2 GRAU	05.561.8653.0	100
0.75 – 1.0 mm ²		LEL 4/3 SCHWARZ	05.561.8753.0	100
Cover with warning symbol over 4 blocks	yellow	ADF 4/4 GELB	04.343.6153.8	10
Test adapter, modular		PS WKC/F	Z1.299.9753.0	10
Test plug		ST 2/2,3	Z5.553.2921.0	10
Screwdriver, uninsulated		DIN 5264 B 0,6x3,5	06.502.4000.0	5
Screwdriver, uninsulated, MINI		DIN 5264 B 0,6x3,5 M	06.502.5000.0	10

Technical information see FACTS & DATA page 158 ff.

Subject to technical modifications

FASIS WKFN · FEED-THROUGH BLOCKS WITH TENSION SPRING CONNECTION

WKFN 6/35

- Feed-through block with tension spring connection for mounting on TS 35
- Nominal cross section 6 mm²
- Ex e I/II  II 2GD IM2
Follow the EX installation instructions on page 160



Description	Type	Part No.	Std. Pack
Feed-through block	gray WKFN 6/35	56.706.0055.0	100
Feed-through block	blue WKFN 6/35 BLAU	56.706.0055.6	100

GENERAL DATA				
Width / length / height, incl. TS 7.5	8 mm / 66 mm / 45 mm			
Wire strip length	12 mm			
Approvals	PTB    			PTB 06 ATEX 1075 U

TECHNICAL DATA	IEC	UL	CSA	
	EN 60 947-7-1			
Cross section fine-stranded	0.2 – 6 mm ²			EN 60 079-0/-7
Cross section solid/stranded	1.5 – 10 mm ²			1.5 – 10 mm ²
Cross section, AWG		24 – 8	24 – 8	
Rated current	41 A	50 A	41 A	39/34 A ¹⁾
Rated voltage	800 V	600 V	600 V	550 V
Rated impulse voltage	8 kV			
Pollution degree	3			

Note ¹⁾ solid/fine-stranded

ACCESSORIES	Type	Part No.	Std. Pack
End plate	gray APFN 6	07.313.0455.0	10
End plate	blue APFN 6 BLAU	07.313.0455.6	10
Partition	gray TWFN 6	07.313.0555.0	10

WKFN 6 D1/2/35

- Duo-feed-through block with tension spring connection for mounting on TS 35
- Nominal cross section 6 mm²
- Ex e I/II  II 2GD IM2
Follow the EX installation instructions on page 160



Description	Type	Part No.	Std. Pack
Feed-through block	gray WKFN 6 D1/2/35	56.706.5055.0	100
Feed-through block	blue WKFN 6 D1/2/35 BLAU	56.706.5055.6	100

GENERAL DATA				
Width / length / height, incl. TS 7.5	8 mm / 90 mm / 45 mm			
Wire strip length	12 mm			
Approvals	PTB    			PTB 06 ATEX 1075 U

TECHNICAL DATA	IEC	UL	CSA	
	EN 60 947-7-1			
Cross section fine-stranded	0.2 – 6 mm ²			EN 60 079-0/-7
Cross section solid/stranded	1.5 – 10 mm ²			1.5 – 10 mm ²
Cross section, AWG		24 – 8	24 – 8	
Rated current	41 A	50 A	41 A	39/34 A ¹⁾
Rated voltage	800 V	600 V	600 V	550 V
Rated impulse voltage	8 kV			
Pollution degree	3			

Note ¹⁾ solid/fine-stranded

ACCESSORIES	Type	Part No.	Std. Pack
End plate	gray APFN 6 D1/2	07.313.0655.0	10
End plate	blue APFN 6 D1/2 BLAU	07.313.0655.6	10
Partition	gray TWFN 6 D1/2	07.313.0755.0	10

ACCESSORIES FOR FASIS WKFN 6

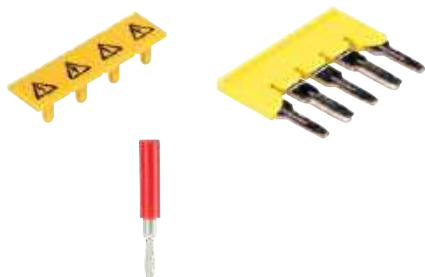

ACCESSORIES	Type	Part No.	Std. Pack
Cross connector, insulated**	2-pole IVB WKFN 6 – 2	Z7.282.5227.0	10
	3-pole IVB WKFN 6 – 3	Z7.282.5327.0	10
	4-pole IVB WKFN 6 – 4	Z7.282.5427.0	10
	5-pole IVB WKFN 6 – 5	Z7.282.5527.0	10
	Cover with warning symbol over 4 blocks	yellow ADF 6/4 GELB	04.343.6253.8
Test plug	ST 2/2,3	Z5.553.2921.0	10
Screwdriver, uninsulated	DIN 5264 B 0,8x4	06.502.4100.0	5





** When cross connectors are used according to EN 60079-0 and EN 60079-7, the current must be reduced to max. 3.5 A.

WKFN 10/35

- Feed-through block with tension spring connection for mounting on TS 35
 - Nominal cross section 10 mm²
 - Ex e I/II  II 2GD IM2
Follow the EX installation instructions on page 160
- ³⁾ Pls. note that the current must be reduced for EX applications.



Description	Type	Part No.	Std. Pack
Feed-through block	gray WKFN 10/35	56.710.0055.0	50
Feed-through block	blue WKFN 10/35 BLAU	56.710.0055.6	50

GENERAL DATA					
Width / length / height, incl. TS 7.5	10 mm / 72 mm / 50 mm				
Wire strip length	15 mm				
Approvals	PTB    			PTB 06 ATEX 1075 U	
TECHNICAL DATA		IEC	UL	CSA	
		EN 60 947-7-1			EN 60 079-0/-7
Cross section fine-stranded	0.2 – 10 mm ²			0.2 – 10 mm ²	
Cross section solid/stranded	1.5 – 16 mm ²			1.5 – 16 mm ²	
Cross section, AWG			16 – 6	16 – 6	
Rated current	57 A	60 A	65 A	52/47 A ¹⁾	
Rated voltage	800 V	600 V	600 V	550 V	
Rated impulse voltage	8 kV				
Pollution degree	3				
Note					¹⁾ solid/fine-stranded





ACCESSORIES	Type	Part No.	Std. Pack
End plate	gray APFN 10	07.313.0855.0	10
End plate	blue APFN 10 BLAU	07.313.0855.6	10
Partition	gray TWFN 10	07.313.0955.0	10

WKFN 10 D1/2/35

- Duo-feed-through block with tension spring connection for mounting on TS 35
 - Nominal cross section 10 mm²
 - Ex e I/II  II 2GD IM2
Follow the EX installation instructions on page 160
- ³⁾ Pls. note that the current must be reduced for EX applications.



Description	Type	Part No.	Std. Pack
Feed-through block	gray WKFN 10 D1/2/35	56.710.5055.0	50
Feed-through block	blue WKFN 10 D1/2/35 BLAU	56.710.5055.6	50

GENERAL DATA					
Width / length / height, incl. TS 7.5	10 mm / 98 mm / 50 mm				
Wire strip length	15 mm				
Approvals	PTB    			PTB 06 ATEX 1075 U	
TECHNICAL DATA		IEC	UL	CSA	
		EN 60 947-7-1			EN 60 079-0/-7
Cross section fine-stranded	0.2 – 10 mm ²			0.2 – 10 mm ²	
Cross section solid/stranded	1.5 – 16 mm ²			1.5 – 16 mm ²	
Cross section, AWG			16 – 6	16 – 6	
Rated current	57 A	60 A	65 A	52/47 A ¹⁾	
Rated voltage	1000 V	600 V	600 V	550 V	
Rated impulse voltage	8 kV				
Pollution degree	3				
Note					¹⁾ solid/fine-stranded

ACCESSORIES	Type	Part No.	Std. Pack
End plate	gray APFN 10 D1/2	07.313.1055.0	10
End plate	blue APFN 10 D1/2 BLAU	07.313.1055.6	10
Partition	gray TWFN 10 D1/2	07.313.1155.0	10

ACCESSORIES FOR FASIS WKFN 10

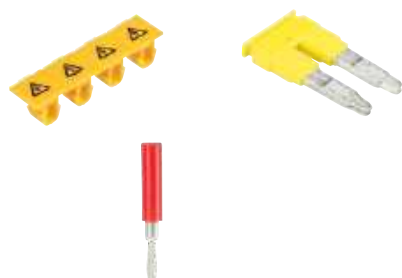

ACCESSORIES	Type	Part No.	Std. Pack
Cross connector, insulated**	2-pole IVB WKF 10 – 2	Z7.283.8227.0	10
Reducing jumper, WKF 35 to WKFN 10 ³⁾	IVB WKFN 35R10	Z7.285.6427.0	10
Cover with warning symbol over 4 blocks	yellow ADF 10/4 GELB	04.343.6453.8	10
Test plug	ST 2/2,3	Z5.553.2921.0	10
Screwdriver, uninsulated	DIN 5264 B 1x5,5	06.502.4200.0	5

** When cross connectors are used acc. to EN 60079-0 and EN 60079-7 the current must be reduced to 4 A/40 K or 5 A/45 K for type WKFN 10/35.

FASIS WKFN · FEED-THROUGH BLOCKS WITH TENSION SPRING CONNECTION

WKFN 16/35

- Feed-through block with tension spring connection for mounting on TS 35
- Nominal cross section 16 mm²
- Ex e I/II  II 2GD IM2
Follow the EX installation instructions on page 160



Description	Type	Part No.	Std. Pack
Feed-through block	gray WKFN 16/35	56.716.0055.0	50
Feed-through block	blue WKFN 16/35 BLAU	56.716.0055.6	100

GENERAL DATA				
Width / length / height, incl. TS 7.5	12 mm / 79 mm / 50 mm			
Wire strip length	16 mm			
Approvals	PTB 			PTB 06 ATEX 1075 U

TECHNICAL DATA	IEC	UL	CSA	
	EN 60 947-7-1			
Cross section fine-stranded	0.2 – 16 mm ²			
Cross section solid/stranded	1.5 – 25 mm ²			
Cross section, AWG		16 – 4	16 – 4	
Rated current	76 A	85 A	85 A	74/68 A ¹⁾
Rated voltage	1000 V	600 V	600 V	550 V
Rated impulse voltage	8 kV			
Pollution degree	3			

Note ¹⁾ solid/fine-stranded

ACCESSORIES	Type	Part No.	Std. Pack
End plate	gray APFN 16	07.313.1255.0	10
End plate	blue APFN 16 BLAU	07.313.1255.6	10
Partition	gray TWFN 16	07.313.1355.0	10
Cross connector, insulated**	2-pole IVB WKF 16 – 2	Z7.284.4227.0	10
Cover with warning symbol for 4 blocks	ADF 16/4 GELB	04.343.6653.8	10

WKFN 16 D1/2/35

- Duo-feed-through block with tension spring connection for mounting on TS 35
- Nominal cross section 16 mm²
- Ex e I/II  II 2GD IM2
Follow the EX installation instructions on page 160

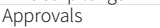

Description	Type	Part No.	Std. Pack
Feed-through block	gray WKFN 16 D1/2/35	56.716.5055.0	50
Feed-through block	blue WKFN 16 D1/2/35 BLAU	56.716.5055.6	100

GENERAL DATA				
Width / length / height, incl. TS 7.5	12 mm / 107 mm / 50 mm			
Wire strip length	16 mm			
Approvals	PTB 			PTB 06 ATEX 1075 U

TECHNICAL DATA	IEC	UL	CSA	
	EN 60 947-7-1			
Cross section fine-stranded	0.2 – 16 mm ²			
Cross section solid/stranded	1.5 – 25 mm ²			
Cross section, AWG		16 – 4	16 – 4	
Rated current	76 A	85 A	85 A	74/68 A ¹⁾
Rated voltage	1000 V	600 V	600 V	550 V
Rated impulse voltage	8 kV			
Pollution degree	3			

Note ¹⁾ solid/fine-stranded

ACCESSORIES	Type	Part No.	Std. Pack
End plate	gray APFN 16 D1/2	07.313.1455.0	10
End plate	blue APFN 16 D1/2 BLAU	07.313.1455.6	10
Partition	gray TWFN 16 D1/2	07.313.1555.0	10
Cross connector, insulated**	2-pole IVB WKF 16 – 2	Z7.284.4227.0	10
Cover with warning symbol for 4 blocks	ADF 16/4 GELB	04.343.6653.8	10

WKF 35/35

- Feed-through block with tension spring connection for mounting on TS 35
- Nominal cross section 35 mm²
- Ex e II  II 2GD
Follow the EX installation instructions on page 160



Description	Type	Part No.	Std. Pack
Feed-through block	gray WKF 35/35	56.735.0053.0	10
Feed-through block	blue WKF 35/35 BLAU	56.735.0053.6	10

GENERAL DATA				
Width / length / height, incl. TS 7.5	16 mm / 100 mm / 59 mm			
Wire strip length	25 mm			
Approvals	ATEX 			KEMA 03 ATEX 2057 U

TECHNICAL DATA	IEC	UL	CSA	
	EN 60 947-7-1			
Cross section fine-stranded	2.5 – 35 mm ²			
Cross section solid/stranded	2.5 – 35 mm ²			
Cross section, AWG		12 – 2	12 – 2	
Rated current	125 A	115 A	115 A	92/108 A ¹⁾
Rated voltage	800 V	600 V	600 V	690 V
Rated impulse voltage	8 kV			
Pollution degree	3			

Note ¹⁾ with/without jumper

ACCESSORIES	Type	Part No.	Std. Pack
Cross connector, insulated	2-pole IVB WKF 35-2	Z7.285.6227.0	10

FASIS WKFN · POTENTIAL SUPPLY WITH FEED-THROUGH BLOCKS UP TO 35 MM²

$I_{max E}$: $I_{max, supply}$
 $I_{max R}$: $I_{reducing cross connector}$
 I_{N-A} : I_N output terminal blocks

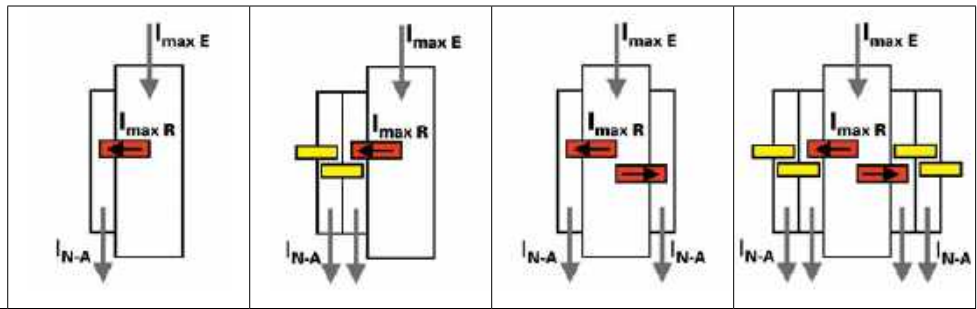

Potential distribution	Distribution on one side		Distribution on both sides	
	2-poles	several poles	2-poles	several poles
35-R-10 $I_{max, supply}$	125 A	125 A	125 A	125 A
$I_{reducing cross connector}$	57 A	105 A	57 A	105 A
I_N output terminal blocks	57 A	57 A	57 A	57 A

POTENTIAL DISTRIBUTION 35 R 10

- Potential supply 35 mm²
- Reducing cross connector 35R10
- Potential output 10 mm²

Function	Type	Part No.	Std. Pack
Supply block	gray WKF 35 /35	56.735.0053.0	10
Supply block	gray WKF 35 /35 BLAU	56.735.0053.6	10
Reducing cross connector ²⁾	IVB WKFN 35R10	27.285.6427.0	10
Output block	gray WKFN 10 /35	56.710.0055.0	10
Output block	blue WKFN 10 /35 BLAU	56.710.0055.6	10
Output block	gray WKFN 10 D1/2/35	56.710.5055.0	10
Output block	blue WKFN 10 D1/2/35 BLAU	56.710.5055.6	10

²⁾ When cross connectors are used acc. to EN 60079-0 and EN 60079-7 the current must be reduced (values to be requested)

ACCESSORIES FOR FASIS WKFN 16 AND WKF 35



ACCESSORIES	Type	Part No.	Std. Pack
Test plug	ST 2/2,3	Z5.553.2921.0	10
Screwdriver, uninsulated	DIN 5264 B 1x5,5	06.502.4200.0	5



** When cross connectors are used according to EN 60079-0 and EN 60079-7, the current must be reduced to max. 3.5 A.

FASIS WKFN · GROUND BLOCKS WITH TENSION SPRING CONNECTION

WKF 1,5 SL/35

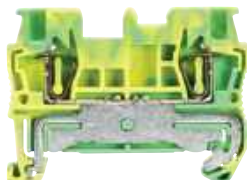
- Ground block with tension spring connection for mounting on TS 35
- Nominal cross section 1.5 mm²
- Ex e I/II  II 2GD IM2
Follow the EX installation instructions on page 160





Description	Type	Part No.	Std. Pack
Ground block	green/yellow WKF 1,5 SL/35	56.702.9053.0	50
GENERAL DATA			
Width / length / height, incl. TS 7.5	4 mm / 49 mm / 37 mm		
Wire strip length	10 mm		
Approvals	ATEX   KEMA 03 ATEX 2056 U		
TECHNICAL DATA	IEC	UL	CSA 
	EN 60 947-7-2		
Cross section fine-stranded	0.08 – 1.5 mm ²		
Cross section solid/stranded	0.08 – 1.5 mm ²		
Cross section, AWG	24 – 14		
Rated current	24 – 14		
Rated voltage	500 V	300 V	300 V
Rated impulse voltage	6 kV		
Pollution degree	3		
ACCESSORIES	Type	Part No.	Std. Pack
End plate	gray APF 1,5	07.312.8153.0	10

WKF 1,5 D1/2/SL/35

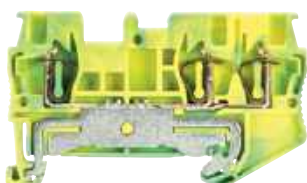
- Duo ground block with tension spring connection for mounting on TS 35
- Nominal cross section 1.5 mm²
- Ex e I/II  II 2GD IM2
Follow the EX installation instructions on page 160





Description	Type	Part No.	Std. Pack
Ground block	green/yellow WKF 1,5 D1/2/SL/35	56.702.9353.0	50
GENERAL DATA			
Width / length / height, incl. TS 7.5	4 mm / 60 mm / 37 mm		
Wire strip length	10 mm		
Approvals	ATEX   KEMA 03 ATEX 2056 U		
TECHNICAL DATA	IEC	UL	CSA 
	EN 60 947-7-2		
Cross section fine-stranded	0.08 – 1.5 mm ²		
Cross section solid/stranded	0.08 – 1.5 mm ²		
Cross section, AWG	24 – 14		
Rated current	24 – 14		
Rated voltage	500 V	300 V	300 V
Rated impulse voltage	6 kV		
Pollution degree	3		
ACCESSORIES	Type	Part No.	Std. Pack
End plate	gray APF 1,5 D1/2	07.312.8353.0	10

WKF 1,5 D2/2/SL/35

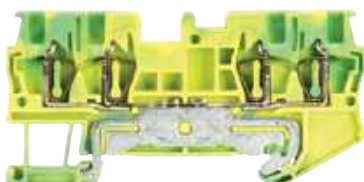
- Duo ground block with tension spring connection for mounting on TS 35
- Nominal cross section 1.5 mm²
- Ex e I/II  II 2GD IM2
Follow the EX installation instructions on page 160



Description	Type	Part No.	Std. Pack
Ground block	green/yellow WKF 1,5 D2/2/SL/35	56.702.9153.0	50
GENERAL DATA			
Width / length / height, incl. TS 7.5	4 mm / 72 mm / 37 mm		
Wire strip length	10 mm		
Approvals	ATEX   KEMA 03 ATEX 2056 U		
TECHNICAL DATA	IEC	UL	CSA 
	EN 60 947-7-2		
Cross section fine-stranded	0.08 – 1.5 mm ²		
Cross section solid/stranded	0.08 – 1.5 mm ²		
Cross section, AWG	24 – 14		
Rated current	24 – 14		
Rated voltage	500 V	300 V	300 V
Rated impulse voltage	6 kV		
Pollution degree	3		
ACCESSORIES	Type	Part No.	Std. Pack
End plate	gray APF 1,5 D2/2	07.312.8553.0	10

ACCESSORIES FOR FASIS WKF 1,5







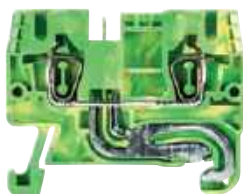

ACCESSORIES	Type	Part No.	Std. Pack
Screwdriver, uninsulated	DIN 5264 B 0,4x2,5	06.502.4300.0	5

* In order to maintain the proper isolation distances, the open side of a ground block is to be covered by an end plate.

WKFN 2,5 SL/35

- Ground block with tension spring connection for mounting on TS 35
- Nominal cross section 2.5 mm²
- Ex e I/II  II 2GD IM2
Follow the EX installation instructions on page 160







Description	Type	Part No.	Std. Pack
Ground block	green/yellow	WKFN 2,5 SL/35	56.703.9055.0 100
GENERAL DATA			
Width / length / height, incl. TS 7.5	5 mm / 47 mm / 38 mm		
Wire strip length	11 mm		
Approvals	PTB     USA-Ex CAN-Ex		PTB 04 ATEX 1051 U
TECHNICAL DATA			
	IEC	UL	CSA 
	EN 60 947-7-2		
Cross section fine-stranded	0.13 – 2.5 mm ²		EN 60 079-0/-7
Cross section solid/stranded	0.13 – 4 mm ²		0.2 – 2.5 mm ²
Cross section, AWG	22 – 12		0.13 – 4 mm ²
Rated current			
Rated voltage	800 V	600 V	600 V
Rated impulse voltage	8 kV		
Pollution degree	3		
ACCESSORIES			
End plate	gray	APFN 2,5	07.312.6755.0 10

WKFN 2,5 D1/2/SL/35

- Duo-Ground block with tension spring connection for mounting on TS 35
- Nominal cross section 2.5 mm²
- Ex e I/II  II 2GD IM2
Follow the EX installation instructions on page 160







Description	Type	Part No.	Std. Pack
Ground block	green/yellow	WKFN 2,5 D1/2/SL/35	56.703.9355.0 100
GENERAL DATA			
Width / length / height, incl. TS 7.5	5 mm / 60 mm / 38 mm		
Wire strip length	11 mm		
Approvals	PTB     USA-Ex CAN-Ex		PTB 04 ATEX 1051 U
TECHNICAL DATA			
	IEC	UL	CSA 
	EN 60 947-7-2		
Cross section fine-stranded	0.13 – 2.5 mm ²		EN 60 079-0/-7
Cross section solid/stranded	0.13 – 4 mm ²		0.2 – 2.5 mm ²
Cross section, AWG	22 – 12		0.13 – 4 mm ²
Rated current			
Rated voltage	800 V	600 V	600 V
Rated impulse voltage	8 kV		
Pollution degree	3		
ACCESSORIES			
End plate	gray	APFN 2,5 D1/2	07.312.6955.0 10

WKFN 2,5 D2/2/SL/35

- Duo ground block with tension spring connection for mounting on TS 35
- Nominal cross section 2.5 mm²
- Ex e I/II  II 2GD IM2
Follow the EX installation instructions on page 160



Description	Type	Part No.	Std. Pack
Ground block	green/yellow	WKFN 2,5 D2/2/SL/35	56.703.9155.0 100
GENERAL DATA			
Width / length / height, incl. TS 7.5	5 mm / 72 mm / 38 mm		
Wire strip length	11 mm		
Approvals	PTB     USA-Ex CAN-Ex		PTB 04 ATEX 1051 U
TECHNICAL DATA			
	IEC	UL	CSA 
	EN 60 947-7-2		
Cross section fine-stranded	0.13 – 2.5 mm ²		EN 60 079-0/-7
Cross section solid/stranded	0.13 – 4 mm ²		0.2 – 2.5 mm ²
Cross section, AWG	22 – 12		0.13 – 4 mm ²
Rated current			
Rated voltage	800 V	600 V	600 V
Rated impulse voltage	8 kV		
Pollution degree	3		
ACCESSORIES			
End plate	gray	APFN 2,5 D2/2	07.312.7155.0 10

ACCESSORIES FOR FASIS WKFN 2,5



ACCESSORIES	Type	Part No.	Std. Pack
Wire entry guide	0.13 – 0.2 mm ²	LELN 2,5/1 WEISS	05.564.3755.0 100
	0.25 – 0.5 mm ²	LELN 2,5/2 GRAU	05.564.3855.0 100
	0.75 – 1.0 mm ²	LELN 2,5/3 SCHWARZ	05.564.3955.0 100
Cover with warning symbol over 4 blocks	yellow	ADFN 2,5/4 GELB	04.343.8353.8 10
Screwdriver, uninsulated		DIN 5264 B 0,6x3,5	06.502.4000.0 5
Screwdriver, uninsulated, MINI		DIN 5264 B 0,6x3,5 M	06.502.5000.0 10

Technical information see FACTS & DATA page 158 ff.





Subject to technical modifications

FASIS WKFN · GROUND BLOCKS WITH TENSION SPRING CONNECTION

WKFN 4 SL/35

- Ground block with tension spring connection for mounting on TS 35
- Nominal cross section 4 mm²
- Ex e I/II  II 2GD IM2
Follow the EX installation instructions on page 160







Description	Type	Part No.	Std. Pack
Ground block	green/yellow WKFN 4 SL/35	56.704.9055.0	100
GENERAL DATA			
Width / length / height, incl. TS 7.5	6 mm / 51 mm / 38 mm		
Wire strip length	11 mm		
Approvals	PTB     CAN-Ex		PTB 05 ATEX 1104 U
TECHNICAL DATA			
	IEC	UL	CSA
			
	EN 60 947-7-2		
Cross section fine-stranded	0.13 – 4 mm ²		EN 60 079-0/-7
Cross section solid/stranded	0.13 – 6 mm ²		0.13 – 4 mm ²
Cross section, AWG	24 – 10		0.2 – 6 mm ²
Rated current	24 – 10		
Rated voltage	800 V	600 V	600 V
Rated impulse voltage	8 kV		
Pollution degree	3		
ACCESSORIES			
	Type	Part No.	Std. Pack
End plate	gray APFN 4	07.312.9255.0	10

WKFN 4 D1/2/SL/35

- Duo ground block with tension spring connection for mounting on TS 35
- Nominal cross section 4 mm²
- Ex e I/II  II 2GD IM2
Follow the EX installation instructions on page 160







Description	Type	Part No.	Std. Pack
Ground block	green/yellow WKFN 4 D1/2/SL/35	56.704.9355.0	100
GENERAL DATA			
Width / length / height, incl. TS 7.5	6 mm / 67 mm / 38 mm		
Wire strip length	11 mm		
Approvals	PTB     CAN-Ex		PTB 05 ATEX 1104 U
TECHNICAL DATA			
	IEC	UL	CSA
			
	EN 60 947-7-2		
Cross section fine-stranded	0.13 – 4 mm ²		EN 60 079-0/-7
Cross section solid/stranded	0.13 – 6 mm ²		0.13 – 4 mm ²
Cross section, AWG	24 – 10		0.2 – 6 mm ²
Rated current	24 – 10		
Rated voltage	800 V	600 V	600 V
Rated impulse voltage	8 kV		
Pollution degree	3		
ACCESSORIES			
	Type	Part No.	Std. Pack
End plate	gray APFN 4 D1/2	07.312.9455.0	10

WKFN 4 D2/2/SL/35

- Duo ground block with tension spring connection for mounting on TS 35
- Nominal cross section 4 mm²
- Ex e I/II  II 2GD IM2
Follow the EX installation instructions on page 160



Description	Type	Part No.	Std. Pack
Ground block	green/yellow WKFN 4 D2/2/SL/35	56.704.9155.0	100
GENERAL DATA			
Width / length / height, incl. TS 7.5	6 mm / 82 mm / 38 mm		
Wire strip length	11 mm		
Approvals	PTB     CAN-Ex		PTB 05 ATEX 1104 U
TECHNICAL DATA			
	IEC	UL	CSA
			
	EN 60 947-7-2		
Cross section fine-stranded	0.13 – 4 mm ²		EN 60 079-0/-7
Cross section solid/stranded	0.13 – 6 mm ²		0.13 – 4 mm ²
Cross section, AWG	24 – 10		0.2 – 6 mm ²
Rated current	24 – 10		
Rated voltage	800 V	600 V	600 V
Rated impulse voltage	8 kV		
Pollution degree	3		
ACCESSORIES			
	Type	Part No.	Std. Pack
End plate	gray APFN 4 D2/2	07.312.9055.0	10

ACCESSORIES FOR FASIS WKFN 4







ACCESSORIES	Type	Part No.	Std. Pack
Wire entry guide	0.13 – 0.2 mm ²	LEL 4/1 WEISS	05.561.8553.0
	0.25 – 0.5 mm ²	LEL 4/2 GRAU	05.561.8653.0
	0.75 – 1.0 mm ²	LEL 4/3 SCHWARZ	05.561.8753.0
Cover with warning symbol over 4 blocks	yellow	ADF 4/4 GELB	04.343.6153.8
Test plug		ST 2/2,3	Z5.553.2921.0
Screwdriver, uninsulated		DIN 5264 B 0,6x3,5	06.502.4000.0
Screwdriver, uninsulated, MINI		DIN 5264 B 0,6x3,5 M	06.502.5000.0

WKFN 6 SL/35

- Ground block with tension spring connection for mounting on TS 35
- Nominal cross section 6 mm²
- Ex e I/II  II 2GD IM2
Follow the EX installation instructions on page 160







Description	Type	Part No.	Std. Pack
Ground block	green/yellow WKFN 6 SL/35	56.706.9055.0	100
GENERAL DATA			
Width / length / height, incl. TS 7.5	8 mm / 66 mm / 45 mm		
Wire strip length	12 mm		
Approvals	PTB     PTB 06 ATEX 1075 U		
TECHNICAL DATA			
	IEC	UL	CSA
			
Cross section fine-stranded	EN 60 947-7-2		
Cross section solid/stranded	EN 60 079-0/-7		
Cross section, AWG	0.2 – 6 mm ²		
Rated current	1.5 – 10 mm ²		
Rated voltage	24 – 8	24 – 8	
Rated impulse voltage	800 V	600 V	600 V
Pollution degree	8 kV		
	3		
ACCESSORIES			
End plate	gray APFN 6	07.313.0455.0	10

WKFN 6 D1/2/SL/35

- Duo ground block with tension spring connection for mounting on TS 35
- Nominal cross section 6 mm²
- Ex e I/II  II 2GD IM2
Follow the EX installation instructions on page 160



Description	Type	Part No.	Std. Pack
Ground block	green/yellow WKFN 6 D1/2/SL/35	56.706.9355.0	100
GENERAL DATA			
Width / length / height, incl. TS 7.5	8 mm / 90 mm / 45 mm		
Wire strip length	12 mm		
Approvals	PTB     PTB 06 ATEX 1075 U		
TECHNICAL DATA			
	IEC	UL	CSA
			
Cross section fine-stranded	EN 60 947-7-2		
Cross section solid/stranded	EN 60 079-0/-7		
Cross section, AWG	0.2 – 6 mm ²		
Rated current	1.5 – 10 mm ²		
Rated voltage	24 – 8	24 – 8	
Rated impulse voltage	800 V	600 V	600 V
Pollution degree	8 kV		
	3		
ACCESSORIES			
End plate	gray APFN 6 D1/2	07.313.0655.0	10

ACCESSORIES FOR FASIS WKFN 6



ACCESSORIES	Type	Part No.	Std. Pack
Cross connector, insulated*	2-pole	IVB WKFN 6 – 2	Z7.282.5227.0
	3-pole	IVB WKFN 6 – 3	Z7.282.5327.0
	4-pole	IVB WKFN 6 – 4	Z7.282.5427.0
	5-pole	IVB WKFN 6 – 5	Z7.282.5527.0
	Cover with warning symbol over 4 blocks	yellow	ADF 6/4 GELB
Test plug		ST 2/2,3	Z5.553.2921.0
Screwdriver, uninsulated		DIN 5264 B 0,8x4	06.502.4100.0





* When cross connectors are used according to EN 60079-0 and EN 60079-7, the current must be reduced to max. 3.5 A.

FASIS WKFN · GROUND BLOCKS WITH TENSION SPRING CONNECTION

WKFN 10 SL/35

- Ground block with tension spring connection for mounting on TS 35
- Nominal cross section 10 mm²
- Ex e I/II  II 2GD IM2
Follow the EX installation instructions on page 160







Description	Type	Part No.	Std. Pack
Ground block	green/yellow	WKFN 10 SL/35	56.710.9055.0 50
GENERAL DATA			
Width / length / height, incl. TS 7.5	10 mm / 72 mm / 50 mm		
Wire strip length	15 mm		
Approvals	PTB   		PTB 06 ATEX 1075 U
TECHNICAL DATA			
	IEC	UL	CSA
			
	EN 60 947-7-2		
Cross section fine-stranded	0.2 – 10 mm ²		EN 60 079-0/-7
Cross section solid/stranded	1.5 – 16 mm ²		0.2 – 10 mm ²
Cross section, AWG	16 – 6		1.5 – 16 mm ²
Rated current	16 – 6		
Rated voltage	1000 V	600 V	600 V
Rated impulse voltage	8 kV		
Pollution degree	3		
ACCESSORIES			
	Type	Part No.	Std. Pack
End plate	gray	APFN 10/35	07.313.0855.0 10

WKFN 10 D1/2/SL/35

- Duo ground block with tension spring connection for mounting on TS 35
- Nominal cross section 10 mm²
- Ex e I/II  II 2GD IM2
Follow the EX installation instructions on page 160





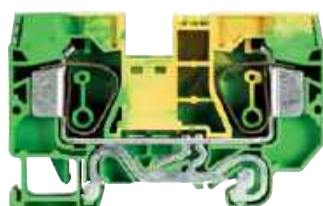

Description	Type	Part No.	Std. Pack
Ground block	green/yellow	WKFN 10 D1/2/SL/35	56.710.9355.0 50
GENERAL DATA			
Width / length / height, incl. TS 7.5	10 mm / 98 mm / 50 mm		
Wire strip length	15 mm		
Approvals	PTB   		PTB 06 ATEX 1075 U
TECHNICAL DATA			
	IEC	UL	CSA
			
	EN 60 947-7-2		
Cross section fine-stranded	0.2 – 10 mm ²		EN 60 079-0/-7
Cross section solid/stranded	1.5 – 16 mm ²		0.2 – 10 mm ²
Cross section, AWG	16 – 6		1.5 – 16 mm ²
Rated current	16 – 6		
Rated voltage	1000 V	600 V	
Rated impulse voltage	8 kV		
Pollution degree	3		
ACCESSORIES			
	Type	Part No.	Std. Pack
End plate	gray	APFN 10 D1/2	07.313.1055.0 10

WKFN 16 SL/35

- Ground block with tension spring connection for mounting on TS 35
- Nominal cross section 16 mm²
- Ex e I/II  II 2GD IM2
Follow the EX installation instructions on page 160







Description	Type	Part No.	Std. Pack
Ground block	green/yellow	WKFN 16 SL/35	56.716.9055.0 50
GENERAL DATA			
Width / length / height, incl. TS 7.5	12 mm / 79 mm / 50 mm		
Wire strip length	16 mm		
Approvals	PTB   		PTB 06 ATEX 1075 U
TECHNICAL DATA			
	IEC	UL	CSA
			
	EN 60 947-7-2		
Cross section fine-stranded	0.2 – 16 mm ²		EN 60 079-0/-7
Cross section solid/stranded	1.5 – 25 mm ²		0.2 – 16 mm ²
Cross section, AWG	16 – 4		1.5 – 25 mm ²
Rated current	16 – 4		
Rated voltage	1000 V	600 V	600 V
Rated impulse voltage	8 kV		
Pollution degree	3		
ACCESSORIES			
	Type	Part No.	Std. Pack
End plate	gray	APFN 16	07.313.1255.0 10

WKFN 16 D1/2/SL/35

- Duo ground block with tension spring connection for mounting on TS 35
- Nominal cross section 16 mm²
- Ex e I/II  II 2GD IM2
Follow the EX installation instructions on page 160





Description	Type	Part No.	Std. Pack
Ground block	green/yellow	WKFN 16 D1/2/SL/35	56.716.9355.0 50
GENERAL DATA			
Width / length / height, incl. TS 7.5	12 mm / 107 mm / 50 mm		
Wire strip length	16 mm		
Approvals	PTB   		PTB 06 ATEX 1075 U
TECHNICAL DATA			
	IEC	CSA	
	EN 60 947-7-2		EN 60 079-0/-7
Cross section fine-stranded	0.2 – 16 mm ²		0.2 – 16 mm ²
Cross section solid/stranded	1.5 – 25 mm ²		1.5 – 25 mm ²
Cross section, AWG			16 – 4
Rated current			
Rated voltage	1000 V	600 V	
Rated impulse voltage	8 kV		
Pollution degree	3		
ACCESSORIES			
End plate	gray	APFN 16 D1/2	07.313.1455.0 10

WKF 35 SL/35

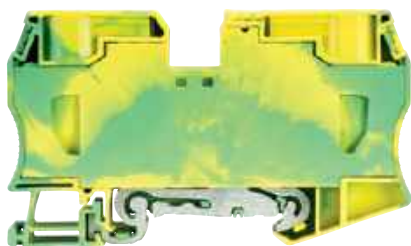
- Ground block with tension spring connection for mounting on TS 35
- Nominal cross section 35 mm²
- Ex e II  II 2GD
Follow the EX installation instructions on page 160



Description	Type	Part No.	Std. Pack
Ground block	green/yellow	WKF 35 SL/35	56.735.9053.0 10
GENERAL DATA			
Width / length / height, incl. TS 7.5	16 mm / 100 mm / 59 mm		
Wire strip length	25 mm		
Approvals	ATEX   		KEMA 03 ATEX 2057 U
TECHNICAL DATA			
	IEC	UL	CSA
	EN 60 947-7-1		EN 60 079-0/-7
Cross section fine-stranded	2.5 – 35 mm ²		2.5 – 35 mm ²
Cross section solid/stranded	2.5 – 35 mm ²		2.5 – 35 mm ²
Cross section, AWG		12 – 2	12 – 2
Rated current			
Rated voltage	800 V	600 V	600 V 690 V
Rated impulse voltage	8 kV		
Pollution degree	3		
ACCESSORIES			
Cross connector, insulated	2-pole	IVB WKF 35 – 2	Z7.285.6227.0 10
Cover with warning symbol over 4 blocks		ADF 35/5 GELB	04.343.9253.8 10
Test plug		ST 2/2,3	Z5.553.2921.0 10

ACCESSORIES FOR FASIS WKFN 10 SL AND WKFN 16 SL



ACCESSORIES	Type	Part No.	Std. Pack
Test plug	ST 2/2,3	Z5.553.2921.0	10
Screwdriver, uninsulated	DIN 5264 B 1x5,5	06.502.4200.0	5
for WKFN 10 ...			
Cross connector, insulated**	2-pole	IVB WKF 10 – 2	Z7.283.8227.0 10
Cover with warning symbol over 4 blocks	yellow	ADF 10/4 GELB	04.343.6453.8 10
for WKFN 16 ...			
Cross connector, insulated*	2-pole	IVB WKF 16 – 2	Z7.284.4227.0 10
Cover with warning symbol over 4 blocks	yellow	ADF 16/4 GELB	04.343.6653.8 10



** When cross connectors are used acc. to EN 60079-0 and EN 60079-7 the current must be reduced to 4 A/40 K or 5 A/45 K for type WKFN 10/35.

FASIS WKFN · MULTI-TIER TERMINAL BLOCKS WITH TENSION SPRING CONNECTION

WKF 1,5 E2/35

- Multi-tier block with tension spring connection for mounting on TS 35
- Nominal cross section 1.5 mm²
- Ex e II  II 2GD
Follow the EX installation instructions on page 160





Description	Type	Part No.	Std. Pack
Multi-tier block	gray WKF 1,5 E2/35	56.702.7653.0	50
GENERAL DATA			
Width / length / height, incl. TS 7.5	4 mm / 68 mm / 47 mm		
Wire strip length	10 mm		
Approvals	ATEX   KEMA 03 ATEX 2056 U		
TECHNICAL DATA			
	IEC	UL	CSA
			
Cross section fine-stranded	EN 60 947-7-1 EN 60 079-0/-7		
Cross section solid/stranded	0.08 – 1.5 mm ² 0.14 – 1.5 mm ²		
Cross section, AWG	26 – 14 26 – 14		
Rated current	17,5 A	15 A	15 A
Rated voltage	500 V	300 V	300 V
Rated impulse voltage	6 kV		440 V ²⁾
Pollution degree	3		
ACCESSORIES			
	Type	Part No.	Std. Pack
End plate	gray APF 1,5 E2	07.312.8753.0	10
Cross connector, insulated	2-pole	IVB WKF 1,5 – 2	10
	5-pole	IVB WKF 1,5 – 5	10
	10-pole	IVB WKF 1,5 – 10	10
Marking tag carrier, 2-fold	BT 4/2	04.243.0953.0	100

WKF 1,5 E2/VB/35

- Multi-tier block, vertically connected, with tension spring connection for mounting on TS 35
- Nominal cross section 1.5 mm²
- Ex e II  II 2GD
Follow the EX installation instructions on page 160





Description	Type	Part No.	Std. Pack
Multi-tier block	black WKF 1,5 E2/VB/35	56.702.6953.1	50
GENERAL DATA			
Width / length / height, incl. TS 7.5	4 mm / 68 mm / 47 mm		
Wire strip length	10 mm		
Approvals	ATEX   KEMA 03 ATEX 2056 U		
TECHNICAL DATA			
	IEC	UL	CSA
			
Cross section fine-stranded	EN 60 947-7-1 EN 60 079-0/-7		
Cross section solid/stranded	0.08 – 1.5 mm ² 0.14 – 1.5 mm ²		
Cross section, AWG	26 – 14 26 – 14		
Rated current	17,5 A	15 A	15 A
Rated voltage	500 V	300 V	300 V
Rated impulse voltage	6 kV		440 V ²⁾
Pollution degree	3		
ACCESSORIES			
	Type	Part No.	Std. Pack
End plate	gray APF 1,5 E2	07.312.8753.0	10
Cross connector, insulated	2-pole	IVB WKF 1,5 – 2	10
	5-pole	IVB WKF 1,5 – 5	10
	10-pole	IVB WKF 1,5 – 10	10
Marking tag carrier, 2-fold	BT 4/2	04.243.0953.0	100

WKF 1,5 E2/SL/35

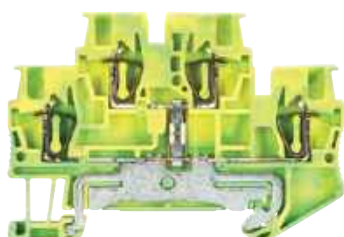
- Multi-tier ground block with tension spring connection for mounting on TS 35
- Nominal cross section 1.5 mm²
- Ex e II  II 2GD
Follow the EX installation instructions on page 160



Description	Type	Part No.	Std. Pack
Multi-tier ground block	green/yellow WKF 1,5 E2/SL/35	56.702.9253.0	50
GENERAL DATA			
Width / length / height, incl. TS 7.5	4 mm / 68 mm / 47 mm		
Wire strip length	10 mm		
Approvals	ATEX   KEMA 03 ATEX 2056 U		
TECHNICAL DATA			
	IEC	UL	CSA
			
Cross section fine-stranded	EN 60 947-7-2 EN 60 079-0/-7		
Cross section solid/stranded	0.08 – 1.5 mm ² 0.14 – 1.5 mm ²		
Cross section, AWG	26 – 14 26 – 14		
Rated current			
Rated voltage	500 V	300 V	300 V
Rated impulse voltage	6 kV		²⁾
Pollution degree	3		
ACCESSORIES			
	Type	Part No.	Std. Pack
End plate	gray APF 1,5 E2	07.312.8753.0	10
Marking tag carrier, 2-fold	BT 4/2	04.243.0953.0	100

¹⁾ Rated current when using cross connectors

²⁾ For maintaining the proper isolation distances, the open side of a feed-through terminal block as well as both sides of a jumper are to be covered by partitions.

FASIS WKFN · MULTI-TIER BLOCKS WITH TENSION SPRING CONNECTION

WKFN 2,5 E/35



WKFN 2,5 E/N/D/35

- Multi-tier block with tension spring connection for mounting on TS 35
- Nominal cross section 2.5 mm²
- Ex e I/II  II 2GD IM2
Follow the EX installation instructions on page 160



Description	Type	Part No.	Std. Pack
Multi-tier block	gray	WKFN 2,5 E/35	56.703.7055.0 100
Multi-tier block, combined	gray	WKFN 2,5 E/N/D/35	56.703.7655.0 100

GENERAL DATA

Width / length / height, incl. TS 7.5	5 mm / 82 mm / 48 mm		
Wire strip length	11 mm		
Approvals	PTB    USA-Ex CAN-Ex		PTB 04 ATEX 1051 U

TECHNICAL DATA

	IEC	UL	CSA	
	EN 60 947-7-1			EN 60 079-0/-7
Cross section fine-stranded	0.13 – 2.5 mm ²			0.2 – 2.5 mm ²
Cross section solid/stranded	0.13 – 4 mm ²			0.13 – 4 mm ²
Cross section, AWG		22 – 12	24 – 12	
Rated current	24 A	20 A	24 A	20/19 A ¹⁾
Rated voltage	500 V	300 V	300 V	440/275 V ²⁾
Rated impulse voltage	6 kV			
Pollution degree	3			

Note

- ¹⁾ solid/fine-stranded
²⁾ When using cross connectors on the upper tier

WKFN 2,5 E/N/D/35

	Function	Color ID
Upper tier	Feed-through	blue
Lower tier	Feed-through	gray

WKFN 2,5 E/VB/35

- Multi-tier block, vertically connected, with tension spring connection for mounting on TS 35
- Nominal cross section 2.5 mm²
- Ex e I/II  II 2GD IM2
Follow the EX installation instructions on page 160



Description	Type	Part No.	Std. Pack
Multi-tier block	black	WKFN 2,5 E/VB/35	56.703.6955.1 100

GENERAL DATA

Width / length / height, incl. TS 7.5	5 mm / 82 mm / 48 mm		
Wire strip length	11 mm		
Approvals	PTB    USA-Ex CAN-Ex		PTB 04 ATEX 1051 U

TECHNICAL DATA

	IEC	UL	CSA	
	EN 60 947-7-1			EN 60 079-0/-7
Cross section fine-stranded	0.13 – 2.5 mm ²			0.2 – 2.5 mm ²
Cross section solid/stranded	0.13 – 4 mm ²			0.13 – 4 mm ²
Cross section, AWG		22 – 12	24 – 12	
Rated current	24 A	20 A	24 A	20/19 A ¹⁾
Rated voltage	500 V	600 V	600 V	440 V
Rated impulse voltage	6 kV			
Pollution degree	3			

Note

- ¹⁾ solid/fine-stranded

WKFN 2,5 E/SL/35

- Ground block with tension spring connection for mounting on TS 35
- Nominal cross section 2.5 mm²
- Ex e I/II  II 2GD IM2
Follow the EX installation instructions on page 160

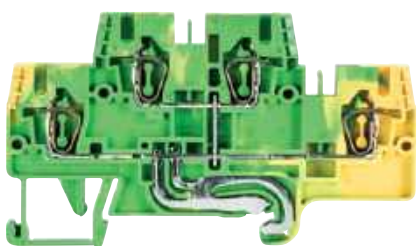

Description	Type	Part No.	Std. Pack
Ground block	green/yellow	WKFN 2,5 E/SL/35	56.703.8955.0 100

GENERAL DATA

Width / length / height, incl. TS 7.5	5 mm / 82 mm / 48 mm		
Wire strip length	11 mm		
Approvals	PTB    USA-Ex CAN-Ex		PTB 04 ATEX 1051 U

TECHNICAL DATA

	IEC	UL	CSA	
	EN 60 947-7-2			EN 60 079-0/-7
Cross section fine-stranded	0.13 – 2.5 mm ²			0.2 – 2.5 mm ²
Cross section solid/stranded	0.13 – 4 mm ²			0.13 – 4 mm ²
Cross section, AWG		22 – 12	24 – 12	
Rated current				
Rated voltage	500 V	600 V	600 V	
Rated impulse voltage	6 kV			
Pollution degree	3			

FASIS WKFN · MULTI-TIER BLOCKS WITH TENSION SPRING CONNECTION

WKFN 2,5 E-K

- Multi-tier block with tension spring connection for mounting on TS 35
- Nominal cross section 2.5 mm²



Description	Type	Part No.	Std. Pack
Multi-tier block	gray WKFN 2,5 E-K	56.703.4755.0	100
GENERAL DATA			
Width / length / height, incl. TS 7.5	5 mm / 68 mm / 48 mm		
Wire strip length	11 mm		
Approvals			
TECHNICAL DATA		IEC	
		EN 60 947-7-1	
Cross section fine-stranded	0.13 – 2.5 mm ²		
Cross section solid/stranded	0.13 – 4 mm ²		
Cross section, AWG			
Rated current	24 A		
Rated voltage	500 V		
Rated impulse voltage	6 kV		
Pollution degree	3		
ACCESSORIES			
End plate	gray APFN 2,5 E-K	07.313.5155.0	10

WKFN 2,5 EVB-K

- Multi-tier block, vertically connected, with tension spring connection for mounting on TS 35
- Nominal cross section 2.5 mm²



Description	Type	Part No.	Std. Pack
Multi-tier block	black WKFN 2,5 EVB-K	56.703.4855.1	100
GENERAL DATA			
Width / length / height, incl. TS 7.5	5 mm / 68 mm / 48 mm		
Wire strip length	11 mm		
Approvals			
TECHNICAL DATA		IEC	
		EN 60 947-7-1	
Cross section fine-stranded	0.13 – 2.5 mm ²		
Cross section solid/stranded	0.13 – 4 mm ²		
Cross section, AWG			
Rated current	24 A		
Rated voltage	500 V		
Rated impulse voltage	6 kV		
Pollution degree	3		
ACCESSORIES			
End plate	gray APFN 2,5 E-K	07.313.5155.0	10

WKFN 2,5 ESL-K

- Ground block with tension spring connection for mounting on TS 35
- Nominal cross section 2.5 mm²

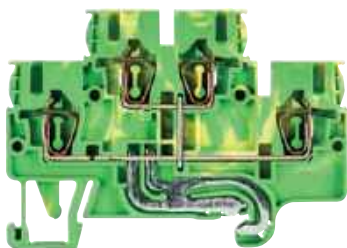

Description	Type	Part No.	Std. Pack
Ground block	green/yellow WKFN 2,5 ESL-K	56.703.4955.0	100
GENERAL DATA			
Width / length / height, incl. TS 7.5	5 mm / 68 mm / 42 mm		
Wire strip length	11 mm		
Approvals			
TECHNICAL DATA		IEC	
		EN 60 947-7-2	
Cross section fine-stranded	0.13 – 2.5 mm ²		
Cross section solid/stranded	0.13 – 4 mm ²		
Cross section, AWG			
Rated current			
Rated voltage	500 V		
Rated impulse voltage	6 kV		
Pollution degree	3		
ACCESSORIES			
End plate	gray APFN 2,5 E-K	07.313.5155.0	10

FASIS WKFN · MULTI-TIER BLOCKS WITH TENSION SPRING CONNECTION

WKFN 2,5 E/D/SL/35 WKFN 2,5 E/N/SL/35

- Multi-tier block, combined, with tension spring connection for mounting on TS 35
- Nominal cross section 2.5 mm²



Description	Type	Part No.	Std. Pack	
Multi-tier block, combined	gray WKFN 2,5 E/D/SL/35	56.703.7855.0	100	
Multi-tier block, combined	gray WKFN 2,5 E/N/SL/35	56.703.7755.0	100	
GENERAL DATA				
Width / length / height, incl. TS 7.5	5 mm / 82 mm / 48 mm			
Wire strip length	11 mm			
Approvals				
TECHNICAL DATA		IEC	UL	CSA
Cross section fine-stranded	0.13 – 2.5 mm ²			
Cross section solid/stranded	0.13 – 4 mm ²			
Cross section, AWG	22 – 12			
Rated current	24 A	20 A	24 A	
Rated voltage	500 V	300 V	300 V	
Rated impulse voltage	6 kV			
Pollution degree	3			

WKFN 2,5 E/D/SL/35

	Function	Color ID
Upper tier	Feed-through	gray
Lower tier	Ground conductor	green/yellow

WKFN 2,5 E/N/SL/35

	Function	Color ID
Upper tier	Feed-through	blue
Lower tier	Ground conductor	green/yellow

WKFN 2,5 E...G

- Multi-tier function block with tension spring connection for mounting on TS 35
- Nominal cross section 2.5 mm²

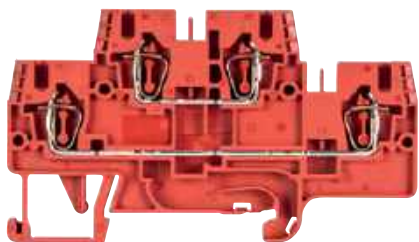

Description	Type	Part No.	Std. Pack	
Multi-tier function block	red WKFN 2,5 E.../35	56.703.XX55.5	100	
Multi-tier function block	orange WKFN 2,5 E.../35	56.703.XX55.9	100	
GENERAL DATA				
Width / length / height, incl. TS 7.5	5 mm / 82 mm / 48 mm			
Wire strip length	11 mm			
Approvals				
TECHNICAL DATA		IEC	UL	CSA
Cross section fine-stranded	0.13 – 2.5 mm ²			
Cross section solid/stranded	0.13 – 4 mm ²			
Cross section, AWG	22 – 12			

FUNCTION DIAGRAM FOR FASIS WKFN 2,5 E...

The multi-tier block is available on request as a function block for a wide variety of switching tasks.

56.703.7555.9 56.703.7555.5		56.703.8255.5		I = 1 A U = 1000 V	56.703.7455.9		R = 4.7 kΩ P = 0.5 W LED red U = 24 V DC
56.703.7155.5 56.703.7155.9		56.703.7955.5		I = 1 A U = 1000 V	56.703.7255.5		R = 4.7 kΩ P = 0.5 W LED red U = 24 V DC
56.703.8155.9		56.703.8355.5		I = 1 A U = 1000 V	56.703.7355.5		R = 680 kΩ P = 0.25 W U = 100-500 V

ACCESSORIES FOR FASIS WKFN 2,5 E



ACCESSORIES	Type	Part No.	Std. Pack
End plate	gray APFN 2,5 E	07.312.7355.0	10
Partition	gray WFN 2,5 E	07.312.7455.0	10
Cross connector, insulated	2-pole	IVB WKF 2,5 – 2	27.280.6227.0
	3-pole	IVB WKF 2,5 – 3	27.280.6327.0
	4-pole	IVB WKF 2,5 – 4	27.280.6427.0
	5-pole	IVB WKF 2,5 – 5	27.280.6527.0
	10-pole	IVB WKF 2,5 – 10	27.280.7027.0
	20-pole	IVB WKF 2,5 – 20	27.280.8027.0
Vertical cross connector	1-pole	IVB WKF-V	27.261.1127.0
Wire entry guide	0.13 – 0.2 mm ²	LELN 2,5/1 WEISS	05.564.3755.0
	0.25 – 0.5 mm ²	LELN 2,5/2 GRAU	05.564.3855.0
	0.75 – 1.0 mm ²	LELN 2,5/3 SCHWARZ	05.564.3955.0
Cover with warning symbol over 4 blocks	yellow	ADFN 2,5/4 GELB	04.343.8353.8
Marking tag carrier, 3-fold		BT 5/3	04.243.0755.0

Technical information see FACTS & DATA page 158 ff.

Subject to technical modifications

FASIS WKFN · DUO MULTI-TIER TERMINAL BLOCKS WITH TENSION SPRING CONNECTION

WKFN 2,5 E1/2/35

WKFN 2,5 E1/2/N/D/35

- Duo multi-tier block with tension spring connection for mounting on TS 35
- Nominal cross section 2.5 mm²
- Ex e I/II  II 2GD IM2
Follow the EX installation instructions on page 160



Description	Type	Part No.	Std. Pack
Multi-tier block	gray	WKFN 2,5 E1/2/35	56.703.6055.0
Multi-tier block, combined	gray	WKFN 2,5 E1/2/N/D/35	56.703.6355.0

GENERAL DATA

Width / length / height, incl. TS 7.5	5 mm / 107 mm / 48 mm		
Wire strip length	11 mm		
Approvals	PTB    USA-Ex CAN-Ex		PTB 04 ATEX 1051 U

TECHNICAL DATA

	IEC	UL	CSA	
	EN 60 947-7-1			EN 60 079-0/-7
Cross section fine-stranded	0.13–2.5 mm ²			0.2–2.5 mm ²
Cross section solid/stranded	0.13–4 mm ²			0.13–4 mm ²
Cross section, AWG		22–12	24–12	
Rated current	22 A	20 A	24 A	20/17,5 A ¹⁾
Rated voltage	500 V	300 V	300 V	440/275 V ²⁾
Rated impulse voltage	6 kV			
Pollution degree	3			

Note

- ¹⁾ solid/fine-stranded
²⁾ When using cross connectors on the upper tier



WKFN 2,5 E1/2/VB/35

- Duo multi-tier block, vertically connected, with tension spring connection for mounting on TS 35
- Nominal cross section 2.5 mm²
- Ex e I/II  II 2GD IM2
Follow the EX installation instructions on page 160



Description	Type	Part No.	Std. Pack
Multi-tier block	black	WKFN 2,5 E1/2/VB/35	56.703.5955.1

GENERAL DATA

Width / length / height, incl. TS 7.5	5 mm / 107 mm / 48 mm		
Wire strip length	11 mm		
Approvals	PTB    USA-Ex CAN-Ex		PTB 04 ATEX 1051 U

TECHNICAL DATA

	IEC	UL	CSA	
	EN 60 947-7-1			EN 60 079-0/-7
Cross section fine-stranded	0.13–2.5 mm ²			0.2–2.5 mm ²
Cross section solid/stranded	0.13–4 mm ²			0.13–4 mm ²
Cross section, AWG		22–12	24–12	
Rated current	22 A	20 A	24 A	20/17,5 A ¹⁾
Rated voltage	500 V	300 V	300 V	440 V
Rated impulse voltage	6 kV			
Pollution degree	3			

Note

- ¹⁾ solid/fine-stranded

ACCESSORIES

Description	Type	Part No.	Std. Pack
Partition	gray	TWFN 2,5 E1/2	07.312.7855.0

WKFN 2,5 E1/2/SL/35

- Duo multi-tier ground block with tension spring connection for mounting on TS 35
- Nominal cross section 2.5 mm²
- Ex e I/II  II 2GD IM2
Follow the EX installation instructions on page 160

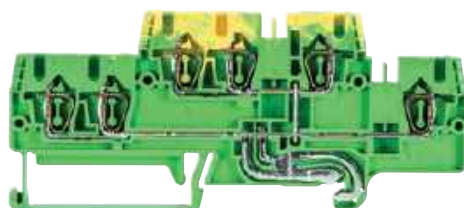

Description	Type	Part No.	Std. Pack
Ground block	green/yellow	WKFN 2,5 E1/2/SL/35	56.703.6255.0

GENERAL DATA

Width / length / height, incl. TS 7.5	5 mm / 107 mm / 48 mm		
Wire strip length	11 mm		
Approvals	PTB    USA-Ex CAN-Ex		PTB 04 ATEX 1051 U

TECHNICAL DATA

	IEC	UL	CSA	
	EN 60 947-7-2			EN 60 079-0/-7
Cross section fine-stranded	0.13–2.5 mm ²			0.2–2.5 mm ²
Cross section solid/stranded	0.13–4 mm ²			0.13–4 mm ²
Cross section, AWG		22–12	24–12	
Rated current				
Rated voltage	500 V	600 V	600 V	
Rated impulse voltage	6 kV			
Pollution degree	3			

FASIS WKFN · DUO MULTI-TIER TERMINAL BLOCKS WITH TENSION SPRING CONNECTION

WKFN 2,5 E1/2/D/SL/35 WKFN 2,5 E1/2/N/SL/35

- Duo multi-tier block, combined, with tension spring connection for mounting on TS 35
- Nominal cross section 2.5 mm²



Description	Type	Part No.	Std. Pack
Multi-tier block, combined	gray WKFN 2,5 E1/2/D/SL/35	56.703.6155.0	50
Multi-tier block, combined	gray WKFN 2,5 E1/2/N/SL/35	56.703.6455.0	50

GENERAL DATA			
Width / length / height, incl. TS 7.5	5 mm / 107 mm / 48 mm		
Wire strip length	11 mm		
Approvals			

TECHNICAL DATA		IEC	UL	CSA
		EN 60 947-7-1		
Cross section fine-stranded	0.13 – 2.5 mm ²			
Cross section solid/stranded	0.13 – 4 mm ²			
Cross section, AWG			22 – 12	24 – 12
Rated current	22 A		20 A	24 A
Rated voltage	500 V		300 V	300 V
Rated impulse voltage	6 kV			
Pollution degree	3			

COLOR CODE

WKFN 2,5 E1/2/35 Block color: gray

	Function	Color ID
Upper tier	Feed-through	gray
Lower tier	Feed-through	gray

WKFN 2,5 E1/2/D/SL/35 Block color: gray

	Function	Color ID
Upper tier	Feed-through	gray
Lower tier	Ground conductor	green/yellow

WKFN 2,5 E1/2/N/D/35 Block color: gray

	Function	Color ID
Upper tier	Feed-through	blue
Lower tier	Feed-through	gray

WKFN 2,5 E1/2/N/SL/35 Block color: gray

	Function	Color ID
Upper tier	Feed-through	blue
Lower tier	Ground conductor	green/yellow

WKFN 2,5 E1/2/VB/35 Block color: black

	Function	Color ID
Upper tier	Feed-through	black
Lower tier	vert. jumpered	black

WKFN 2,5 E1/2/SL/35 Block color: green/yellow

	Function	Color ID
Upper tier	Ground conductor	green/yellow
Lower tier	vert. jumpered	green/yellow

ACCESSORIES FOR FASIS WKFN 2,5 E1/2

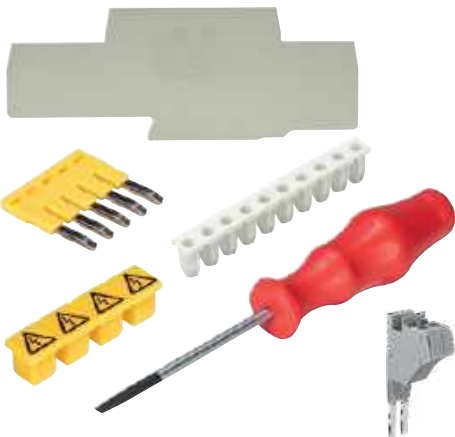

ACCESSORIES	Type	Part No.	Std. Pack
End plate	gray APFN 2,5 E1/2	07.312.7755.0	10
Partition	gray TWFN 2,5 E1/2	07.312.7855.0	10
Cross connector, insulated	2-pole IVB WKF 2,5 – 2	Z7.280.6227.0	10
	3-pole IVB WKF 2,5 – 3	Z7.280.6327.0	10
	4-pole IVB WKF 2,5 – 4	Z7.280.6427.0	10
	5-pole IVB WKF 2,5 – 5	Z7.280.6527.0	10
	10-pole IVB WKF 2,5 – 10	Z7.280.7027.0	20
	20-pole IVB WKF 2,5 – 20	Z7.280.8027.0	20
Vertical cross connector	1-pole IVB WKF-V	Z7.261.1127.0	10
Wire entry guide	0.13 – 0.2 mm ² LELN 2,5/1 WEISS	05.564.3755.0	100
	0.25 – 0.5 mm ² LELN 2,5/2 GRAU	05.564.3855.0	100
	0.75 – 1.0 mm ² LELN 2,5/3 SCHWARZ	05.564.3955.0	100
Cover with warning symbol over 4 blocks	yellow ADFN 2,5/4 GELB	04.343.8353.8	10
Marking tag carrier, 2-fold	BT 5/2	04.243.0855.0	100
Test adapter, modular	PS WKC/F	Z1.299.9753.0	10
Test plug	ST 2/2,3	Z5.553.2921.0	10
Screwdriver, uninsulated	DIN 5264 B 0,6x3,5	06.502.4000.0	5
Screwdriver, uninsulated, MINI	DIN 5264 B 0,6x3,5 M	06.502.5000.0	10

Technical information see FACTS & DATA page 158 ff.

Subject to technical modifications

FASIS WKFN · MULTI-TIER TERMINAL BLOCKS WITH TENSION SPRING CONNECTION



WKFN 2,5 E3/35

- Multi-tier block with tension spring connection for mounting on TS 35
- Nominal cross section 2.5 mm²
- Ex e I/II  II 2GD IM2
Follow the EX installation instructions on page 160



Description	Type	Part No.	Std. Pack
Multi-tier block	gray WKFN 2,5 E3/35	56.703.3055.0	50

GENERAL DATA

Width / length / height, incl. TS 7.5	5 mm / 123 mm / 59 mm		
Wire strip length	11 mm		
Approvals	PTB    USA-Ex CAN-Ex		PTB 04 ATEX 1051 U

TECHNICAL DATA

	IEC	UL	CSA	
	EN 60 947-7-1			
Cross section fine-stranded	0.13 – 2.5 mm ²			EN 60 079-0/-7
Cross section solid/stranded	0.13 – 4 mm ²			0.2 – 2.5 mm ²
Cross section, AWG	22 – 12		24 – 12	0.13 – 4 mm ²
Rated current	20 A	20 A	24 A	19/17,5 A ¹⁾
Rated voltage	500 V	300 V	300 V	440/275 V ²⁾
Rated impulse voltage	6 kV			
Pollution degree	3			

Note

- ¹⁾ solid/fine-stranded
²⁾ When using cross connectors on the upper tier



WKFN 2,5 E3/VB/35

- Multi-tier block, vertically connected, with tension spring connection for mounting on TS 35
- Nominal cross section 2.5 mm²
- Ex e I/II  II 2GD IM2
Follow the EX installation instructions on page 160



Description	Type	Part No.	Std. Pack
Multi-tier block	black WKFN 2,5 E3/VB/35	56.703.2955.1	50

GENERAL DATA

Width / length / height, incl. TS 7.5	5 mm / 123 mm / 59 mm		
Wire strip length	11 mm		
Approvals	PTB    USA-Ex CAN-Ex		PTB 04 ATEX 1051 U

TECHNICAL DATA

	IEC	UL	CSA	
	EN 60 947-7-1			
Cross section fine-stranded	0.13 – 2.5 mm ²			EN 60 079-0/-7
Cross section solid/stranded	0.13 – 4 mm ²			0.2 – 2.5 mm ²
Cross section, AWG	22 – 12		24 – 12	0.13 – 4 mm ²
Rated current	20 A	20 A	24 A	20/19 A ¹⁾
Rated voltage	500 V	600 V	600 V	440 V
Rated impulse voltage	6 kV			
Pollution degree	3			

Note

- ¹⁾ solid/fine-stranded

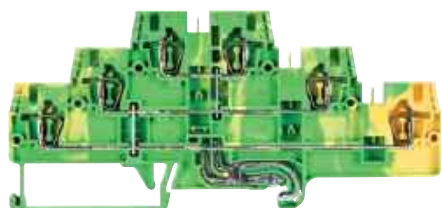

WKFN 2,5 E3/SL/35

- Multi-tier ground block with tension spring connection for mounting on TS 35
- Nominal cross section 2,5 mm²
- Ex e I/II  II 2GD IM2
Follow the EX installation instructions on page 160



Description	Type	Part No.	Std. Pack
Multi-tier ground block	green/yellow WKFN 2,5 E/SL/35	56.703.8855.0	50

GENERAL DATA

Width / length / height, incl. TS 7.5	5 mm / 123 mm / 59 mm		
Wire strip length	11 mm		
Approvals	PTB    USA-Ex CAN-Ex		PTB 04 ATEX 1051 U

TECHNICAL DATA

	IEC	UL	CSA	
	EN 60 947-7-2			
Cross section fine-stranded	0.13 – 2.5 mm ²			EN 60 079-0/-7
Cross section solid/stranded	0.13 – 4 mm ²			0.2 – 2.5 mm ²
Cross section, AWG	22 – 12		24 – 12	0.13 – 4 mm ²
Rated current				
Rated voltage	500 V	600 V	600 V	
Rated impulse voltage	6 kV			
Pollution degree	3			

FASIS WKFN · MULTI-TIER / MOTOR CONNECTION BLOCK WITH TENSION SPRING CONNECTION

WKFN 2,5 E3/D/D/SL/35 WKFN 2,5 E3/N/D/SL/35

- Multi-tier block, combined, with tension spring connection for mounting on TS 35
- Nominal cross section 2.5 mm²



Description	Type	Part No.	Std. Pack
Multi-tier block	gray WKFN 2,5 E3/D/D/SL/35	56.703.3355.0	50
Multi-tier block	gray WKFN 2,5 E3/N/D/SL/35	56.703.3255.0	50

GENERAL DATA

Width / length / height, incl. TS 7.5	5 mm / 123 mm / 59 mm
Wire strip length	11 mm
Approvals	UL, CE, RoHS

TECHNICAL DATA

	IEC	UL	CSA
Cross section fine-stranded	EN 60 947-7-1		
Cross section solid/stranded	0.13 – 2.5 mm ²		
Cross section, AWG		22 – 12	24 – 12
Rated current	20 A	20 A	24 A
Rated voltage	500 V	300 V	300 V
Rated impulse voltage	6 kV		
Pollution degree	3		

WKFN 2,5 E3/N/D/SL/35

Block color: gray

	Function	Color ID
Upper tier	Feed-through	blue
Center tier	Feed-through	gray
Lower tier	Ground conductor	green/yellow

WKFN 2,5 E3/D/D/SL/35

Block color: gray

	Function	Color ID
Upper tier	Feed-through	gray
Center tier	Feed-through	gray
Lower tier	Ground conductor	green/yellow

WKF 4 3D/SL

- Motor connection block with tension spring connection for mounting on TS 35
- Nominal cross section 4 mm²



Description	Type	Part No.	Std. Pack
Motor connection block	gray WKF 4 3D/SL	56.704.8453.0	50

GENERAL DATA

Width / length / height, incl. TS 7.5	6 mm / 100 mm / 84 mm
Wire strip length	10 mm
Approvals	UL, CE, RoHS

TECHNICAL DATA

	IEC	UL	CSA
Cross section fine-stranded	EN 60947-7-1/DIN VDE 0611 T1		
Cross section solid/stranded	0.13 – 4 mm ²		
Cross section, AWG		28 – 10	28 – 10
Rated current	28 A	30 A	30 A
Rated voltage	800 V	600 V	600 V
Rated impulse voltage	8 kV		
Pollution degree	3		

ACCESSORIES FOR FASIS WKFN 2,5 E3



ACCESSORIES	Type	Part No.	Std. Pack
End plate	gray APFN 2,5 E3	07.312.7555.0	10
Partition	gray TWFN 2,5 E3	07.312.7655.0	10
Cross connector, insulated	2-pole	IVB WKFN 2,5 – 2	27.280.6227.0
	3-pole	IVB WKFN 2,5 – 3	27.280.6327.0
	4-pole	IVB WKFN 2,5 – 4	27.280.6427.0
	5-pole	IVB WKFN 2,5 – 5	27.280.6527.0
	10-pole	IVB WKFN 2,5 – 10	27.280.7027.0
	20-pole	IVB WKFN 2,5 – 20	27.280.8027.0
Vertical cross connector	1-pole	IVB WKFN-V	27.261.1127.0
Wire entry guide	0.13 – 0.2 mm ²	LELN 2,5/1 WEISS	05.564.3755.0
	0.25 – 0.5 mm ²	LELN 2,5/2 GRAU	05.564.3855.0
	0.75 – 1.0 mm ²	LELN 2,5/3 SCHWARZ	05.564.3955.0
Cover with warning symbol over 4 blocks	yellow	ADFN 2,5/4 GELB	04.343.8353.8
Marking tag carrier, 2-fold		BT 5/2	04.243.0855.0

Technical information see FACTS & DATA page 158 ff.

Subject to technical modifications

FASIS WKFN · MULTI-TIER TERMINAL BLOCKS WITH TENSION SPRING CONNECTION





WKFN 4 E/35

WKFN 4 E/N/D/35

- Multi-tier block with tension spring connection for mounting on TS 35
- Nominal cross section 4 mm²
- Ex e I/II  II 2GD IM2
Follow the EX installation instructions on page 160



Description	Type	Part No.	Std. Pack
Multi-tier block	gray WKFN 4 E/35	56.704.7055.0	100
Multi-tier block, combined	gray WKFN 4 E/N/D/35	56.704.7655.0	100

GENERAL DATA				
Width / length / height, incl. TS 7.5	6 mm / 90 mm / 48 mm			
Wire strip length	11 mm			
Approvals	PTB    CAN-Ex			PTB 05 ATEX 1104 U
TECHNICAL DATA				
	IEC	UL	CSA	
	EN 60 947-7-1			
Cross section fine-stranded	0.13 – 4 mm ²			EN 60 079-0/-7
Cross section solid/stranded	0.13 – 6 mm ²			0.13 – 4 mm ²
Cross section, AWG	24 – 10			24 – 10
Rated current	32 A	30 A	32 A	27 A
Rated voltage	500 V	300 V	300 V	440/352 V ¹⁾
Rated impulse voltage	6 kV			
Pollution degree	3			

Note ¹⁾ When using cross connectors on the upper tier

WKFN 4 E/N/D/35 Block color: gray





	Function	Color ID
Upper tier	Feed-through	blue
Lower tier	Feed-through	gray

WKFN 4 E/VB/35

- Multi-tier block, vertically connected, with tension spring connection for mounting on TS 35
- Nominal cross section 4 mm²
- Ex e I/II  II 2GD IM2
Follow the EX installation instructions on page 160



Description	Type	Part No.	Std. Pack
Multi-tier block	black WKFN 4 E/VB/35	56.704.6955.1	100





GENERAL DATA				
Width / length / height, incl. TS 7.5	6 mm / 90 mm / 48 mm			
Wire strip length	11 mm			
Approvals	PTB    CAN-Ex			PTB 05 ATEX 1104 U
TECHNICAL DATA				
	IEC	UL	CSA	
	EN 60 947-7-1			
Cross section fine-stranded	0.13 – 4 mm ²			EN 60 079-0/-7
Cross section solid/stranded	0.13 – 6 mm ²			0.13 – 4 mm ²
Cross section, AWG	24 – 10			24 – 10
Rated current	32 A	30 A	32 A	30 A
Rated voltage	500 V	600 V	300 V	440 V
Rated impulse voltage	6 kV			
Pollution degree	3			

WKFN 4 E/SL/35

- Multi-tier ground block with tension spring connection for mounting on TS 35
- Nominal cross section 4 mm²
- Ex e I/II  II 2GD IM2
Follow the EX installation instructions on page 160



Description	Type	Part No.	Std. Pack
Multi-tier ground block	green/yellow WKFN 4 E SL/35	56.704.9255.0	100

GENERAL DATA				
Width / length / height, incl. TS 7.5	6 mm / 90 mm / 48 mm			
Wire strip length	11 mm			
Approvals	PTB    CAN-Ex			PTB 05 ATEX 1104 U
TECHNICAL DATA				
	IEC	UL	CSA	
	EN 60 947-7-2			
Cross section fine-stranded	0.13 – 4 mm ²			EN 60 079-0/-7
Cross section solid/stranded	0.13 – 6 mm ²			0.13 – 4 mm ²
Cross section, AWG	24 – 10			24 – 10
Rated current				
Rated voltage	500 V	600 V	600 V	
Rated impulse voltage	6 kV			
Pollution degree	3			

ACCESSORIES FOR FASIS WKFN 4

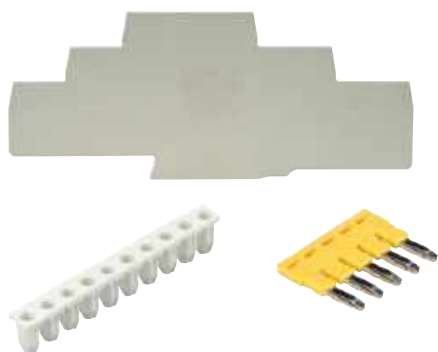

ACCESSORIES	Type	Part No.	Std. Pack
End plate	gray APFN 4 E...	07.312.9655.0	10
Partition	gray TWFN 4 E...	07.312.9755.0	10
Cross connector, insulated	2-pole IVB WKF 4-2	Z7.261.1227.0	10
	3-pole IVB WKF 4-3	Z7.261.1327.0	10
	4-pole IVB WKF 4-4	Z7.261.1427.0	10
	5-pole IVB WKF 4-5	Z7.261.1527.0	10
	6-pole IVB WKF 4-6	Z7.261.1627.0	10
	7-pole IVB WKF 4-7	Z7.261.1727.0	20
	8-pole IVB WKF 4-8	Z7.261.1827.0	20
	9-pole IVB WKF 4-9	Z7.261.1927.0	20
	10-pole IVB WKF 4-10	Z7.261.2027.0	20
	Vertical cross connector, insulated	1-pole IVB WKF-V	Z7.261.1127.0
Wire entry guide	0.13 - 0.2 mm ² LEL 4/1 WEISS	05.561.8553.0	100
	0.25 - 0.5 mm ² LEL 4/2 GRAU	05.561.8653.0	100
	0.75 - 1.0 mm ² LEL 4/3 SCHWARZ	05.561.8753.0	100

Technical information see FACTS & DATA page 158 ff.

Subject to technical modifications

FASIS WKFN · KNIFE DISCONNECT TERMINAL BLOCKS WITH TENSION SPRING CONNECTION

WKFN 2,5 TKM/35

- Knife disconnect terminal block with tension spring connection for mounting on TS 35
- Nominal cross section 2.5 mm²



Description	Type	Part No.	Std. Pack
Disconnect terminal block	gray WKFN 2,5 TKM/35	56.703.5355.0	100
GENERAL DATA			
Width / length / height, incl. TS 7.5	5 mm / 60 mm / 38 mm		
Wire strip length	11 mm		
Approvals			
TECHNICAL DATA	IEC	UL	CSA
	EN 60947-7-1		
Cross section fine-stranded	0.14 – 2.5 mm ²		
Cross section solid/stranded	0.2 – 4 mm ²		
Cross section, AWG	24 – 12	24 – 12	
Rated current	20 A	19 A	20 A
Rated voltage	630 V	300 V	300 V
Rated impulse voltage	6 kV		
Pollution degree	3		
ACCESSORIES	Type	Part No.	Std. Pack
End plate	gray APFN 2,5 D1/2	07.312.6955.0	10
Partition	gray TWFN 2,5 D1/2	07.312.7055.0	10

WKFN 2,5 TKM 1/2/35

- Duo knife disconnect terminal block with tension spring connection for mounting on TS 35
- Nominal cross section 2.5 mm²



Description	Type	Part No.	Std. Pack
Disconnect terminal block	gray WKFN 2,5 TKM 1/2/35	56.703.5455.0	100
GENERAL DATA			
Width / length / height, incl. TS 7.5	5 mm / 72 mm / 38 mm		
Wire strip length	11 mm		
Approvals			
TECHNICAL DATA	IEC	UL	CSA
	EN 60947-7-1		
Cross section fine-stranded	0.14 – 2.5 mm ²		
Cross section solid/stranded	0.2 – 4 mm ²		
Cross section, AWG	24 – 12	24 – 12	
Rated current	20 A	19 A	20 A
Rated voltage	630 V	300 V	300 V
Rated impulse voltage	6 kV		
Pollution degree	3		
ACCESSORIES	Type	Part No.	Std. Pack
End plate	gray APFN 2,5 D2/2	07.312.7155.0	10
Partition	gray TWFN 2,5 D2/2	07.312.7255.0	10

WKFN 2,5 TKM 2/2/35

- Duo knife disconnect terminal block with tension spring connection for mounting on TS 35
- Nominal cross section 2.5 mm²



Description	Type	Part No.	Std. Pack
Disconnect terminal block	gray WKFN 2,5 TKM 2/2/35	56.703.5555.0	100
GENERAL DATA			
Width / length / height, incl. TS 7.5	5 mm / 85 mm / 38 mm		
Wire strip length	11 mm		
Approvals			
TECHNICAL DATA	IEC	UL	CSA
	EN 60947-7-1		
Cross section fine-stranded	0.14 – 2.5 mm ²		
Cross section solid/stranded	0.2 – 4 mm ²		
Cross section, AWG	24 – 12	24 – 12	
Rated current	20 A	19 A	20 A
Rated voltage	630 V	300 V	300 V
Rated impulse voltage	6 kV		
Pollution degree	3		
ACCESSORIES	Type	Part No.	Std. Pack
End plate	gray APFN 2,5 TKM D2/2	07.313.0055.0	10
Partition	gray TWFN 2,5 TKM D2/2	07.313.0155.0	10

FASIS WKFN · MULTI-TIER DISCONNECT TERMINAL BLOCKS WITH TENSION SPRING CONNECTION

WKFN 2,5 TKM E1/35

- Multi-tier disconnect terminal block with tension spring connection for mounting on TS 35
- Nominal cross section 2.5 mm²



Description	Type	Part No.	Std. Pack
Disconnect terminal block	gray	WKFN 2,5 TKM E1/35	56.703.6555.0 50
GENERAL DATA			
Width / length / height, incl. TS 7.5	5 mm / 107 mm / 48 mm		
Wire strip length	11 mm		
Approvals			
TECHNICAL DATA		IEC	UL CSA
		EN 60947-7-1	
Cross section fine-stranded	0.14 – 2.5 mm ²		
Cross section solid/stranded	0.2 – 4 mm ²		
Cross section, AWG		24 – 12	24 – 12
Rated current	20 A	19 A	20 A
Rated voltage	500 V	300 V	300 V
Rated impulse voltage	6 kV		
Pollution degree	3		
ACCESSORIES		Type	Part No. Std. Pack
End plate	gray	APFN 2,5 E1/2	07.312.7755.0 10
Partition	gray	TWFN 2,5 E1/2	07.312.7855.0 10

WKFN 2,5 TKM E2/35

- Multi-tier disconnect terminal block with tension spring connection for mounting on TS 35
- Nominal cross section 2.5 mm²



Description	Type	Part No.	Std. Pack
Disconnect terminal block	gray	WKFN 2,5 TKM E2/35	56.703.6655.0 50
GENERAL DATA			
Width / length / height, incl. TS 7.5	5 mm / 107 mm / 48 mm		
Wire strip length	11 mm		
Approvals			
TECHNICAL DATA		IEC	UL CSA
		EN 60947-7-1	
Cross section fine-stranded	0.14 – 2.5 mm ²		
Cross section solid/stranded	0.2 – 4 mm ²		
Cross section, AWG		24 – 12	24 – 12
Rated current	19 A	19 A	19 A
Rated voltage	500 V	300 V	300 V
Rated impulse voltage	6 kV		
Pollution degree	3		
Accessories		Type	Part No. Std. Pack
End plate	gray	APFN 2,5 E1/2	07.312.7755.0 10
Partition	gray	TWFN 2,5 E1/2	07.312.7855.0 10

ACCESSORIES FOR FASIS WKFN 2,5 TKM

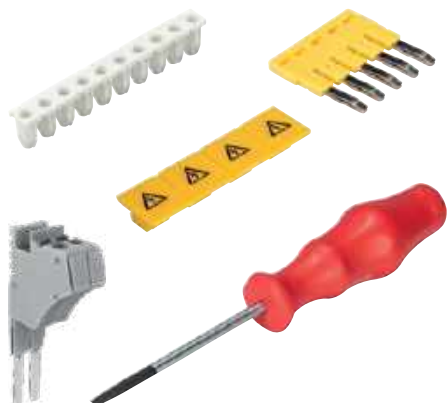

ACCESSORIES	Type	Part No.	Std. Pack
Cross connector, insulated	2-pole	IVB WKFN 2,5 – 2	Z7.280.6227.0 10
	3-pole	IVB WKFN 2,5 – 3	Z7.280.6327.0 10
	4-pole	IVB WKFN 2,5 – 4	Z7.280.6427.0 10
	5-pole	IVB WKFN 2,5 – 5	Z7.280.6527.0 10
	6-pole	IVB WKFN 2,5 – 6	Z7.280.6627.0 10
	7-pole	IVB WKFN 2,5 – 7	Z7.280.6727.0 20
	8-pole	IVB WKFN 2,5 – 8	Z7.280.6827.0 20
	9-pole	IVB WKFN 2,5 – 9	Z7.280.6927.0 20
	10-pole	IVB WKFN 2,5 – 10	Z7.280.7027.0 20
	20-pole	IVB WKFN 2,5 – 20	Z7.280.8027.0 20
Wire entry guide	0.13 – 0.2 mm ²	LELN 2,5/1 WEISS	05.564.3755.0 100
	0.25 – 0.5 mm ²	LELN 2,5/2 GRAU	05.564.3855.0 100
	0.75 – 1.0 mm ²	LELN 2,5/3 SCHWARZ	05.564.3955.0 100
Cover with warning symbol over 4 blocks	yellow	ADFN 2,5/4 GELB	04.343.8353.8 10
Test adapter, modular		PS WKCF	Z1.299.9753.0 10
Test plug		ST 2/2,3	Z5.553.2921.0 10
Screwdriver, uninsulated		DIN 5264 B 0,6x3,5	06.502.4000.0 5
Screwdriver, uninsulated, MINI		DIN 5264 B 0,6x3,5 M	06.502.5000.0 10

Technical information see FACTS & DATA page 158 ff.

Subject to technical modifications

FASIS WKFN · FUSE BLOCKS WITH TENSION SPRING CONNECTION

WKFN 4 TKG WITH THSI 5 X 20

- Disconnect block with tension spring connection for mounting on TS 35
- Nominal cross section 4 mm²

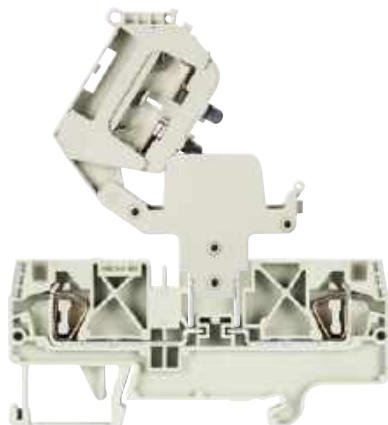

Description	Type	Part No.	Std. Pack
Disconnect block	gray WKFN 4 TKG/35	56.704.4055.0	100
Fuse disconnect lever	THSI 5x20	Z1.298.1053.0	10
Fuse disconnect lever with LED 12–24 V ²⁾	THSI 5x20 LED24	Z1.298.1153.0	10
Fuse disconnect lever with LED 24–60 V ²⁾	THSI 5x20 LED60	Z1.298.1253.0	10
Fuse disconnect lever with GL 110–250 V ²⁾	THSI 5x20 GL250	Z1.298.1353.0	10

GENERAL DATA

Width / length / height, incl. TS 7.5	6 mm / 82 mm / 38 mm
Wire strip length	11 mm
Approvals	

TECHNICAL DATA

	IEC	UL	CSA
	EN 60 947-7-3		
Cross section fine-stranded	0.13 – 4 mm ²		
Cross section solid/stranded	0.13 – 6 mm ²		
Cross section, AWG		24 – 10	22 – 10
Rated current	¹⁾	¹⁾	10 A ¹⁾
Rated voltage	500 V ²⁾	600 V ²⁾	300 V ²⁾
Rated impulse voltage	8 kV		
Pollution degree	3		

ACCESSORIES

Description	Type	Part No.	Std. Pack
End plate	gray APFN 4 D2/2	07.312.9055.0	10
Partition	gray TWFN 4 D2/2	07.312.9155.0	10

WKFN 4 TKG WITH THSI 6,3 X 32

- Disconnect block with tension spring connection for mounting on TS 35
- Nominal cross section 4 mm²



Description	Type	Part No.	Std. Pack
Disconnect block	gray WKFN 4 TKG/35	56.704.4055.0	100
Fuse disconnect lever	THSI 6,3x32	Z1.298.1653.0	10
Fuse disconnect lever with LED 12–24 V ²⁾	THSI 6,3x32 LED24	Z1.298.1753.0	10
Fuse disconnect lever with LED 24–60 V ²⁾	THSI 6,3x32 LED60	Z1.298.1853.0	10
Fuse disconnect lever with GL 110–250 V ²⁾	THSI 6,3x32 GL250	Z1.298.1953.0	10
Fuse disconnect lever with GL 500 V ²⁾	THSI 6,3x32 GL500	Z1.298.2053.0	10

GENERAL DATA

Width / length / height, incl. TS 7.5	6 mm / 82 mm / 38 mm
Wire strip length	11 mm
Approvals	

TECHNICAL DATA

	IEC	UL	CSA
	EN 60 947-7-3		
Cross section fine-stranded	0.13 – 4 mm ²		
Cross section solid/stranded	0.13 – 6 mm ²		
Cross section, AWG		24 – 10	22 – 10
Rated current	¹⁾	¹⁾	10 A ¹⁾
Rated voltage	500 V ²⁾	600 V ²⁾	300 V ²⁾
Rated impulse voltage	8 kV		
Pollution degree	3		

ACCESSORIES

Description	Type	Part No.	Std. Pack
End plate	gray APFN 4 D2/2	07.312.9055.0	10
Intermediate plate, 4 mm	gray ZP/WKFN 4 TKG	07.313.1655.0	10
Partition	gray TWFN 4 D2/2	07.312.9155.0	10

INFO AND ACCESSORIES FOR FASIS WKFN 4 TKG WITH THSI

¹⁾ The current is determined by the inserted fuse.

²⁾ The voltage range is determined by the built-in LED display.

Depending on the application and the installation method, the circumstances for increased temperature must be checked in the closed fuse holders.

Higher ambient temperatures are an additional load for the fuse inserts. Therefore, the reduction of the rated current must be considered accordingly in these applications.

Indicator (24 V): LED, red
current consumption: 10.3 mA

Indicator (220 V): LED, red
current consumption: 0.3 mA

When selecting G fuse inserts, make sure that the specified maximum power is not exceeded.
Maximum power loss at 23°C ambient temperature (according to DIN EN 60947-7-3)

Type	Rated voltage	Overload protection		Exclusive short-circuit protection	
		Single arrangement	Group arrangement	Single arrangement	Group arrangement
THSI 5x20	250 V	1.6 W	1.6 W	4.0 W	2.5 W
THSI 6,3x32	500 V	2.5 W	1.6 W	4.0 W	2.5 W

ACCESSORIES	Type	Part No.	Std. Pack	
Cross connector, insulated	2-pole IVB WKF 4-2	Z7.261.1227.0	10	
for WKFN 4 TKG with THSi 5x20	3-pole IVB WKF 4-3	Z7.261.1327.0	10	
	4-pole IVB WKF 4-4	Z7.261.1427.0	10	
	5-pole IVB WKF 4-5	Z7.261.1527.0	10	
	6-pole IVB WKF 4-6	Z7.261.1627.0	10	
	7-pole IVB WKF 4-7	Z7.261.1727.0	20	
	8-pole IVB WKF 4-8	Z7.261.1827.0	20	
	9-pole IVB WKF 4-9	Z7.261.1927.0	20	
	10-pole IVB WKF 4-10	Z7.261.2027.0	20	
Wire entry guide	0.13 – 0.2 mm ²	LEL 4/1 WEISS	05.561.8553.0	100
	0.25 – 0.5 mm ²	LEL 4/2 GRAU	05.561.8653.0	100
	0.75 – 1.0 mm ²	LEL 4/3 SCHWARZ	05.561.8753.0	100
Cover with warning symbol over 4 blocks	yellow ADF 4/4 GELB	04.343.6153.8	10	
Test adapter, modular	ST 2/2,3	Z5.553.2921.0	10	
Screwdriver, uninsulated	DIN 5264 B 0,6x3,5	06.502.4000.0	5	
Screwdriver, uninsulated, MINI	DIN 5264 B 0,6x3,5 M	06.502.5000.0	10	

For WKFN 4 TKG with THSi 6.3x32 and intermediate plate cross connector IVB WKF 2,5-x must be used.

WKFN 4 TKG WITH SIST

- Disconnect block with tension spring connection for mounting on TS 35
- Nominal cross section 4 mm²

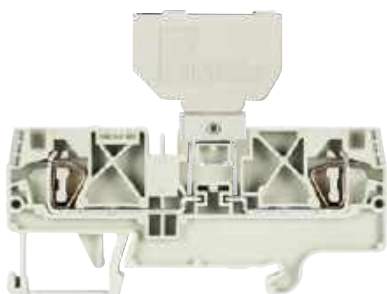

Description	Type	Part No.	Std. Pack
Disconnect block	gray WKFN 4 TKG/35	56.704.4055.0	100
Fuse holder for fuse 5 x 20	Si ST	Z1.299.4055.0	10
Fuse holder with indicator (24V) ²⁾	Si ST LED	Z1.299.4155.0	10
Fuse holder with indicator (220V) ²⁾	Si ST GL	Z1.299.4255.0	10

GENERAL DATA

Width / length / height, incl. TS 7.5	6 mm / 82 mm / 38 mm
Wire strip length	11 mm
Approvals	

TECHNICAL DATA	IEC	UL	CSA
	EN 60 947-7-3		
Cross section fine-stranded	0.13 – 4 mm ²		
Cross section solid/stranded	0.13 – 6 mm ²		
Cross section, AWG		24 – 10	22 – 10
Rated current	1) ¹⁾	1) ¹⁾	10 A ¹⁾
Rated voltage	500 V ²⁾	600 V ²⁾	300 V ²⁾
Rated impulse voltage	8 kV		
Pollution degree	3		

ACCESSORIES	Type	Part No.	Std. Pack
End plate	gray APFN 4 D2/2	07.312.9055.0	10
Partition	gray TWFN 4 D2/2	07.312.9155.0	10

WKFN 4 TKG WITH DIST

- Disconnect block with tension spring connection for mounting on TS 35
- Nominal cross section 4 mm²

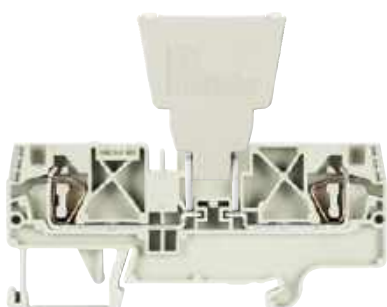

Description	Type	Part No.	Std. Pack
Disconnect block	gray WKFN 4 TKG/35	56.704.4055.0	100
Diode plug – empty	J _{max} = 10 A ¹⁾ DIST ...	Z1.299.3055.0	10
Diode plug – diode	J _{max} = 1 A ¹⁾ DIST-1 N 4007-1 ³⁾	Z1.299.3155.0	10
Diode plug – diode	J _{max} = 1 A ¹⁾ DIST-1 N 4007-2 ⁴⁾	Z1.299.3355.0	10
Diode plug with jumper	J _{max} = 10 A ¹⁾ DIST-D	Z1.299.3255.0	10

GENERAL DATA

Width / length / height, incl. TS 7.5	6 mm / 82 mm / 38 mm
Wire strip length	11 mm
Approvals	

TECHNICAL DATA	IEC	UL	CSA
	EN 60 947-7-3		
Cross section fine-stranded	0.13 – 4 mm ²		
Cross section solid/stranded	0.13 – 6 mm ²		
Cross section, AWG		24 – 10	22 – 10
Rated current	1) ¹⁾	1) ¹⁾	10 A ¹⁾
Rated voltage	500 V ²⁾	600 V ²⁾	300 V ²⁾
Rated impulse voltage	8 kV		
Pollution degree	3		

ACCESSORIES	Type	Part No.	Std. Pack
End plate	gray APFN 4 D2/2	07.312.9055.0	10
Partition	gray TWFN 4 D2/2	07.312.9155.0	10

INFO AND ACCESSORIES FOR FASIS WKFN 4 TKG WITH SIST AND DIST

¹⁾ The current is determined by the inserted fuse.

²⁾ The voltage range is determined by the built-in LED display.

Depending on the application and the installation method, the circumstances for increased temperature must be checked in the closed fuse holders.

Higher ambient temperatures are an additional load for the fuse inserts. Therefore, the reduction of the rated current must be considered accordingly in these applications.

Indicator (24 V): LED, red
current consumption: 10.3 mA

Indicator (220 V): LED, red
current consumption: 0.3 mA

^{3)/4)} Periodic peak voltage 1000 V
Direction of the diode: Anode Cathode³⁾
Cathode Anode⁴⁾

When selecting G fuse inserts, make sure that the specified maximum power is not exceeded.
Maximum power loss at 23° C ambient temperature (according to DIN EN 60947-7-3)

Type	Rated voltage	Overload protection		Exclusive short-circuit protection	
		Single arrangement	Group arrangement	Single arrangement	Group arrangement
SIST	250 V	1.6 W	1.6 W	2.5 W	1.6 W

ACCESSORIES	Type	Part No.	Std. Pack	
Cross connector, insulated	2-pole	IVB WKF 4-2	Z7.261.1227.0	10
	3-pole	IVB WKF 4-3	Z7.261.1327.0	10
	4-pole	IVB WKF 4-4	Z7.261.1427.0	10
	5-pole	IVB WKF 4-5	Z7.261.1527.0	10
	6-pole	IVB WKF 4-6	Z7.261.1627.0	10
	7-pole	IVB WKF 4-7	Z7.261.1727.0	20
	8-pole	IVB WKF 4-8	Z7.261.1827.0	20
	9-pole	IVB WKF 4-9	Z7.261.1927.0	20
	10-pole	IVB WKF 4-10	Z7.261.2027.0	20
	Wire entry guide	0.13 – 0.2 mm ²	LEL 4/1 WEISS	05.561.8553.0
0.25 – 0.5 mm ²		LEL 4/2 GRAU	05.561.8653.0	100
0.75 – 1.0 mm ²		LEL 4/3 SCHWARZ	05.561.8753.0	100
Cover with warning symbol over 4 blocks	yellow	ADF 4/4 GELB	04.343.6153.8	10
Test adapter, modular		ST 2/2,3	Z5.553.2921.0	10
Screwdriver, uninsulated		DIN 5264 B 0,6x3,5	06.502.4000.0	5
Screwdriver, uninsulated, MINI		DIN 5264 B 0,6x3,5 M	06.502.5000.0	10

Technical information see FACTS & DATA page 158 ff.

Subject to technical modifications

FASIS WKFN · FUSE BLOCKS WITH TENSION SPRING CONNECTION

WKFN 4 FSI

- Fuse block for automobile fuses for mounting on TS 35
- Nominal cross section 4 mm²

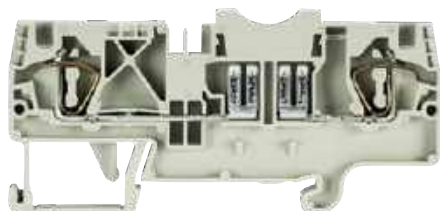

Description	Type	Part No.	Std. Pack
Fuse block	gray WKFN 4 FSI	56.704.4155.0	100

GENERAL DATA

Width / length / height, incl. TS 7.5	6 mm / 82 mm / 39 mm
Wire strip length	12 mm
Approvals	☉

TECHNICAL DATA

	IEC
	EN 60947-7-3
Cross section fine-stranded	0.13 – 4 mm ²
Cross section solid/stranded	0.13 – 6 mm ²
Cross section, AWG	
Rated current	*
Rated voltage	800 V
Rated impulse voltage	8 kV
Pollution degree	3

Note

* Observe the derating curve, available in our e-catalog at <https://eshop.wieland-electric.com>

ACCESSORIES	Type	Part No.	Std. Pack
End plate	gray APFN 4 D2/2	07.312.9055.0	10
Partition, 4 mm for TCP	gray ZP/WKFN 4 TKG	07.313.1655.0	10
Partition	gray TWFN 4 D2/2	07.312.9155.0	10

WKFN 4 FSI

- Fuse block with indicator for mounting on TS 35
- Nominal cross section 4 mm²

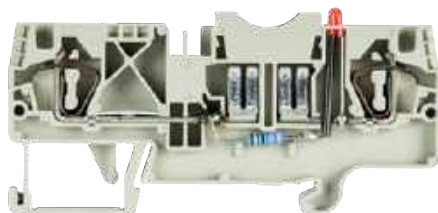

Description	Type	Part No.	Std. Pack
Fuse block	gray WKFN 4 FSI LED12	56.704.4255.0	100
Fuse block	gray WKFN 4 FSI LED24	56.704.5355.0	100

GENERAL DATA

Width / length / height, incl. TS 7.5	6 mm / 82 mm / 39 mm
Wire strip length	12 mm
Approvals	☉

TECHNICAL DATA

	IEC
	EN 60947-7-3
Cross section fine-stranded	0.13 – 4 mm ²
Cross section solid/stranded	0.13 – 6 mm ²
Cross section, AWG	
Rated current	*
Rated voltage	800 V
Rated impulse voltage	8 kV
Pollution degree	3

Note

* Observe the derating curve, available in our e-catalog at <https://eshop.wieland-electric.com>

ACCESSORIES	Type	Part No.	Std. Pack
End plate	gray APFN 4 D2/2	07.312.9055.0	10
Partition, 4 mm for TCP	gray ZP/WKFN 4 TKG	07.313.1655.0	10
Partition	gray TWFN 4 D2/2	07.312.9155.0	10

AUTOMOTIVE FUSES

The WKFN 4 FSI .. type fuse blocks take blade-type fuses according to ISO 8820 (DIN 72581-3).

Automotive fuses are not offered for sale by Wieland Electric!

We recommend the following:



Description	Color	
Blade-type automobile fuse, DC 32 V	black	1 A
Electrotechnical specialized trade	gray	2 A
Motor vehicle accessory market	violet	3 A
	pink	4 A
	beige	5 A
	brown	7.5 A
	red	10 A
	blue	15 A
	yellow	20 A
Thermal circuit breaker, DC 32 V		5 A
ETA*, type 1610-21 or		6 A
ETA*, type 1610-H2 with manual release		10 A
		15 A
		20 A
Thermal circuit breaker, AC 250 V; DC 65 V		0.1 A
ETA*, type 1180 ..		0.2 A
		0.5 A
		1 A
		2 A
		3 A
		4 A
		6 A
		8 A
		10 A

* E-T-A Elektrotechnische Apparate GmbH, www.e-t-a.de

More accessories page 130 ff.

FASIS WKFN · SUPPLY TERMINAL

WKF 16/35 PV/WKFN

- Supply terminal for mounting on TS 35
- Nominal cross section 16 mm²
- Ex e I/II  II 2GD IM2
Follow the EX installation instructions on page 160



Description	Type	Part No.	Std. Pack
Supply terminal	gray WKF 16/35 PV/WKFN	56.716.0353.0	20

GENERAL DATA			
Width / length / height, incl. TS 7.5	12 mm / 82 mm / 48 mm		
Wire strip length	15 mm		
Approvals			KEMA 01 ATEX 2087 U

TECHNICAL DATA	IEC	UL	CSA	
	EN 60 947-7-3			EN 60 079-0/-7
Cross section fine-stranded	4 – 16 mm ²			4 – 16 mm ²
Cross section solid/stranded	4 – 16 mm ²			4 – 16 mm ²
Cross section, AWG		24 – 4	12 – 4	
Rated current	76 A	75 A	78 A	64 A ¹⁾
Rated voltage	800 V	600 V	600 V	690 V
Rated impulse voltage	8 kV			
Pollution degree	3			

Note ¹⁾ Derating curves available on request

ACCESSORIES	Type	Part No.	Std. Pack
Cover with warning symbol over 4 blocks	ADF 16/4 GELB	04.343.6653.8	10
Screwdriver, uninsulated	DIN 5264 B 1,0x5,5	06.502.4200.0	5

POTENTIAL DISTRIBUTION

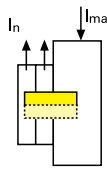
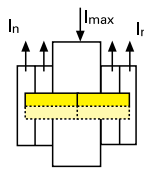
Potential distribution				
Jumpering	one side		both sides	
IVB WKF 4...	single	double	single	double
I _{max}	64	76	76	76
I _{Nblock}	32	32	32	32

$$I_{\max} = \sum I_n \leq \sum I_{N \text{ block}}$$

ACCESSORIES FOR FASIS WKFN 4 FSI



ACCESSORIES	Type	Part No.	Std. Pack	
Cross connector, insulated, for	2 blocks	IVB WKF 4 – 2	Z7.261.1227.0	10
	3 blocks	IVB WKF 4 – 3	Z7.261.1327.0	10
	4 blocks	IVB WKF 4 – 4	Z7.261.1427.0	10
	5 blocks	IVB WKF 4 – 5	Z7.261.1527.0	10
	6 blocks	IVB WKF 4 – 6	Z7.261.1627.0	10
	7 blocks	IVB WKF 4 – 7	Z7.261.1727.0	20
	8 blocks	IVB WKF 4 – 8	Z7.261.1827.0	20
	9 blocks	IVB WKF 4 – 9	Z7.261.1927.0	20
	10 blocks	IVB WKF 4 – 10	Z7.261.2027.0	20
	Wire entry guide	0.13 – 0.2 mm ²	LEL 4/1 WEISS	05.561.8553.0
0.25 – 0.5 mm ²		LEL 4/2 GRAU	05.561.8653.0	100
0.75 – 1.0 mm ²		LEL 4/1 SCHWARZ	05.561.8753.0	100
Cover with warning symbol over 4 blocks	yellow	ADF 4/4 GELB	04.343.6153.8	10
Screwdriver, uninsulated		DIN 5264 B 0,6x3,5	06.502.4000.0	5
Screwdriver, uninsulated, MINI		DIN 5264 B 0,6x3,5 M	06.502.5000.0	10

Technical information see FACTS & DATA page 158 ff.

Subject to technical modifications

FASIS CON – DIN RAIL TERMINAL BLOCKS WITH PLUG-IN CONNECTION

fasis CON is a DIN rail terminal block system with a pluggable outgoing feeder, which offers modular, cost-saving solutions with advantages in every phase of the service life of an electrical system.

fasis CON is a fully compatible part of the established fasis WKFN system. Both the terminal and the plug connector possess the high-performance features of fasis WKFN.

fasis CON consists of feed-through and ground DIN rail terminal blocks with a wide variety of both wiring termination points and sockets for the fasis CON pluggable connectors.

fasis CON is a cost-effective, high-performance and pluggable system solution.



COST-EFFECTIVE

- Cost-optimized installation and maintenance times
- Small numbers of components
- Can be assembled individually
- Pre-assembled modules

PLUGGABLE

- Complex systems can be brought on-line quickly and cost-effectively with pluggable technology
- Functional units can be tested easily
- Field components can be more quickly replaced when faults occur
- Systems can be expanded with pluggable technology

COMPLETE SYSTEM

- Uniform accessories
- Coded to prevent mismatching
- All components can be jumpered
- Comprehensive and clear labeling
- Can be combined with fasis WKFN

TECHNICAL DATA:

- Range of terminals: up to 4 mm²
- Rated current: up to 32 A IEC / 20 A UL, CSA*

- Rated voltage: 500 V
- Total width only: 5 mm

* Observe the derating curve, available in our online-catalog at <https://eshop.wieland-electric.com>

FASIS CON – THE SYSTEM AT A GLANCE

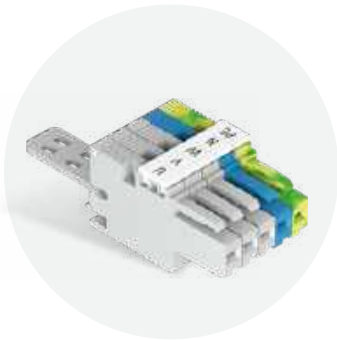

The connectors

- Can be assembled for specific applications
- Pre-assembly possible
- Also single-pole for test purposes

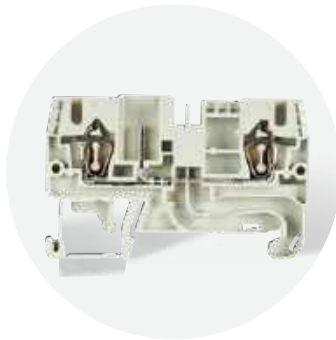

The terminals

- Universally applicable
- Plug-in and spring-cage connections
- Can also be used as “standard” feed-through terminal



Integrated safety

- Touch protection in not connected connection
- IP20 in connected connection
- No further accessories required, as all connectors have built-in latching mechanism and coding options



The labeling system

- All termination points can be clearly labeled using the standard Wieland labeling system.



The jumpering system

- The standard Wieland push-in jumper system can be used in both the modular terminal and in the plug-in connector.
- All basic terminals are fully compatible with the fasis WKFN-series, including the 16 mm² feed-in terminal.
- The modular terminal block's integrated jumper channel maintains a permanent feed-through connection even when the plug is not installed.

FASIS CON · DIN RAIL TERMINAL BLOCKS WITH PLUG-IN CONNECTION

WKFN 2,5 F/P/F

- DIN rail terminal blocks with plug-in connection for mounting on TS 35
- Nominal cross section 2.5 mm²



Description	Type	Part No.	Std. Pack
Feed-through block F/P/F	gray	WKFN 2,5 F/P/F	56.703.2355.0 100
Feed-through block F/P/F	blue	WKFN 2,5 F/P/F	56.703.2355.6 100
Ground block	green/yellow	WKFN 2,5 F/P/F-SL	56.703.2455.0 100

GENERAL DATA			
Width / length / height, incl. TS 7.5	5 mm / 60 mm / 39 mm		
Wire strip length	11 mm		
Approvals			

TECHNICAL DATA	IEC	UL	CSA
	EN 60947-7-1/-2		
Cross section fine-stranded	0.13 – 4 mm ²		
Cross section solid/stranded	0.13 – 4 mm ²		
Cross section, AWG		24 – 12	24 – 12
Rated current	32 A*	20 A	20 A
Rated voltage	500 V	500 V	500 V
Rated impulse voltage	8 kV		
Pollution degree	3		

Note * Observe the derating curve, available in our e-catalog at <https://eshop.wieland-electric.com>

ACCESSORIES	Type	Part No.	Std. Pack
End plate	gray	APFN 2,5 D1/2	07.312.6955.0 10
End plate	blue	APFN 2,5 D1/2 BLAU	07.312.6955.6 10
Partition	gray	TWFN 2,5 D1/2	07.312.7055.0 10

WKFN 2,5 2P/2F

- DIN rail terminal blocks with plug-in connection for mounting on TS 35
- Nominal cross section 2.5 mm²



Description	Type	Part No.	Std. Pack
Feed-through block 2P/2F	gray	WKFN 2,5 2P/2F	56.703.2155.0 100
Feed-through block 2P/2F	blue	WKFN 2,5 2P/2F	56.703.2155.6 100
Ground block	green/yellow	WKFN 2,5 2P/2F-SL	56.703.2255.0 100

GENERAL DATA			
Width / length / height, incl. TS 7.5	5 mm / 85 mm / 39 mm		
Wire strip length	11 mm		
Approvals			

TECHNICAL DATA	IEC	UL	CSA
	EN 60947-7-1/-2		
Cross section fine-stranded	0.13 – 4 mm ²		
Cross section solid/stranded	0.13 – 4 mm ²		
Cross section, AWG		24 – 12	24 – 12
Rated current	32 A*	20 A	20 A
Rated voltage	500 V	500 V	500 V
Rated impulse voltage	8 kV		
Pollution degree	3		

Note * Observe the derating curve, available in our e-catalog at <https://eshop.wieland-electric.com>

ACCESSORIES	Type	Part No.	Std. Pack
End plate	gray	APFN 2,5 TKM D2/2	07.313.0055.0 10
Partition	gray	TWFN 2,5 TKM D2/2	07.313.0155.0 10

WKFN 2,5 E/././..

- Multi-tier blocks with plug-in connection for mounting on TS 35
- Nominal cross section 2.5 mm²

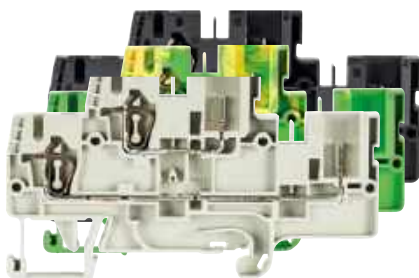

Description	Type	Part No.	Std. Pack
Multi-tier block E/F/P	gray	WKFN 2,5 E/F/P	56.703.3455.0 100
Multi-tier block, vertically connected	black	WKFN 2,5 E/VB/F/P	56.703.3555.1 100
Multi-tier ground block	green/yellow	WKFN 2,5 E/F/P/SL	56.703.3655.0 100

GENERAL DATA			
Width / length / height, incl. TS 7.5	5 mm / 82 mm / 49 mm		
Wire strip length	11 mm		
Approvals			

TECHNICAL DATA	IEC	UL	CSA
	EN 60947-7-1/-2		
Cross section fine-stranded	0.13 – 4 mm ²		
Cross section solid/stranded	0.13 – 4 mm ²		
Cross section, AWG		24 – 12	24 – 12
Rated current	22 A*	20 A	20 A
Rated voltage	500 V	500 V	500 V
Rated impulse voltage	8 kV		
Pollution degree	3		

Note * Observe the derating curve, available in our e-catalog at <https://eshop.wieland-electric.com>

ACCESSORIES	Type	Part No.	Std. Pack
End plate	gray	APFN 2,5 E	07.312.7355.0 10
Partition	gray	TWFN 2,5 E	07.312.7455.0 10

FASIS CON · CONNECTORS

WBF 2,5/..../.

- Connectors for DIN rail terminal blocks with plug-in connection

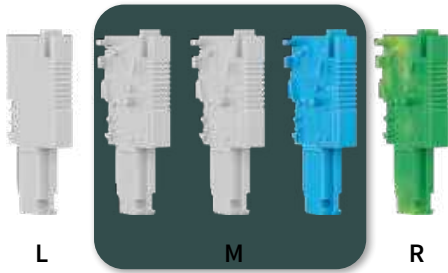

Description	Type	Part No.	Std. Pack
Connectors LEFT			
	gray WBF 2,5 1/L/GR	Z1.110.8955.0	50
	blue WBF 2,5 1/L/BL	Z1.110.8955.6	50
	green/yellow WBF 2,5 1/L/SL	Z1.110.8955.7	50
Connectors MIDDLE			
	gray WBF 2,5 1/M/GR	Z1.110.8855.0	50
	blue WBF 2,5 1/M/BL	Z1.110.8855.6	50
	green/yellow WBF 2,5 1/M/SL	Z1.110.8855.7	50
Connectors RIGHT			
	gray WBF 2,5 1/R/GR	Z1.110.9055.0	50
	blue WBF 2,5 1/R/BL	Z1.110.9055.6	50
	green/yellow WBF 2,5 1/R/SL	Z1.110.9055.7	50
Connectors preassembled, gray			
	1-pole WBF 2,5-1	59.903.0155.0	50
	2-pole WBF 2,5-2	59.903.0255.0	50
	3-pole WBF 2,5-3	59.903.0355.0	50
	4-pole WBF 2,5-4	59.903.0455.0	50
	5-pole WBF 2,5-5	59.903.0555.0	50
	6-pole WBF 2,5-6	59.903.0655.0	25
	7-pole WBF 2,5-7	59.903.0755.0	25
	8-pole WBF 2,5-8	59.903.0855.0	25
	9-pole WBF 2,5-9	59.903.0955.0	25
	10-pole WBF 2,5-10	59.903.1055.0	25

GENERAL DATA				
Width / length / height, incl. TS 7.5	5 mm			
Wire strip length	11 mm			
Approvals				
TECHNICAL DATA		IEC	UL	CSA
		EN 60947-7-1/-2		
Cross section fine-stranded	0.13 – 4 mm ²			
Cross section solid/stranded	0.13 – 4 mm ²			
Cross section, AWG			24 – 12	24 – 12
Rated current	32 A*		20 A	20 A
Rated voltage	500 V		500 V	500 V
Rated impulse voltage	8 kV			
Pollution degree	3			

Note * Observe the derating curve, available in our e-catalog at <https://eshop.wieland-electric.com>

ACCESSORIES	Type	Part No.	Std. Pack
Strain relief	Z-WBF	05.567.9155.0	10
Screwdriver, uninsulated	DIN 5264 B 0,6x3,5	06.502.4000.0	10
Screwdriver, MINI	DIN 5264 B 0,6x3,5 M	06.502.5000.0	10

ACCESSORIES FOR FASIS WKFN 2,5

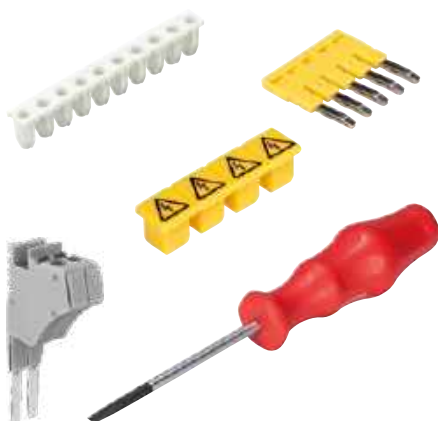

ACCESSORIES	Type	Part No.	Std. Pack
Cross connector, insulated, for	2 blocks IVB WKFN 2,5-2	Z7.280.6227.0	10
	3 blocks IVB WKFN 2,5-3	Z7.280.6327.0	10
	4 blocks IVB WKFN 2,5-4	Z7.280.6427.0	10
	5 blocks IVB WKFN 2,5-5	Z7.280.6527.0	10
	6 blocks IVB WKFN 2,5-6	Z7.280.6627.0	10
	7 blocks IVB WKFN 2,5-7	Z7.280.6727.0	20
	8 blocks IVB WKFN 2,5-8	Z7.280.6827.0	20
	9 blocks IVB WKFN 2,5-9	Z7.280.6927.0	20
	10 blocks IVB WKFN 2,5-10	Z7.280.7027.0	20
	20 blocks IVB WKFN 2,5-20	Z7.280.8027.0	20
Wire entry guide	0.13 – 0.2 mm ² LELN 2,5/1 WEISS	05.564.3755.0	100
	0.25 – 0.5 mm ² LELN 2,5/1 Grins	05.564.3855.0	100
	0.75 – 1.0 mm ² LELN 2,5/1 SCHWARZ	05.564.3955.0	100
Cover with warning symbol over 4 blocks	yellow ADFN 2,5/4 GELB	04.343.8353.8	10
Test adapter, modular	PS WKFN/F	Z1.299.9753.0	10
Screwdriver, uninsulated	DIN 5264 B 0,6x3,5	06.502.4000.0	5
Screwdriver, uninsulated, MINI	DIN 5264 B 0,6x3,5 M	06.502.5000.0	10

Technical information see FACTS & DATA page 158 ff.

Subject to technical modifications

FASIS · DIN RAIL TERMINAL BLOCKS WITH TENSION SPRING AND PLUGGABLE CONNECTIONS

WKF 2,5 D2/8113/35

- Duo feed-through block for mounting on TS 35
- Nominal cross section 2.5 mm²

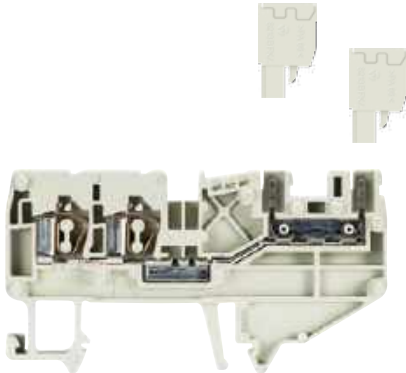

Description	Type	Part No.	Std. Pack	
Duo feed-through block	gray	WKF 2,5 D2/8113/35	56.703.2053.0	100
Duo feed-through block	blue	WKF 2,5 D2/8113/35 BLAU	56.703.2053.6	100

General data				
Width / length / height, incl. TS 7.5	5 mm / 76 mm / 42 mm			
Wire strip length	11 mm			
Approvals				
TECHNICAL DATA		IEC	UL	CSA
		EN 60947-7-1		
Cross section fine-stranded	0.13 – 2.5 mm ²			
Cross section solid/stranded	0.13 – 4 mm ²			
Cross section, AWG		22 – 12	24 – 12	
Rated current	16 A	15 A	15 A	
Rated voltage	250 V	300 V	300 V	
Rated impulse voltage	4 kV			
Pollution degree	3			
ACCESSORIES		Type	Part No.	Std. Pack
End plate	gray	APF 2,5/D2/8113	07.312.4153.0	10
End plate	blue	APF 2,5/D2/8113	07.312.4153.6	10
Wire entry guide	0.13 – 0.2 mm ²	LEL 2,5/1 WEISS	05.561.6553.0	100
	0.25 – 0.5 mm ²	LEL 2,5/2 Grins	05.561.6653.0	100
	0.75 – 1.0 mm ²	LEL 2,5/3 SCHWARZ	05.561.6753.0	100
Cover with warning symbol over 4 blocks	ADF 2,5/4 GELB		04.343.6053.8	10

WKF 2,5 D2/8113/SL/35

- Duo-ground block for mounting on TS 35
- Nominal cross section 2.5 mm²

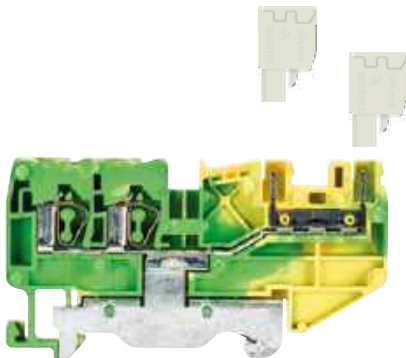

Description	Type	Part No.	Std. Pack	
Duo-ground block	green/yellow	WKF 2,5 D2/8113 SL/35	56.703.9253.0	100

GENERAL DATA				
Width / length / height, incl. TS 7.5	5 mm / 76 mm / 42 mm			
Wire strip length	11 mm			
Approvals				
TECHNICAL DATA		IEC	UL	CSA
		EN 60947-7-1		
Cross section fine-stranded	0.13 – 2.5 mm ²			
Cross section solid/stranded	0.13 – 4 mm ²			
Cross section, AWG		22 – 12	24 – 12	
Rated current	16 A	300 V	300 V	
Rated voltage	250 V	300 V	300 V	
Rated impulse voltage	4 kV			
Pollution degree	3			
ACCESSORIES		Type	Part No.	Std. Pack
End plate	gray	APF 2,5/D2/8113	07.312.4153.0	10
Wire entry guide	0.13 – 0.2 mm ²	LEL 2,5/1 WEISS	05.561.6553.0	100
	0.25 – 0.5 mm ²	LEL 2,5/2 Grins	05.561.6653.0	100
	0.75 – 1.0 mm ²	LEL 2,5/3 SCHWARZ	05.561.6753.0	100
Cover with warning symbol over 4 blocks	ADF 2,5/4 GELB		04.343.6053.8	10

WKF 1,5 E/8113/35

- Multi-tier block for mounting on TS 35
- Nominal cross section 1.5 mm²

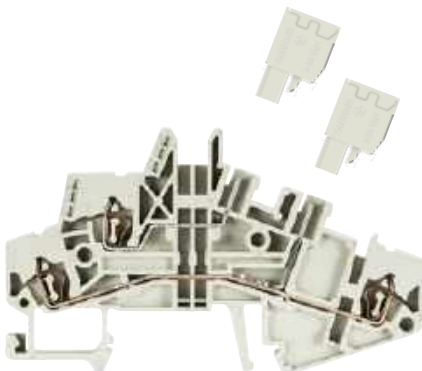

Description	Type	Part No.	Std. Pack	
Multi-tier block	gray	WKF 1,5 E/8113/35	56.702.2053.0	100

GENERAL DATA				
Width / length / height, incl. TS 7.5	5 mm / 83 mm / 51 mm			
Wire strip length	8 mm			
Approvals				
TECHNICAL DATA		IEC	UL	CSA
		EN 60947-7-1		
Cross section fine-stranded	0.13 – 1.5 mm ²			
Cross section solid/stranded	0.13 – 2.5 mm ²			
Cross section, AWG		22 – 12	24 – 12	
Rated current	16 A			
Rated voltage	250 V			
Rated impulse voltage	4 kV			
Pollution degree	3			
ACCESSORIES		Type	Part No.	Std. Pack
End plate	gray	APF 1,5/E/8113	07.312.4753.0	10
Wire entry guide	0.13 – 0.2 mm ²	LEL 1,5/1 WEISS	05.562.2453.0	100
	0.25 – 0.5 mm ²	LEL 1,5/2 Grins	05.562.2553.0	100
	0.75 – 1.0 mm ²	LEL 1,5/3 SCHWARZ	05.562.2653.0	100
Cover with warning symbol over 4 blocks	ADF 1,5/4 GELB		04.343.8353.8	10

WKF 1,5 E/35

- Multi-tier block for mounting on TS 35
- Nominal cross section 1.5 mm²

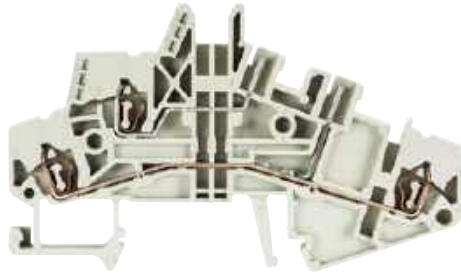

Description	Type	Part No.	Std. Pack
Multi-tier block	gray WKF 1,5 E/35	56.702.7053.0	100

GENERAL DATA

Width / length / height, incl. TS 7.5	5 mm / 83 mm / 51 mm
Wire strip length	8 mm
Approvals	

TECHNICAL DATA	IEC	UL	CSA
	EN 60947-7-1		
Cross section fine-stranded	0.13 – 1.5 mm ²		
Cross section solid/stranded	0.13 – 2.5 mm ²		
Cross section, AWG		30 – 14	30 – 14
Rated current	17,5 A	15 A	15 A
Rated voltage	400 V	300 V	600 V
Rated impulse voltage	6 kV		
Pollution degree	3		

ACCESSORIES	Type	Part No.	Std. Pack
End plate	gray APF 1,5 E	07.312.3553.0	10
Partition	gray TWF 1,5 E	07.312.3653.0	10
Wire entry guide	0.13 – 0.2 mm ² LEL 1,5/1 WEISS	05.562.2453.0	100
	0.25 – 0.5 mm ² LEL 1,5/2 Grins	05.562.2553.0	100
	0.75 – 1.0 mm ² LEL 1,5/3 SCHWARZ	05.562.2653.0	100
Cover with warning symbol over 4 blocks	ADF 1,5/4 GELB	04.343.8353.8	10

WIECON PC BOARD CONNECTOR

TYPE 8113 BFK

- Spring clamp/tension spring system
- 5 mm spacing, nominal cross section 2,5 mm²
- Accessories: coding pice 05.561.9153.0
- Rated voltages: VDE 0110/01.89
250 V/4 kV/3 – Overvoltage category III
400 V/4 kV/2 – Overvoltage category II
1000 V/4 kV/1 – Overvoltage category I

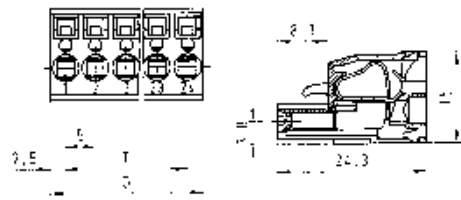

G	T	Pole	Part No.	Part No.	Std. Pack
5 mm spacing					
			unmarked	marked	
10.00	5.00	2	25.920.3253.0	25.920.0253.0	100
15.00	10.00	3	25.920.3353.0	25.920.0353.0	100
20.00	15.00	4	25.920.3453.0	25.920.0453.0	50
25.00	20.00	5	25.920.3553.0	25.920.0553.0	50
30.00	25.00	6	25.920.3653.0	25.920.0653.0	50
35.00	30.00	7	25.920.3753.0	25.920.0753.0	50
40.00	35.00	8	25.920.3853.0	25.920.0853.0	50
45.00	40.00	9	25.920.3953.0	25.920.0953.0	50
50.00	45.00	10	25.920.4053.0	25.920.1053.0	50
55.00	50.00	11	25.920.4153.0	25.920.1153.0	50
60.00	55.00	12	25.920.4253.0	25.920.1253.0	50
65.00	60.00	13	25.920.4353.0	25.920.1353.0	50
70.00	65.00	14	25.920.4453.0	25.920.1453.0	50
75.00	70.00	15	25.920.4553.0	25.920.1553.0	50
80.00	75.00	16	25.920.4653.0	25.920.1653.0	50

17- to 24-pole configurations upon request

GENERAL DATA

Wire strip length	9 mm
Approvals	

TECHNICAL DATA	IEC	UL	CSA
	EN 60947-7-1		
Cross section fine-stranded	0.13 – 2.5 mm ²		
Cross section solid/stranded	0.13 – 4 mm ²		
Cross section, AWG		22 – 12	22 – 12
Rated current	12 A	12 A	12 A
Rated voltage		300 V	300 V
Rated impulse voltage			
Pollution degree			

ACCESSORIES FOR FASIS WKF 2,5 D AND WKF 1,5 E



ACCESSORIES	Type	Part No.	Std. Pack
Cross connector, insulated	2-pole IVB WKF 2,5 – 2	Z7.280.6227.0	10
	3-pole IVB WKF 2,5 – 3	Z7.280.6327.0	10
	4-pole IVB WKF 2,5 – 4	Z7.280.6427.0	10
	5-pole IVB WKF 2,5 – 5	Z7.280.6527.0	10
	6-pole IVB WKF 2,5 – 6	Z7.280.6627.0	10
	7-pole IVB WKF 2,5 – 7	Z7.280.6727.0	20
	8-pole IVB WKF 2,5 – 8	Z7.280.6827.0	20
	9-pole IVB WKF 2,5 – 9	Z7.280.6927.0	20
	10-pole IVB WKF 2,5 – 10	Z7.280.7027.0	20
	20-pole IVB WKF 2,5 – 20	Z7.280.8027.0	20
Cover with warning symbol over 4-poles	yellow AD 8113/4 GELB	04.343.6853.8	10
Screwdriver, uninsulated	DIN 5264 B 0,6x3,5	06.502.4000.0	5
Coding strip		05.561.0053.0	100

Technical information see FACTS & DATA page 158 ff.

Subject to technical modifications

INITIATOR AND ACTUATOR BLOCKS WITH TENSION SPRING CONNECTION

For machine and system control wiring, practice-oriented solutions are preferred that are primarily economical and reliable and thus contribute to the system's operational and functional safety.



WKF 1,5 KOI 3L...

- Initiator block with tension spring connection for mounting on TS 35
- Nominal cross section 1.5 mm²

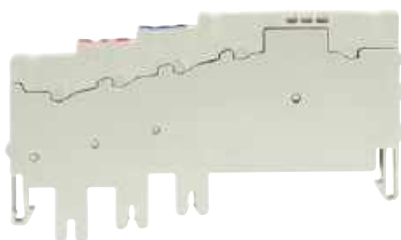

37.702.7453.0
* 65 V/1.5 kV/3

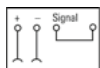

37.702.8453.0
* DC 24 V
same as picture,
but with LED

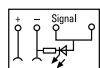

Description	Type	Part No.	Std. Pack
Initiator block	gray WKF 1,5 KOI 3L	37.702.7453.0	50
Initiator block with LED	gray WKF 1,5 KOI 3L-PGE	37.702.8453.0	50

GENERAL DATA

Width / length / height, incl. TS 7.5	5 mm / 71 mm / 48 mm
Wire strip length	10 mm
Approvals	

TECHNICAL DATA

IEC	UL	CSA
EN 60947-7-1		
Cross section fine-stranded	0.13 – 1.5 mm ²	
Cross section solid/stranded	0.13 – 1.5 mm ²	
Cross section, AWG	22 – 16	28 – 16
Rated current	10 A	10 A
Rated voltage	*	65 V
Rated impulse voltage	65 V	
Pollution degree		

ACCESSORIES

Type	Part No.	Std. Pack
Wire entry guide	0.13 – 0.2 mm ² LEL 1,5/1 WEISS	05.562.2453.0 100
	0.25 – 0.5 mm ² LEL 1,5/2 Grins	05.562.2553.0 100
	0.75 – 1.0 mm ² LEL 1,5/3 SCHWARZ	05.562.2653.0 100
Screwdriver, uninsulated	DIN 5264 B 0,6x3,5	06.502.4000.0 5

WKF 1,5 KOI 3L/SL...

- Initiator block with tension spring connection for mounting on TS 35
- Nominal cross section 1.5 mm²

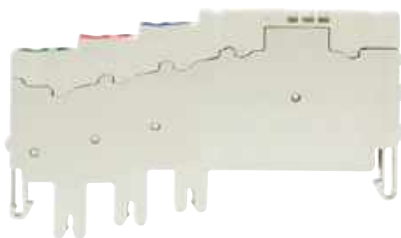

37.702.7553.0
* 65 V/1.5 kV/3

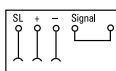

37.702.8553.0
* DC 24 V
same as picture,
but with LED

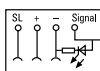

Description	Type	Part No.	Std. Pack
Initiator block	gray WKF 1,5 KOI 3L/SL	37.702.7553.0	50
Initiator block with LED	gray WKF 1,5 KOI 3L/SL-PGE	37.702.8553.0	50

GENERAL DATA

Width / length / height, incl. TS 7.5	5 mm / 71 mm / 48 mm
Wire strip length	10 mm
Approvals	

TECHNICAL DATA

IEC	UL	CSA
EN 60947-7-1		
Cross section fine-stranded	0.13 – 1.5 mm ²	
Cross section solid/stranded	0.13 – 1.5 mm ²	
Cross section, AWG	22 – 16	28 – 16
Rated current	10 A	10 A
Rated voltage	*	65 V
Rated impulse voltage	65 V	
Pollution degree		

ACCESSORIES

Type	Part No.	Std. Pack
Wire entry guide	0.13 – 0.2 mm ² LEL 1,5/1 WEISS	05.562.2453.0 100
	0.25 – 0.5 mm ² LEL 1,5/2 Grins	05.562.2553.0 100
	0.75 – 1.0 mm ² LEL 1,5/3 SCHWARZ	05.562.2653.0 100
Screwdriver, uninsulated	DIN 5264 B 0,6x3,5	06.502.4000.0 5

More accessories page 130 ff.

WKF 1,5 KOE...

- Supply block with tension spring connection for mounting on TS 35
- Nominal cross section 1.5 mm²



37.702.7753.0
* 65 V/1.5 kV/3

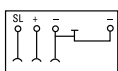

37.702.8753.0
* DC 24 V
same as picture,
but with LED

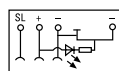

Description	Type	Part No.	Std. Pack
Supply block	black WKF 1,5 KOE	37.702.7753.0	50
Supply block with LED	black WKF 1,5 KOE-PGN	37.702.8753.0	50

GENERAL DATA

Width / length / height, incl. TS 7.5	5 mm / 71 mm / 48 mm		
Wire strip length	10 mm		
Approvals			
TECHNICAL DATA			
	IEC	UL	CSA
	EN 60947-7-1		
Cross section fine-stranded	0.13 – 1.5 mm ²		
Cross section solid/stranded	0.13 – 1.5 mm ²		
Cross section, AWG		22 – 16	28 – 18
Rated current	10 A	10 A	10 A
Rated voltage	*	65 V	65 V
Rated impulse voltage			
Pollution degree			

ACCESSORIES

	Type	Part No.	Std. Pack
Wire entry guide	0.13 – 0.2 mm ²	LEL 1,5/1 WEISS	05.562.2453.0
	0.25 – 0.5 mm ²	LEL 1,5/2 Grins	05.562.2553.0
	0.75 – 1.0 mm ²	LEL 1,5/3 SCHWARZ	05.562.2653.0
Screwdriver, uninsulated	DIN 5264 B 0,6x3,5	06.502.4000.0	5

WKF 1,5 KOA 2L...

- Actuator block with tension spring connection for mounting on TS 35
- Nominal cross section 1.5 mm²

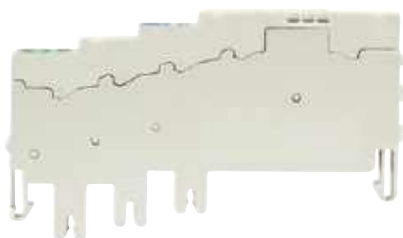

37.702.7653.0
* 65 V/1.5 kV/3

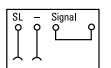

37.702.8653.0
* DC 24 V
same as picture,
but with LED

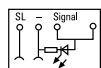

Description	Type	Part No.	Std. Pack
Actuator block	gray WKF 1,5 KOA 2L	37.702.7653.0	50
Actuator block with LED	gray WKF 1,5 KOA 2L/SL-PGE	37.702.8653.0	50

GENERAL DATA

Width / length / height, incl. TS 7.5	5 mm / 71 mm / 48 mm		
Wire strip length	10 mm		
Approvals			
TECHNICAL DATA			
	IEC	UL	CSA
	EN 60947-7-1		
Cross section fine-stranded	0.13 – 1.5 mm ²		
Cross section solid/stranded	0.13 – 1.5 mm ²		
Cross section, AWG		28 – 16	
Rated current	10 A	10 A	
Rated voltage	*	65 V	
Rated impulse voltage			
Pollution degree			

ACCESSORIES

	Type	Part No.	Std. Pack
Wire entry guide	0.13 – 0.2 mm ²	LEL 1,5/1 WEISS	05.562.2453.0
	0.25 – 0.5 mm ²	LEL 1,5/2 Grins	05.562.2553.0
	0.75 – 1.0 mm ²	LEL 1,5/3 SCHWARZ	05.562.2653.0
Screwdriver, uninsulated	DIN 5264 B 0,6x3,5	06.502.4000.0	5

VM WKF ...

- Connection module for 9 or 18 blocks



Description	Type	Part No.	Std. Pack
Connection module for 9 blocks	black VM WKF KO..9	69.700.0953.0	10
Connection module for 18 blocks	black VM WKF KO..18	69.700.1853.0	5

GENERAL DATA

Length: 9-pole module	L = 9 x 5 mm + 1.5 mm		
Length: 18-pole module	L = 18 x 5 mm + 1.5 mm		
Approvals			
TECHNICAL DATA			
	IEC	UL	
	EN 60947-7-1		
Cross section fine-stranded	0.13 – 1.5 mm ²		
Cross section solid/stranded	0.13 – 1.5 mm ²		
Cross section, AWG			
Rated current	10 A	10 A	
Rated voltage	*	65 V	
Rated impulse voltage			
Pollution degree			

FASIS MINI – DIN RAIL TERMINAL BLOCKS WITH TENSION SPRING CONNECTION

With our DIN rail terminal block system fasis MINI we focus on the application's size and flexibility. fasis MINI is a range of DIN rail terminal blocks in tension spring technology designed for installation in confined spaces.

The potential in the WKFM 2,5 terminal block series can be distributed, modified and extended quickly, flexibly and without problem by using cross connectors.



APPLICATION SPECIFIC OPTIONS

- Push-in mounting pin for installation directly onto the panel
- Screw flange for installation directly onto the panel
- Installation on TS 15 or TS 35 mounting rails



SOLUTIONS FOR CONFINED SPACES

- Space-saving miniature terminal blocks in many designs for installation inside distribution boxes, motors and applications with confined space requirements
- Easy wiring with user-friendly screwdriver entry guides at the top of the block
- Marking tags easily readable even with the wires connected
- Customized assembly design and marking using wieplot



PERMANENT ELECTRICAL CONNECTION

- The tension spring system provides a dynamic clamping connection. Load-controlled and thermal cold flow properties of the connected wires are balanced
- Maintenance-free and gas-tight electrical connection as specified by the approvals. Customized layouts can be created individually
- Separation of electrical and mechanical functions



CUSTOMIZED ASSEMBLY



- DIN rail terminal blocks of the fasis MINI series are available in 2 and 4-pole configurations
- fasis MINI blocks can be snapped together with the integrated latching pins, with or without a mounting rail
- The various potentials and terminal blocks are visually distinguished by several color variations
- Individual marking using marking tags or customized printing of the terminal blocks

WKMF 2,5/15

- Feed-through block with tension spring connection for mounting on TS 15
- Nominal cross section 2.5 mm²
- Ex e II  II 2GD
Follow the EX installation instructions on page 160



Description	Type	Part No.	Std. Pack
Feed-through block	gray WKMF 2,5/15	55.703.0053.0	100
Feed-through block	blue WKMF 2,5/15	55.703.0053.6	100

GENERAL DATA				
Width / length / height, incl. TS 5.5	5 mm / 36 mm / 30 mm			
Wire strip length	10 mm			
Approvals	ATEX  		KEMA 03 ATEX 2071 U	
TECHNICAL DATA				
	IEC	UL	CSA	
	EN 60 947-7-1			
Cross section fine-stranded	0.13–2.5 mm ²		EN 60 079-0/-7	
Cross section solid/stranded	0.13–2.5 mm ²		0.5–2.5 mm ²	
Cross section, AWG		26–12	26–12	
Rated current	24 A	20 A	20 A	19/20 A ¹⁾
Rated voltage	500 V	300 V	300 V	275 V ²⁾
Rated impulse voltage	6 kV			
Pollution degree	3			

Note

¹⁾ with/without jumper



²⁾ For maintaining the proper isolation distances, the open side of feed-through or ground blocks as well as both sides of a jumper are to be covered by partitions.

WKMF 2,5 SL/15

- Ground block with tension spring connection for mounting on TS 15
- Nominal cross section 2.5 mm²
- Ex e II  II 2GD
Follow the EX installation instructions on page 160



Description	Type	Part No.	Std. Pack
Ground block	green/yellow WKMF 2,5 SL/15	55.703.9053.0	100

GENERAL DATA				
Width / length / height, incl. TS 5.5	5 mm / 36 mm / 30 mm			
Wire strip length	10 mm			
Approvals	ATEX  		KEMA 03 ATEX 2071 U	
TECHNICAL DATA				
	IEC	UL	CSA	
	EN 60 947-7-2			
Cross section fine-stranded	0.13–2.5 mm ²		EN 60 079-0/-7	
Cross section solid/stranded	0.13–2.5 mm ²		0.5–2.5 mm ²	
Cross section, AWG		26–12	26–12	
Rated current				
Rated voltage	500 V	300 V	300 V	¹⁾
Rated impulse voltage	6 kV			
Pollution degree	3			

Note

¹⁾ For maintaining the proper isolation distances, the open side of feed-through or ground blocks as well as both sides of a jumper are to be covered by partitions.

ACCESSORIES FOR FASIS WKMF 2,5



ACCESSORIES	Type	Part No.	Std. Pack
End plate, 1.5 mm wide	gray APMF 2,5 /15	07.312.5953.0	10
Cross connector, insulated	2-pole IVB WKMF 2,5–2	Z7.260.0229.0	10
	3-pole IVB WKMF 2,5–3	Z7.260.0329.0	10
	4-pole IVB WKMF 2,5–4	Z7.260.0429.0	10
	5-pole IVB WKMF 2,5–5	Z7.260.0529.0	10
	10-pole IVB WKMF 2,5–10	Z7.260.1029.0	10
	50-pole IVB WKMF 2,5 M50	Z7.260.0029.0	10
Screwdriver, uninsulated	DIN 5264 B 0,6x3,5	06.502.4000.0	5
Screwdriver, uninsulated, MINI	DIN 5264 B 0,6x3,5 M	06.502.5000.0	10

More accessories page 130 ff.

Technical information see FACTS & DATA page 158 ff.

Subject to technical modifications

FASIS MINI · MINI TERMINAL BLOCKS WITH TENSION SPRING CONNECTION

WKF 2,5/M WITH FLANGE

- Feed-through block with tension spring connection with or without flange
- Nominal cross section 2.5 mm²



WKF 2,5/M/F



WKF 2,5/M

Description	Type	Part No.	Std. Pack
Feed-through block unmarked	gray WKF 2,5/M	37.703.0553.0	100
Feed-through block unmarked	blue WKF 2,5/M BLAU	37.703.0553.6	100
Feed-through block unmarked	orange WKF 2,5/M ORANGE	37.703.0553.9	100
Feed-through block with flange	gray WKF 2,5/M/F	39.703.0153.0	100
Feed-through block with flange	blue WKF 2,5/M/F BLAU	39.703.0153.6	100
Feed-through block with flange	orange WKF 2,5/M/F ORANGE	39.703.0153.9	100

GENERAL DATA

Width / length / height	5 mm / 36 mm / 23 mm
Wire strip length	11 mm
Approvals	

TECHNICAL DATA

IEC	UL	CSA
EN 60947-7-1		
Cross section fine-stranded		
0.13 – 2.5 mm ²		
Cross section solid/stranded		
0.13 – 4 mm ²		
Cross section, AWG	22 – 12	24 – 12
Rated current	24 A	20 A
Rated voltage	800 V	600 V
Rated impulse voltage	8 kV	600 V
Pollution degree	3	3

WKF 2,5/MD WITH FLANGE

- Duo feed-through block with tension spring connection with or without flange
- Nominal cross section 2.5 mm²



WKF 2,5/MD/F



WKF 2,5/MD

Description	Type	Part No.	Std. Pack
Duo feed-through block unmarked	gray WKF 2,5/MD	37.703.1053.0	100
Duo feed-through block unmarked	blue WKF 2,5/MD BLAU	37.703.1053.6	100
Duo feed-through block unmarked	orange WKF 2,5/MD ORANGE	37.703.1053.9	100
Duo feed-through block with flange	gray WKF 2,5/MD/F	39.703.0253.0	100
Duo feed-through block with flange	blue WKF 2,5/MD/F BLAU	39.703.0253.6	100
Duo feed-through block with flange	orange WKF 2,5/MD/F ORANGE	39.703.0253.9	100

GENERAL DATA

Width / length / height	10 mm / 36 mm / 23 mm
Wire strip length	11 mm
Approvals	

TECHNICAL DATA

IEC	UL	CSA
EN 60947-7-1		
Cross section fine-stranded		
0.13 – 2.5 mm ²		
Cross section solid/stranded		
0.13 – 4 mm ²		
Cross section, AWG	22 – 12	24 – 12
Rated current	24 A	20 A
Rated voltage	800 V	600 V
Rated impulse voltage	8 kV	600 V
Pollution degree	3	3

ACCESSORIES FOR FASIS WKF 2,5/M

ACCESSORIES	Type	Part No.	Std. Pack
End plate with flange on the right	gray APF 2,5/M.../F/R	07.312.3153.0	10
End plate with flange on the right	blue APF 2,5/M.../F/R BLAU	07.312.3153.6	10
End plate with flange on the right	orange APF 2,5/M.../F/R ORANGE	07.312.3153.9	10
Wire entry guide	0.13 – 0.2 mm ² LEL 2,5/1 WEISS	05.561.6553.0	100
Wire entry guide	0.25 – 0.5 mm ² LEL 2,5/2 Grins	05.561.6653.0	100
Wire entry guide	0.75 – 1.0 mm ² LEL 2,5/3 SCHWARZ	05.561.6753.0	100
Cross connector, insulated	2-pole	05.902.3500.0	10
Marking strip, unmarked	(4 x 22 pcs.)	04.244.0053.0	5
marked	(1 – 11)	04.844.2053.0	5
marked	(12 – 55)	04.844.2153.0	5
marked	(56 – 99)	04.844.2253.0	5
Screwdriver, uninsulated	DIN 5264 B 0,6 x 3,5	06.502.4000.0	5

More accessories page 130 ff.

WKF 2,5/M/R WITH MOUNTING FOOT

- Feed-through block with tension spring connection, unmarked
- Nominal cross section 2.5 mm²



Mounting hole: Ø 3,5 mm
Plate thickness: 0,6 – 1,2 mm

Description	Type	Part No.	Std. Pack
Feed-through block unmarked	gray WKF 2,5/M/R	38.703.0553.0	100
Feed-through block unmarked	blue WKF 2,5/M/R BLAU	38.703.0553.6	100
Feed-through block unmarked	orange WKF 2,5/M/R ORANGE	38.703.0553.9	100

GENERAL DATA				
Width / length / height	5 mm / 36 mm / 23 mm			
Wire strip length	11 mm			
Approvals				
TECHNICAL DATA		IEC	UL	CSA
		EN 60947-7-1		
Cross section fine-stranded	0.13 – 2.5 mm ²			
Cross section solid/stranded	0.13 – 4 mm ²			
Cross section, AWG		22 – 12	24 – 12	
Rated current	24 A	20 A	25 A	
Rated voltage	800 V	600 V	600 V	
Rated impulse voltage	8 kV			
Pollution degree	3			

WKF 2,5/MD/R WITH MOUNTING FOOT

- Duo feed-through block with tension spring connection, unmarked
- Nominal cross section 2.5 mm²



Mounting hole: Ø 3,5 mm
Plate thickness: 0,6 – 1,2 mm

Description	Type	Part No.	Std. Pack
Duo feed-through block unmarked	gray WKF 2,5/MD/R	38.703.1053.0	100
Duo feed-through block unmarked	blue WKF 2,5/MD/R BLAU	38.703.1053.6	100
Duo feed-through block unmarked	orange WKF 2,5/MD/R ORANGE	38.703.1053.9	100

GENERAL DATA				
Width / length / height	10 mm / 36 mm / 23 mm			
Wire strip length	11 mm			
Approvals				
TECHNICAL DATA		IEC	UL	CSA
		EN 60947-7-1		
Cross section fine-stranded	0.13 – 2.5 mm ²			
Cross section solid/stranded	0.13 – 4 mm ²			
Cross section, AWG		22 – 12	24 – 12	
Rated current	24 A	20 A	25 A	
Rated voltage	800 V	600 V	600 V	
Rated impulse voltage	8 kV			
Pollution degree	3			

ACCESSORIES FOR FASIS WKF 2,5/M/R

ACCESSORIES	Type	Part No.	Std. Pack
End plate	gray APF 2,5/M...	07.312.2953.0	10
End plate	blue APF 2,5/M... BLAU	07.312.2953.6	10
End plate	orange APF 2,5/M... ORANGE	07.312.2953.9	10
Wire entry guide	0.13 – 0.2 mm ² LEL 2,5/1 WEISS	05.561.6553.0	100
Wire entry guide	0.25 – 0.5 mm ² LEL 2,5/2 Grins	05.561.6653.0	100
Wire entry guide	0.75 – 1.0 mm ² LEL 2,5/3 SCHWARZ	05.561.6753.0	100
Cross connector, insulated	2-pole	05.902.3500.0	10
Marking strip, unmarked	(4 x 22 pcs.)	04.244.0053.0	5
marked	(1 – 11)	04.844.2053.0	5
marked	(12 – 55)	04.844.2153.0	5
marked	(56 – 99)	04.844.2253.0	5
Screwdriver, uninsulated	DIN 5264 B 0,6 x 3,5	06.502.4000.0	5

FASIS MINI · MINI TERMINAL BLOCKS WITH TENSION SPRING CONNECTION

WKF 2,5/M/15

- Feed-through block with tension spring connection, unmarked, for mounting on TS 15
- Nominal cross section 2.5 mm²



Description	Type	Part No.	Std. Pack
Feed-through block unmarked	gray WKF 2,5/M/15	55.703.0553.0	100
Feed-through block unmarked	blue WKF 2,5/M/15 BLAU	55.703.0553.6	100
Feed-through block unmarked	orange WKF 2,5/M/15 ORANGE	55.703.0553.9	100
Feed-through block unmarked	green WKF 2,5/M/15 GRÜN	55.703.0553.7	100

GENERAL DATA

Width / length / height, incl. TS 5.5	5 mm / 36 mm / 27 mm
Wire strip length	11 mm
Approvals	

TECHNICAL DATA	IEC	UL	CSA
	EN 60947-7-1		
Cross section fine-stranded	0.13 – 2.5 mm ²		
Cross section solid/stranded	0.13 – 4 mm ²		
Cross section, AWG		22 – 12	24 – 12
Rated current	24 A	20 A	25 A
Rated voltage	800 V	600 V	600 V
Rated impulse voltage	8 kV		
Pollution degree	3		

WKF 2,5/MD/15

- Duo feed-through block with tension spring connection, unmarked, for mounting on TS 15
- Nominal cross section 2.5 mm²



Description	Type	Part No.	Std. Pack
Duo feed-through block unmarked	gray WKF 2,5/MD/15	55.703.1053.0	100
Duo feed-through block unmarked	blue WKF 2,5/MD/15 BLAU	55.703.1053.6	100
Duo feed-through block unmarked	orange WKF 2,5/MD/15 ORANGE	55.703.1053.9	100
Duo feed-through block unmarked	green WKF 2,5/MD/15 GRÜN	55.703.1053.7	100

GENERAL DATA

Width / length / height, incl. TS 5.5	10 mm / 36 mm / 27 mm
Wire strip length	11 mm
Approvals	

TECHNICAL DATA	IEC	UL	CSA
	EN 60947-7-1		
Cross section fine-stranded	0.13 – 2.5 mm ²		
Cross section solid/stranded	0.13 – 4 mm ²		
Cross section, AWG		22 – 12	24 – 12
Rated current	24 A	20 A	25 A
Rated voltage	800 V	600 V	600 V
Rated impulse voltage	8 kV		
Pollution degree	3		

WKF 2,5/M/35

- Feed-through block with tension spring connection, unmarked, for mounting on TS 35
- Nominal cross section 2.5 mm²



Description	Type	Part No.	Std. Pack
Feed-through block unmarked	gray WKF 2,5/M/35	56.703.0553.0	100
Feed-through block unmarked	blue WKF 2,5/M/35 BLAU	56.703.0553.6	100
Feed-through block unmarked	orange WKF 2,5/M/35 ORANGE	56.703.0553.9	100
Feed-through block unmarked	green WKF 2,5/M/35 GRÜN	56.703.0553.7	100

GENERAL DATA

Width / length / height, incl. TS 7.5	5 mm / 36 mm / 32 mm
Wire strip length	11 mm
Approvals	

TECHNICAL DATA	IEC	UL	CSA
	EN 60947-7-1		
Cross section fine-stranded	0.13 – 2.5 mm ²		
Cross section solid/stranded	0.13 – 4 mm ²		
Cross section, AWG		22 – 12	24 – 12
Rated current	24 A	20 A	25 A
Rated voltage	800 V	600 V	600 V
Rated impulse voltage	8 kV		
Pollution degree	3		

WKF 2,5/MD/35

- Duo-Feed-through block with tension spring connection, unmarked, for mounting on TS 35
- Nominal cross section 2.5 mm²



Description	Type	Part No.	Std. Pack
Duo-Feed-through block unmarked	gray WKF 2,5/MD/35	56.703.1053.0	100
Duo-Feed-through block unmarked	blue WKF 2,5/MD/35 BLAU	56.703.1053.6	100
Duo-Feed-through block unmarked	orange WKF 2,5/MD/35 ORANGE	56.703.1053.9	100
Duo-Feed-through block unmarked	green WKF 2,5/MD/35 GRÜN	56.703.1053.7	100

GENERAL DATA

Width / length / height, incl. TS 7.5	10 mm / 36 mm / 32 mm
Wire strip length	11 mm
Approvals	

TECHNICAL DATA	IEC	UL	CSA
	EN 60947-7-1		
Cross section fine-stranded	0.13 – 2.5 mm ²		
Cross section solid/stranded	0.13 – 4 mm ²		
Cross section, AWG		22 – 12	24 – 12
Rated current	24 A	20 A	25 A
Rated voltage	800 V	600 V	600 V
Rated impulse voltage	8 kV		
Pollution degree	3		

ACCESSORIES FOR FASIS WKF 2,5/M

ACCESSORIES	Type	Part No.	Std. Pack
End plate	gray APF 2,5/M...	07.312.2953.0	10
End plate	blue APF 2,5/M... BLAU	07.312.2953.6	10
End plate	orange APF 2,5/M... ORANGE	07.312.2953.9	10
Wire entry guide	0.13 – 0.2 mm ² LEL 2,5/1 WEISS	05.561.6553.0	100
Wire entry guide	0.25 – 0.5 mm ² LEL 2,5/2 Grins	05.561.6653.0	100
Wire entry guide	0.75 – 1.0 mm ² LEL 2,5/3 SCHWARZ	05.561.6753.0	100
Cross connector, insulated	2-pole	05.902.3500.0	10
Marking strip, unmarked	(4 x 22 pcs.)	04.244.0053.0	5
marked	(1 – 11)	04.844.2053.0	5
marked	(12 – 55)	04.844.2153.0	5
marked	(56 – 99)	04.844.2253.0	5
Screwdriver, uninsulated	DIN 5264 B 0,6 x 3,5	06.502.4000.0	5

FASIS BIT – DIN RAIL TERMINALS FOR INSTALLATION DISTRIBUTION BOARDS

The tension spring connection of the fasis BIT series impresses users with its maintenance-free and vibration-proof connection mechanism.

The top connection from above is especially suitable for tight spaces. The fasis BIT is designed for use in distribution systems and takes into account the standardized dimensions for small distributors and field distributors with covers in accordance with DIN 43871.



SPACE-SAVING WIRING

- Clear wiring and assignment of electrical circuits through three-story design in 5 mm assembly width
- Neutral conductor, current throughput, and green conductor connection in just one terminal
- Safety and convenience through switchable N disconnect function

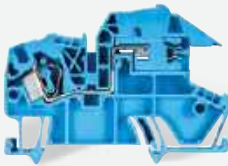

CONVENIENT SWITCHING AND OPERATION

- Screwless, maintenance-free spring-force device
- Easy conductor feed and operation from above
- Safety and operation convenience even with disconnection of the neutral conductor from the neutral busbar for insulation measurement using slide-gate valve with optical control.



COMBINABLE IN THE SYSTEM

- Problem-free combination of installation terminals with other Wieland terminal blocks, also with different connection equipment
- For example:
 - Circuit wiring with compact spring-force device fasis BIT
 - Power feed with proven selos screws
- Low storage and logistics expense due to uniform accessories



SIMPLE TESTING

- Function test with modular test adapter
- Integrated test jacks in all blocks

FASIS BIT · NEUTRAL DISCONNECT BLOCKS FOR INSTALLATION DISTRIBUTION BOARDS WITH TENSION SPRING CONNECTION

WKF 4 NT

- Neutral disconnect block with tension spring connection for mounting on TS 35
- Nominal cross section 4 mm²



Description	Type	Part No.	Std. Pack
Neutral disconnect terminal	blue WKF 4 NT / 35	56.704.8153.0	100

GENERAL DATA

Width / length / height, incl. TS 7.5	6 mm / 69.5 mm / 51.2 mm
Wire strip length	11 mm
Approvals	☰

TECHNICAL DATA

	IEC	CSA
	EN 60 947-7-1	
Cross section fine-stranded	0.14-4 mm ²	
Cross section solid/stranded	0.14-6 mm ²	
Cross-section, AWG		22-10 AWG
Rated current	25 A	
Rated voltage	400 V	600 V
Rated impulse voltage	6 kV	
Pollution degree	3	

ACCESSORIES

	Type	Part No.	Std. Pack
End plate	APF 4 NT	07.312.5653.0	10
Jumper bar	2-pole	IVBWKF 4 - 2	10
	3-pole	IVBWKF 4 - 3	10
	10-pole	IVBWKF 4 - 10	20
Busbar	9813 M SN 10X3 1000MM	98.290.1000.0	1
Connection clamp for busbar	WAK16/2 BL/V0	30.494.3021.6	100
Connection clamp for busbar	WAK35/2 BL/V0	30.494.4021.6	100
Connection clamp for busbar	WAK35/2	30.494.4121.0	50

WKF 10 NT

- Neutral disconnect block with tension spring connection for mounting on TS 35
- Nominal cross section 10 mm²
- Enclosed design

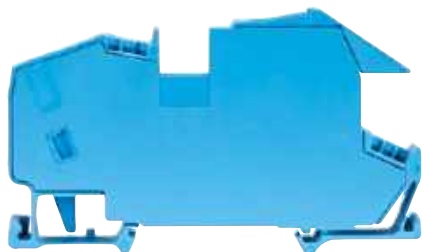

Description	Type	Part No.	Std. Pack
Neutral disconnect terminal	blue WKF 10 NT/35	56.710.8153.0	50

GENERAL DATA

Width / length / height, incl. TS 7.5	10 mm / 82 mm / 51.2 mm
Wire strip length	13 mm
Approvals	☰

TECHNICAL DATA

	IEC
	EN 60 947-7-1
Cross section fine-stranded	2.5-10 mm ²
Cross section solid/stranded	2.5-10 mm ²
Cross-section, AWG	
Rated current	57 A
Rated voltage	400 V
Rated impulse voltage	6 kV
Pollution degree	3

ACCESSORIES

	Type	Part No.	Std. Pack
Jumper bar	2-pole	IVBWKF 10- 2	10
Busbar	9813 M SN 10X3 1000MM	98.290.1000.0	1
Connection clamp for busbar	WAK16/2 BL/V0	30.494.3021.6	100
Connection clamp for busbar	WAK35/2 BL/V0	30.494.4021.6	100
Connection clamp for busbar	WAK35/2	30.494.4121.0	50

WKIF 16 NT

- Neutral disconnect block with tension spring connection for mounting on TS 35
- Nominal cross section 16 mm²
- Enclosed design



Description	Type	Part No.	Std. Pack
Neutral disconnect terminal	blue WKIF 16/1 NT/35	56.716.8155.0	20

GENERAL DATA

Width / length / height, incl. TS 7.5	12 mm / 94 mm / 51.2 mm
Wire strip length	15 mm
Approvals	☰

TECHNICAL DATA

	IEC
	EN 60 947-7-1
Cross section fine-stranded	4-16 mm ²
Cross section solid/stranded	4-16 mm ²
Cross-section, AWG	
Rated current	76 A
Rated voltage	400 V
Rated impulse voltage	6 kV
Pollution degree	3

ACCESSORIES

	Type	Part No.	Std. Pack
Jumper bar	2-pole	IVBWKF 16- 2	10
Busbar	9813 M SN 10X3 1000MM	98.290.1000.0	1
Connection clamp for busbar	WAK16/2 BL/V0	30.494.3021.6	100
Connection clamp for busbar	WAK35/2 BL/V0	30.494.4021.6	100
Connection clamp for busbar	WAK35/2	30.494.4121.0	50

More accessories page 144 ff.

Technical information see FACTS & DATA page 172 ff.

Subject to technical modifications

FASIS BIT · FEED-THROUGH BLOCKS FOR INSTALLATION DISTRIBUTION BOARDS WITH TENSION SPRING CONNECTION

WKF 2.5

- Feed-through block with tension spring connection for mounting on TS 35
- Nominal cross section 2.5 mm²
- Ex e I/II II 2GD IM2
Follow the EX installation instructions on page 160



Description	Type	Part No.	Std. Pack
Feed-through terminal	gray WKF 2,5 / 35	56.703.0053.0	100
	blue WKF 2,5 / 35 BLAU	56.703.0053.6	100
Feed-through terminal block green/yellow	WKF 2,5 SL / 35	56.703.9053.0	100
GENERAL DATA			
Width / length / height, incl. TS 7.5	5 mm / 5 mm / 42.3 mm		
Wire strip length	11 mm		
Approvals	CAN-Ex		KEMA 01 ATEX 2087 U
TECHNICAL DATA			
	IEC	UL	CSA
	EN 60 070-0/-7		
Cross section fine-stranded	0.13-2.5 mm ²		
Cross section solid/stranded	0.13-4 mm ²		
Cross-section, AWG	22-12 AWG	24-12 AWG	24-12 AWG
Rated current	24 A	20 A	20 A
Rated voltage	800 V	600 V	600 V
Rated impulse voltage	8 kV		690 V
Pollution degree	3		
ACCESSORIES			
	Type	Part No.	Std. Pack
End plate	APF 2,5 - 4	07.312.2153.0	10
Partition	TWF 2,5 - 4	07.312.2253.0	10
Jumper bar	2-pole IBWKF 2,5 - 2	Z7.280.6227.0	10
	3-pole IBWKF 2,5 - 3	Z7.280.6327.0	10
	10-pole IBWKF 2,5 - 10	Z7.280.7027.0	20

WKF 4

- Feed-through block with tension spring connection for mounting on TS 35
- Nominal cross section 4 mm²
- Ex e I/II II 2GD IM2
Follow the EX installation instructions on page 160



Description	Type	Part No.	Std. Pack
Feed-through terminal	gray WKF 4 / 35	56.704.0053.0	100
	blue WKF 4 / 35 BLAU	56.704.0053.6	100
Feed-through terminal block green/yellow	WKF 4 SL / 35/V0	56.704.9053.0	100
GENERAL DATA			
Width / length / height, incl. TS 7.5	6 mm / 57 mm / 42.3 mm		
Wire strip length	11 mm		
Approvals	CAN-Ex		KEMA 01 ATEX 2087 U
TECHNICAL DATA			
	IEC	UL	CSA
	EN 60 070-0/-7		
Cross section fine-stranded	0.13-4 mm ²		
Cross section solid/stranded	0.13 - 6 mm ²		
Cross-section, AWG	22-10 AWG	22-10 AWG	22-10 AWG
Rated current	32 A	20 A	20 A
Rated voltage	800 V	600 V	600 V
Rated impulse voltage	8 kV		690 V
Pollution degree	3		
ACCESSORIES			
	Type	Part No.	Std. Pack
End plate	APF 2,5 - 4	07.312.2153.0	10
Partition	TWF 2,5 - 4	07.312.2253.0	10
Jumper bar	2-pole IBWKF 4 - 2	Z7.261.1227.0	10
	3-pole IBWKF 4 - 3	Z7.261.1327.0	10
	10-pole IBWKF 4 - 10	Z7.261.2027.0	20

WKF 6

- Feed-through block with tension spring connection for mounting on TS 35
- Nominal cross section 6 mm²
- Enclosed design
- Ex e I/II II 2GD IM2
Follow the EX installation instructions on page 160

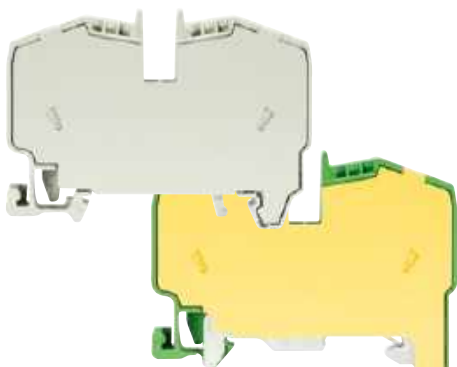



Description	Type	Part No.	Std. Pack
Feed-through terminal	gray WKF 6/35	56.706.0053.0	100
	blue WKF 6/35 BLAU	56.706.0053.6	100
Feed-through terminal block green/yellow	WKF 6SL/35	56.706.9053.0	100
GENERAL DATA			
Width / length / height, incl. TS 7.5	8 mm / 61 mm / 45.1 mm		
Wire strip length	12 mm		
Approvals	CAN-Ex		KEMA 01 ATEX 2087 U
TECHNICAL DATA			
	IEC	UL	CSA
	EN 60 0790/-7		
Cross section fine-stranded	0.5 - 6 mm ²		
Cross section solid/stranded	0.5 - 6 mm ²		
Cross-section, AWG	20-10 AWG	20-10 AWG	20-10 AWG
Rated current	41 A	40 A	40 A
Rated voltage	800 V	600 V	600 V
Rated impulse voltage	8 kV		690 V
Pollution degree	3		
ACCESSORIES			
	Type	Part No.	Std. Pack
Jumper bar	2-pole IBWKF 6- 2	Z7.282.4227.0	10

WKF 10

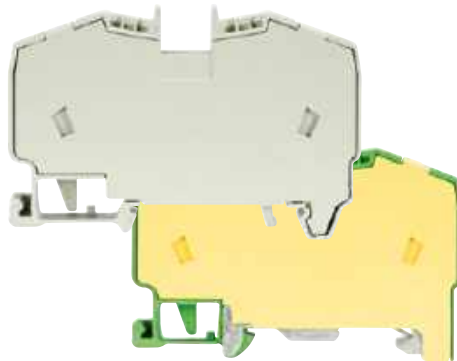
- Feed-through block with tension spring connection for mounting on TS 35
- Nominal cross section 10 mm²
- Enclosed design
- Ex e I/II  II 2GD IM2
Follow the EX installation instructions on page 160



Description	Type	Part No.	Std. Pack
Feed-through terminal	gray WKF 10/35	56.710.0053.0	50
	blue WKF 10/35 BLAU	56.710.0053.6	50
Feed-through terminal block green/yellow	WKF 10SL/35	56.710.9053.0	50

GENERAL DATA				
Width / length / height, incl. TS 7.5	10 mm / 70 mm / 47.5 mm			
Wire strip length	13 mm			
Approvals	  CAN-Ex	KEMA 01 ATEX 2087 U		

TECHNICAL DATA	IEC	UL	CSA	
	EN 60 947-7-1			EN 60 070-0/-7
Cross section fine-stranded	2.5-10 mm ²			
Cross section solid/stranded	2.5-10 mm ²			
Cross-section, AWG		14-8 AWG	14-8 AWG	
Rated current	57 A	55 A	55 A	54 A
Rated voltage	800 V	600 V	600 V	690 V
Rated impulse voltage	8 kV			
Pollution degree	3			

ACCESSORIES	Type	Part No.	Std. Pack	
Jumper bar	2-pole	IVBWK 10- 2	Z7.283.8227.0	10

WKIF 16

- Feed-through block with tension spring connection for mounting on TS 35
- Nominal cross section 16 mm²
- Enclosed design



Description	Type	Part No.	Std. Pack
Feed-through terminal	gray WKIF 16/1 /35	56.716.1155.0	20
	blue WKIF 16/1 /35 BLAU	56.716.1155.6	20
Feed-through terminal block green/yellow	WKIF 16/1 SL/35	56.716.9155.0	20

GENERAL DATA	
Width / length / height, incl. TS 7.5	12 mm / 94 mm / 47.7 mm
Wire strip length	16 mm
Approvals	

TECHNICAL DATA	IEC
	EN 60 947-7-1
Cross section fine-stranded	4-16 mm ²
Cross section solid/stranded	4-16 mm ²
Cross-section, AWG	
Rated current	76 A
Rated voltage	800 V
Rated impulse voltage	8 kV
Pollution degree	3

ACCESSORIES	Type	Part No.	Std. Pack	
Jumper bar	2-pole	IVBWK 16- 2	Z7.284.4227.0	10

WKF 16

- Feed-through block with tension spring connection for mounting on TS 35
- Nominal cross section 16 mm²
- Enclosed design
- Ex e I/II  II 2GD IM2
Follow the EX installation instructions on page 160

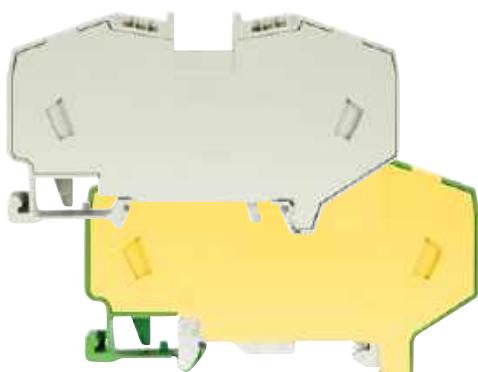

Description	Type	Part No.	Std. Pack
Feed-through terminal	gray WKF 16/35	56.716.0053.0	50
	blue WKF 16/35 BLAU	56.716.0053.6	50
Feed-through terminal block green/yellow	WKF 16SL/35	56.716.9053.0	50

GENERAL DATA				
Width / length / height, incl. TS 7.5	12 mm / 82 mm / 47.7 mm			
Wire strip length	15 mm			
Approvals	  CAN-Ex	KEMA 01 ATEX 2087 U		

TECHNICAL DATA	IEC	UL	CSA	
	EN 60 947-7-1			EN 60 079-0/-7
Cross section fine-stranded	4-16 mm ²			
Cross section solid/stranded	4-16 mm ²			
Cross-section, AWG		24-4 AWG	12-4 AWG	
Rated current	76 A	75 A	75 A	69 A
Rated voltage	800 V	600 V	600 V	690 V
Rated impulse voltage	8 kV			
Pollution degree	3			

ACCESSORIES	Type	Part No.	Std. Pack	
Jumper bar	2-pole	IVBWK 16- 2	Z7.284.4227.0	10

Technical information see FACTS & DATA page 158 ff.

Subject to technical modifications

FASIS BIT · MULTI-TIER TERMINALS FOR INSTALLATION DISTRIBUTION BOARDS WITH TENSION SPRING CONNECTION

WKIF 2.5 D

- Installation multi-tier terminal with tension spring connection for mounting on TS 35
- Nominal cross section 2.5 mm²



Description	Type	Part No.	Std. Pack
Installation rail terminal blocks	WKIF 2,5 D	56.703.9653.0	50

GENERAL DATA

Width / length / height, incl. TS 7.5	5 mm / 95 mm / 51.2 mm
Wire strip length	11 mm
Approvals	CE, TÜV

TECHNICAL DATA

	IEC	UL	CSA
	EN 60 947-7-1		
Cross section fine-stranded	0.14-2.5 mm ²		
Cross section solid/stranded	0.14-4 mm ²		
Cross-section, AWG		22-12 AWG	22-14 AWG
Rated current	24 A	20 A	20 A
Rated voltage	400 V		
Rated impulse voltage	6 kV		
Pollution degree	3		

ACCESSORIES

	Type	Part No.	Std. Pack
End plate	APIF 2,5	07.311.8353.0	10
Jumper bar	2-pole	IVBWK 2,5 - 2	10
	3-pole	IVBWK 2,5 - 3	10
	4-pole	IVBWK 2,5 - 4	10
	5-pole	IVBWK 2,5 - 5	10
	10-pole	IVBWK 2,5 - 10	20
Busbar	9813 M SN 10X3 1000MM	98.290.1000.0	1

WKIF 2.5 D-D

WKIF 2,5 N-D

- Installation multi-tier terminal with tension spring connection for mounting on TS 35
- Nominal cross section 2.5 mm²



Description	Type	Part No.	Std. Pack
Installation rail terminal blocks	WKIF 2,5 D-D	56.703.9753.0	50
	WKIF 2,5 N-D	56.703.9953.0	50

GENERAL DATA

Width / length / height, incl. TS 7.5	5 mm / 95 mm / 51.2 mm
Wire strip length	11 mm
Approvals	CE, TÜV

TECHNICAL DATA

	IEC	UL	CSA
	EN 60 947-7-1		
Cross section fine-stranded	0.14-2.5 mm ²		
Cross section solid/stranded	0.14-4 mm ²		
Cross-section, AWG		22-12 AWG	22-14 AWG
Rated current	24 A	20 A	20 A
Rated voltage	400 V		
Rated impulse voltage	4 kV		
Pollution degree	3		

ACCESSORIES

	Type	Part No.	Std. Pack
End plate	APIF 2,5	07.311.8353.0	10
Jumper bar	2-pole	IVBWK 2,5 - 2	10
	3-pole	IVBWK 2,5 - 3	10
	5-pole	IVBWK 2,5 - 5	10
	10-pole	IVBWK 2,5 - 10	20
Busbar	9813 M SN 10X3 1000MM	98.290.1000.0	1

WKIF 2.5 D-D-SL

WKIF 2.5 N-D-SL

- Installation multi-tier terminal with tension spring connection for mounting on TS 35
- Nominal cross section 2.5 mm²



Description	Type	Part No.	Std. Pack
Installation rail terminal blocks	WKIF 2,5 D-D-SL	56.703.9853.0	50
	WKIF 2,5 N-D-SL	56.703.9453.0	50

GENERAL DATA

Width / length / height, incl. TS 7.5	5 mm / 95 mm / 51.2 mm
Wire strip length	11 mm
Approvals	CE, TÜV

TECHNICAL DATA

	IEC	UL	CSA
	EN 60 947-7-1		
Cross section fine-stranded	0.14-2.5 mm ²		
Cross section solid/stranded	0.14-4 mm ²		
Cross-section, AWG		22-12 AWG	22-14 AWG
Rated current	24 A	20 A	20 A
Rated voltage	400 V		
Rated impulse voltage	4 kV		
Pollution degree	3		

ACCESSORIES

	Type	Part No.	Std. Pack
End plate	APIF 2,5	07.311.8353.0	10
Jumper bar	2-pole	IVBWK 2,5 - 2	10
	3-pole	IVBWK 2,5 - 3	10
	10-pole	IVBWK 2,5 - 10	20
Busbar	9813 M SN 10X3 1000MM	98.290.1000.0	1

More accessories page 130 ff.

WKIF 2.5 NT-D-SL

- Installation multi-tier terminal with tension spring connection for mounting on TS 35
- Nominal cross section 2.5 mm²



Description	Type	Part No.	Std. Pack
Installation rail terminal blocks	WKIF 2,5 NT-D-SL	56.703.9553.0	50

GENERAL DATA

Width / length / height, incl. TS 7.5	5 mm / 95 mm / 51.2 mm
Wire strip length	11 mm
Approvals	

TECHNICAL DATA	IEC	UL	CSA
	EN 60 947-7-1		
Cross section fine-stranded	0.14-2.5 mm ²		
Cross section solid/stranded	0.14-4 mm ²		
Cross-section, AWG		22-12 AWG	22-14 AWG
Rated current	20 A	20 A	20 A
Rated voltage	400 V		300 V
Rated impulse voltage	6 kV		
Pollution degree	3		

ACCESSORIES	Type	Part No.	Std. Pack
End plate	APIF 2,5	07.311.8353.0	10
Jumper bar	2-pole IVBWK 2,5 - 2	Z7.280.6227.0	10
	3-pole IVBWK 2,5 - 3	Z7.280.6327.0	10
	4-pole IVBWK 2,5 - 4	Z7.280.6427.0	10
	5-pole IVBWK 2,5 - 5	Z7.280.6527.0	10
	10-pole IVBWK 2,5 - 10	Z7.280.7027.0	20
Busbar	9813 M SN 10X3 1000MM	98.290.1000.0	1

WKIF 2.5 NTM-D-SL

- Installation multi-tier terminal with cutting knife connection for mounting on TS 35
- Nominal cross section 2.5 mm²

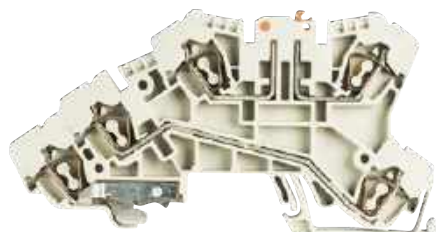

Description	Type	Part No.	Std. Pack
Installation terminal with cutting knife	WKIF 2,5 NTM-D-SL	56.703.8653.0	50
Installation terminal, same construction without cutting knife	WKIF 2,5 NTM-D-SL	on request	50

GENERAL DATA

Width / length / height, incl. TS 7.5	5 mm / 95 mm / 51.2 mm
Wire strip length	11 mm
Approvals	

TECHNICAL DATA	IEC
	EN 60 947-7-1
Cross section fine-stranded	0.14-2.5 mm ²
Cross section solid/stranded	0.14-4 mm ²
Cross-section, AWG	
Rated current	16 A
Rated voltage	400 V
Rated impulse voltage	6 kV
Pollution degree	3

ACCESSORIES	Type	Part No.	Std. Pack
End plate	APIF 2,5 TM	07.312.8053.0	10
Jumper bar	2-pole IVBWK 2,5 - 2	Z7.280.6227.0	10
	3-pole IVBWK 2,5 - 3	Z7.280.6327.0	10
	4-pole IVBWK 2,5 - 4	Z7.280.6427.0	10
	5-pole IVBWK 2,5 - 5	Z7.280.6527.0	10
	10-pole IVBWK 2,5 - 10	Z7.280.7027.0	20

FASIS WTP – DIN RAIL TERMINAL BLOCKS WITH PUSH-IN CONNECTION

Terminate wires easily, directly and without tools! fasisWTP – DIN rail terminal blocks with push-in connection. Built according to an effective and comprehensive concept, including compact design and high-performance contact technology, fasisWTP reduces installation time and keeps inventory costs to a minimum.

fasisWTP has been designed for use in machinery and plant engineering, as well as power distribution for buildings.



- + Includes feed-through and ground blocks with 2, 3 or 4 termination points
- + Multi-tier terminals
- + Solutions for initiators and actuators



PERFORMANCE FEATURES

- + Connection cross-section: up to 10 mm²
- + Rated current: up to 57 A
- + Rated voltage: up to 1000 V

FASIS WTP – TERMINALS WITH PUSH-IN CONNECTION **SAVE TIME + MONEY**

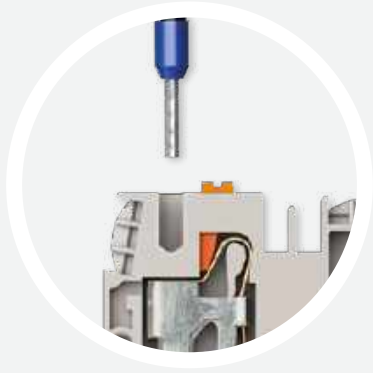

Simply plug in wires

- Connect quickly without any tools
- With smart push-in connection
- Connect wires directly

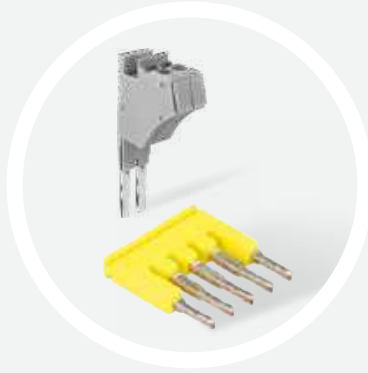

Completing the Concept

- Dual jumpering channel
- Plug-in jumper bars
- Plug-in test adapter

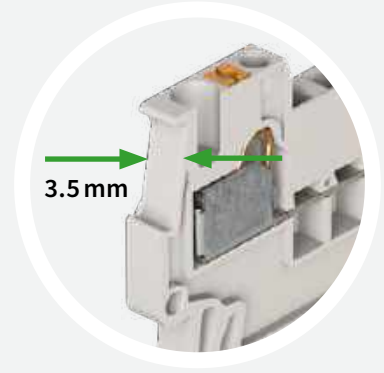

Space-saving

- High packing density
- Assembly width only 3.5 mm

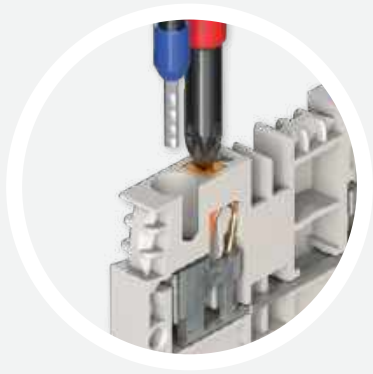

Safe handling

- With integrated release lever
- No mix-up of wire entry and screwdriver entry points
- No contact with live parts
- Use of Phillips screwdriver also possible

FEATURES

- + Connect your control cabinet quickly without losing time
- + Save space in the control cabinet
- + Reduce your logistics overhead



FASIS WTP TERMINALS OVERVIEW



FASIS WTP 1.5 FOR SIGNAL WIRING

Feed-through and PE terminal blocks

- Efficient use of space in control cabinet

Multi-tier terminals

- Only 1.75 mm / signal pass!



FASIS WTP 1.5 FOR INITIATOR / ACTUATOR WIRING

Connection solutions for 3-wire and 4-wire sensors and actuators

- Powerful feeder terminal
- Various applications (control cabinet, distributors)
- Efficient use of space in control cabinet



FASIS WTP 2.5/4 FOR UNIVERSAL APPLICATIONS

Feed-through and PE terminal blocks

Multi-tier terminals

- Cost-saving for warehousing & logistics
- 2.5 and 4 mm² in a terminal with assembly width of only 5 mm
- Uniform and universal accessories



FASIS WTP 6/10 FOR ENERGY DISTRIBUTION

Feed-through and PE terminal blocks

Multi-conductor terminals

- Powerful – up to 10 mm² and 57 A
- Assembly width of only 8 mm

FASIS WTP · FEED-THROUGH TERMINALS WITH PUSH-IN CONNECTION

WTP 1,5

- Feed-through terminal with push-in connection for mounting on mounting rail (MR) 35
- Nominal cross-section 1.5 mm²
- Assembly width of 3.5 mm



Description	Type	Part No.	Std. Pack	
Feed-through terminal	gray WTP 1,5	56.202.0055.0	100	
Feed-through terminal	blue WTP 1,5 BLAU	56.202.0055.6	100	
GENERAL DATA				
Width / length / height, incl. MR 7.5	3.5 mm / 46 mm / 32 mm			
Wire strip length	8 mm			
Certificates / Approvals				
TECHNICAL DATA		IEC	UL	CSA
		EN 60 947-7-1		
Cross-section fine-stranded	0.14 - 1.5 mm ²			
Cross-section solid/stranded	0.14 - 2.5 mm ²			
Cross-section, AWG	26-14		26-14	
Rated current	17.5 A	15 A	15 A	
Rated voltage	500 V	300 V	300 V	
Rated impulse voltage	6 kV			
Pollution degree	3			
ACCESSORIES		Type	Part No.	Std. Pack
End plate		AP WTP 1,5	07.313.4455.0	10
Partition		TW WTP 1,5	07.313.4955.0	10

WTP 1,5 D1/2

- Duo feed-through terminal with push-in connection for mounting on MR 35
- Nominal cross-section 1.5 mm²
- Assembly width of 3.5 mm



Description	Type	Part No.	Std. Pack	
Feed-through terminal	gray WTP 1,5 D1/2	56.202.5055.0	100	
Feed-through terminal	blue WTP 1,5 D1/2 BLAU	56.202.5055.6	100	
GENERAL DATA				
Width / length / height, incl. MR 7.5	3.5 mm / 55 mm / 32 mm			
Wire strip length	8 mm			
Certificates / Approvals				
TECHNICAL DATA		IEC	UL	CSA
		EN 60 947-7-1		
Cross-section fine-stranded	0.14 - 1.5 mm ²			
Cross-section solid/stranded	0.14 - 2.5 mm ²			
Cross-section, AWG	26-14		26-14	
Rated current	17.5 A	15 A	15 A	
Rated voltage	500 V	300 V	300 V	
Rated impulse voltage	6 kV			
Pollution degree	3			
ACCESSORIES		Type	Part No.	Std. Pack
End plate		AP WTP 1,5 D1/2	07.313.4555.0	10
Partition		TW WTP 1,5 D/E	07.313.5555.0	10

WTP 1,5 D2/2

- Duo feed-through terminal with push-in connection for mounting on MR 35
- Nominal cross-section 1.5 mm²
- Assembly width of 3.5 mm



Description	Type	Part No.	Std. Pack	
Feed-through terminal	gray WTP 1,5 D2/2	56.202.5155.0	100	
Feed-through terminal	blue WTP 1,5 D2/2 BLAU	56.202.5155.6	100	
GENERAL DATA				
Width / length / height, incl. MR 7.5	3.5 mm / 64 mm / 32 mm			
Wire strip length	8 mm			
Certificates / Approvals				
TECHNICAL DATA		IEC	UL	CSA
		EN 60 947-7-1		
Cross-section fine-stranded	0.14 - 1.5 mm ²			
Cross-section solid/stranded	0.14 - 2.5 mm ²			
Cross-section, AWG	26-14		26-14	
Rated current	17.5 A	15 A	15 A	
Rated voltage	500 V	300 V	300 V	
Rated impulse voltage	6 kV			
Pollution degree	3			
ACCESSORIES		Type	Part No.	Std. Pack
End plate		AP WTP 1,5 D2/2	07.313.4655.0	10
Partition		TW WTP 1,5 D/E	07.313.5555.0	10

ACCESSORIES FOR FASIS WTP 1.5



ACCESSORIES	Type	Part No.	Std. Pack
Jumper bar	2-pole	IVB WTP 1,5-2	Z7.284.7027.0
	3-pole	IVB WTP 1,5-3	Z7.284.7127.0
	4-pole	IVB WTP 1,5-4	Z7.284.7227.0
	5-pole	IVB WTP 1,5-5	Z7.284.7327.0
	10-pole	IVB WTP 1,5-10	Z7.284.7427.0
Warning cover	AD WTP 1,5	04.344.2655.0	10
Screwdriver	DIN 5264 B 0,4 X 2,5	06.502.4300.0	5
Marking accessories, see P. 140			

FASIS WTP · GROUND TERMINALS WITH PUSH-IN CONNECTION

WTP 1,5 PE

- Ground terminal with push-in connection for mounting on MR 35
- Nominal cross-section 1.5 mm²
- Assembly width of 3.5 mm



Description	Type	Part No.	Std. Pack
Ground terminal	green/yellow WTP 1,5 PE	56.202.9055.0	100
GENERAL DATA			
Width / length / height, incl. MR 7.5	3.5 mm / 46 mm / 32 mm		
Wire strip length	8 mm		
Certificates / Approvals			
TECHNICAL DATA	IEC	UL	CSA
	EN 60 947-7-2		
Cross-section fine-stranded	0.14 – 1.5 mm ²		
Cross-section solid/stranded	0.14 – 2.5 mm ²		
Cross-section, AWG		26–14	26–14
Rated voltage	500 V	300 V	300 V
Rated impulse voltage	6 kV		
Pollution degree	3		
ACCESSORIES	Type	Part No.	Std. Pack
End plate	gray AP WTP 1,5	07.313.4455.0	10
Partition	gray TW WTP 1,5	07.313.4955.0	10

WTP 1,5 D1/2 PE

- Duo ground terminal with push-in connection for mounting on MR 35
- Nominal cross-section 1.5 mm²
- Assembly width of 3.5 mm

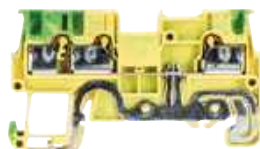

Description	Type	Part No.	Std. Pack
Ground terminal	green/yellow WTP 1,5 D1/2 PE	56.202.9355.0	100
GENERAL DATA			
Width / length / height, incl. MR 7.5	3.5 mm / 55 mm / 32 mm		
Wire strip length	8 mm		
Certificates / Approvals			
TECHNICAL DATA	IEC	UL	CSA
	EN 60 947-7-2		
Cross-section fine-stranded	0.14 – 1.5 mm ²		
Cross-section solid/stranded	0.14 – 2.5 mm ²		
Cross-section, AWG		26–14	26–14
Rated voltage	500 V	300 V	300 V
Rated impulse voltage	6 kV		
Pollution degree	3		
ACCESSORIES	Type	Part No.	Std. Pack
End plate	AP WTP 1,5 D1/2	07.313.4555.0	10
Partition	TW WTP 1,5 D/E	07.313.5555.0	10

WTP 1,5 D2/2 PE

- Duo ground terminal with push-in connection for mounting on MR 35
- Nominal cross-section 1.5 mm²
- Assembly width of 3.5 mm



Description	Type	Part No.	Std. Pack
Ground terminal	green/yellow WTP 1,5 D2/2 PE	56.202.9155.0	100
GENERAL DATA			
Width / length / height, incl. MR 7.5	3.5 mm / 64 mm / 32 mm		
Wire strip length	8 mm		
Certificates / Approvals			
TECHNICAL DATA	IEC	UL	CSA
	EN 60 947-7-2		
Cross-section fine-stranded	0.14 – 1.5 mm ²		
Cross-section solid/stranded	0.14 – 2.5 mm ²		
Cross-section, AWG		26–14	26–14
Rated voltage	500 V	300 V	300 V
Rated impulse voltage	6 kV		
Pollution degree	3		
ACCESSORIES	Type	Part No.	Std. Pack
End plate	AP WTP 1,5 D2/2	07.313.4655.0	10
Partition	TW WTP 1,5 D/E	07.313.5555.0	10

ACCESSORIES FOR FASIS WTP 1.5... PE



ACCESSORIES	Type	Part No.	Std. Pack
Warning cover	AD WTP 1,5	04.344.2655.0	10
Screwdriver	DIN 5264 B 0,4 X 2,5	06.502.4300.0	5
Marking accessories, see P. 140			

FASIS WTP · MULTI-TIER TERMINALS WITH PUSH-IN CONNECTION

WTP 1,5 E

- Multi-tier terminal with push-in connection for mounting on MR 35
- Nominal cross-section 1.5 mm²
- Assembly width of 3.5 mm



Description	Type	Part No.	Std. Pack
Multi-tier terminal	gray WTP 1,5 E	56.202.7055.0	100
GENERAL DATA			
Width / length / height, incl. MR 7.5	3.5 mm / 67 mm / 42 mm		
Wire strip length	8 mm		
Certificates / Approvals			
TECHNICAL DATA		IEC	UL
		CSA	
EN 60 947-7-1			
Cross-section fine-stranded	0.14 – 1.5 mm ²		
Cross-section solid/stranded	0.14 – 2.5 mm ²		
Cross-section, AWG	26–14	26–14	
Rated current	15 A	15 A	15 A
Rated voltage	500 V	300 V	300 V
Rated impulse voltage	6 kV		
Pollution degree	3		
ACCESSORIES		Type	Part No.
			Std. Pack
End plate	AP WTP 1,5 E	07.313.4755.0	10
Partition	TW WTP 1,5 D/E	07.313.5555.0	10
Jumper bar	2-pole IVB WTP 1,5-2	Z7.284.7027.0	10
	3-pole IVB WTP 1,5-3	Z7.284.7127.0	10
	4-pole IVB WTP 1,5-4	Z7.284.7227.0	10
	5-pole IVB WTP 1,5-5	Z7.284.7327.0	10
	10-pole IVB WTP 1,5-10	Z7.284.7427.0	10
Warning cover	AD WTP 1,5	04.344.2655.0	10

WTP 1,5 E VB

- Multi-tier terminal, connected vertically, with push-in connection for mounting on MR 35
- Nominal cross-section 1.5 mm²
- Assembly width of 3.5 mm



Description	Type	Part No.	Std. Pack
Multi-tier terminal	black WTP 1,5 EVB	56.202.6955.1	100
GENERAL DATA			
Width / length / height, incl. MR 7.5	3.5 mm / 67 mm / 42 mm		
Wire strip length	8 mm		
Certificates / Approvals			
TECHNICAL DATA		IEC	UL
		CSA	
EN 60 947-7-1			
Cross-section fine-stranded	0.14 – 1.5 mm ²		
Cross-section solid/stranded	0.14 – 2.5 mm ²		
Cross-section, AWG	26–14	26–14	
Rated current	15 A	15 A	15 A
Rated voltage	500 V	300 V	300 V
Rated impulse voltage	6 kV		
Pollution degree	3		
ACCESSORIES		Type	Part No.
			Std. Pack
End plate	AP WTP 1,5 E	07.313.4755.0	10
Partition	TW WTP 1,5 D/E	07.313.5555.0	10
Jumper bar	2-pole IVB WTP 1,5-2	Z7.284.7027.0	10
	3-pole IVB WTP 1,5-3	Z7.284.7127.0	10
	4-pole IVB WTP 1,5-4	Z7.284.7227.0	10
	5-pole IVB WTP 1,5-5	Z7.284.7327.0	10
	10-pole IVB WTP 1,5-10	Z7.284.7427.0	10
Warning cover	AD WTP 1,5	04.344.2655.0	10

WTP 1,5 E PE

- Multi-tier ground terminal with push-in connection for mounting on MR 35
- Nominal cross-section 1.5 mm²
- Assembly width of 3.5 mm

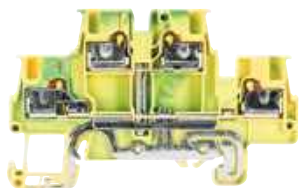

Description	Type	Part No.	Std. Pack
Multi-tier ground terminal	green/yellow WTP 1,5 EPE	56.202.9255.0	100
GENERAL DATA			
Width / length / height, incl. MR 7.5	3.5 mm / 67 mm / 42 mm		
Wire strip length	8 mm		
Certificates / Approvals			
TECHNICAL DATA		IEC	UL
		CSA	
EN 60 947-7-2			
Cross-section fine-stranded	0.14 – 1.5 mm ²		
Cross-section solid/stranded	0.14 – 2.5 mm ²		
Cross-section, AWG	26–14	26–14	
Rated voltage	500 V	300 V	300 V
Rated impulse voltage	6 kV		
Pollution degree	3		
ACCESSORIES		Type	Part No.
			Std. Pack
End plate	AP WTP 1,5 E	07.313.4755.0	10
Partition	TW WTP 1,5 D/E	07.313.5555.0	10
Warning cover	AD WTP 1,5	04.344.2655.0	10

FASIS WTP · INITIATOR TERMINALS WITH PUSH-IN CONNECTION

WTP 1,5 I/O -3

- Three-wire initiator/actuator terminal with push-in connection for mounting on MR 35
- Nominal cross-section 1.5 mm²
- Assembly width of 3.5 mm



Description	Type	Part No.	Std. Pack
Initiator/actuator terminal	gray WTP 1,5 I/O-3	56.202.8055.0	50
Initiator/actuator terminal with indicator		Upon request	
GENERAL DATA			
Width / length / height, incl. MR 7.5	3.5 mm / 94 mm / 42 mm		
Wire strip length	8 mm		
Certificates / Approvals			
TECHNICAL DATA			
	IEC	UL	CSA
	EN 60 947-7-1		
Cross-section fine-stranded	0.14 - 1.5 mm ²		
Cross-section solid/stranded	0.14 - 2.5 mm ²		
Cross-section, AWG	26-14		26-14
Rated current	13.5 A		
Rated voltage	250 V		
Rated impulse voltage	4 kV		
Pollution degree	3		
ACCESSORIES			
End plate	AP WTP 1,5 I/O	07.313.4855.0	10

WTP 1,5 I/O -4...

- Four-wire initiator/actuator terminal with push-in connection for mounting on MR 35
- Nominal cross-section 1.5 mm²
- Assembly width of 3.5 mm



Description	Type	Part No.	Std. Pack
Initiator/actuator terminal	gray WTP 1,5 I/O-4	56.202.8155.0	100
Initiator/actuator terminal	gray WTP 1,5 I/O-4 PE	56.202.9555.0	100
Initiator/actuator terminal with indicator		Upon request	
GENERAL DATA			
Width / length / height, incl. MR 7.5	3.5 mm / 94 mm / 42 mm		
Wire strip length	8 mm		
Certificates / Approvals			
TECHNICAL DATA			
	IEC	UL	CSA
	EN 60 947-7-1		
Cross-section fine-stranded	0.14 - 1.5 mm ²		
Cross-section solid/stranded	0.14 - 2.5 mm ²		
Cross-section, AWG	26-14		26-14
Rated current	13.5 A		
Rated voltage	250 V		
Rated impulse voltage	4 kV		
Pollution degree	3		
ACCESSORIES			
End plate	AP WTP 1,5 I/O	07.313.4855.0	10

WTP 1,5 I/O -IN...

- Feeder terminal for initiator/actuator terminal with push-in connection for mounting on MR 35
- Nominal cross-section 2.5 mm²
- Assembly width of 7 mm



Description	Type	Part No.	Std. Pack
Feeder terminal	black WTP 1,5 I/O-IN	56.202.8255.0	20
Feeder terminal	black WTP 1,5 I/O-IN PE	56.202.9655.0	20
GENERAL DATA			
Width / length / height, incl. MR 7.5	7 mm / 94 mm / 42 mm		
Wire strip length	8 mm		
Certificates / Approvals			
TECHNICAL DATA			
	IEC	UL	CSA
	EN 60 947-7-1/-2		
Cross-section fine-stranded	0.2 - 4 mm ²		
Cross-section solid/stranded	0.2 - 4 mm ²		
Cross-section, AWG	24-12		24-12
Rated current	17.5 A		
Rated voltage	250 V		
Rated impulse voltage	4 kV		
Pollution degree	3		
ACCESSORIES			
End plate	AP WTP 1,5 I/O	07.313.4855.0	10

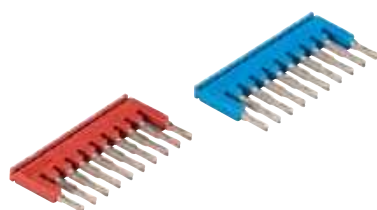

ACCESSORIES FOR WTP 1.5 I/O...	Type	Part No.	Std. Pack	
Jumper bar, red	2-pole	IVB WTP 1,5-2 rot	Z7.284.7027.5	10
	3-pole	IVB WTP 1,5-3 rot	Z7.284.7127.5	10
	4-pole	IVB WTP 1,5-4 rot	Z7.284.7227.5	10
	5-pole	IVB WTP 1,5-5 rot	Z7.284.7327.5	10
	10-pole	IVB WTP 1,5-10 rot	Z7.284.7427.5	10
Jumper bar, blue	2-pole	IVB WTP 1,5-2 blau	Z7.284.7027.6	10
	3-pole	IVB WTP 1,5-3 blau	Z7.284.7127.6	10
	4-pole	IVB WTP 1,5-4 blau	Z7.284.7227.6	10
	5-pole	IVB WTP 1,5-5 blau	Z7.284.7327.6	10
	10-pole	IVB WTP 1,5-10 blau	Z7.284.7427.6	10
Screwdriver		DIN 5264 B 0,4 X 2,5	06.502.4300.0	5
Marking accessories, see P. 140				

Technical information see FACTS & DATA page 158 ff.

Subject to technical modifications

FASIS WTP · FEED-THROUGH BLOCKS WITH PUSH-IN CONNECTION

WTP 2,5/4

- Feed-through block with push-in connection for mounting on TS 35
- Nominal cross section 4 mm²



Description	Type	Part No.	Std. Pack
Feed-through block	gray WTP 2,5/4	56.203.0055.0	100
Feed-through block	blue WTP 2,5/4 BLAU	56.203.0055.6	100
GENERAL DATA			
Width / length / height, incl. TS 7.5	5 mm / 47 mm / 38 mm		
Wire strip length	11 mm		
Approvals			
TECHNICAL DATA			
	IEC	UL	CSA
	EN 60 947-7-1		
Cross section fine-stranded	0.2 – 4 mm ²		
Cross section solid/stranded	0.2 – 4 mm ²		
Cross section, AWG		24 – 12	22 – 12
Rated current (UL field/factory wiring)	30 A	20 A/30 A	20 A
Rated voltage	800 V*	600 V	600 V
Rated impulse voltage	8 kV		
Pollution degree	3		
ACCESSORIES			
	Type	Part No.	Std. Pack
End plate	gray APFN 2,5	07.312.6755.0	10
Partition	gray TWFN 2,5	07.312.6855.0	10

* When cross connector IVB WKF 2,5-... is used, the rated voltage must be reduced to 630 V.

WTP 2,5/4 D1/2

- Duo feed-through block with push-in connection for mounting on TS 35
- Nominal cross section 4 mm²



Description	Type	Part No.	Std. Pack
Feed-through block	gray WTP 2,5/4 D1/2	56.203.5055.0	100
Feed-through block	blue WTP 2,5/4 D1/2 BLAU	56.203.5055.6	100
GENERAL DATA			
Width / length / height, incl. TS 7.5	5 mm / 60 mm / 38 mm		
Wire strip length	11 mm		
Approvals			
TECHNICAL DATA			
	IEC	UL	CSA
	EN 60 947-7-1		
Cross section fine-stranded	0.2 – 4 mm ²		
Cross section solid/stranded	0.2 – 4 mm ²		
Cross section, AWG		24 – 12	22 – 12
Rated current (UL field/factory wiring)	30 A	20 A/30 A	20 A
Rated voltage	800 V*	600 V	600 V
Rated impulse voltage	8 kV		
Pollution degree	3		
ACCESSORIES			
	Type	Part No.	Std. Pack
End plate	gray APFN 2,5 D1/2	07.312.6955.0	10
Partition	gray TWFN 2,5 D1/2	07.312.7055.0	10

* When cross connector IVB WKF 2,5-... is used, the rated voltage must be reduced to 630 V.

WTP 2,5/4 D2/2

- Duo feed-through block with push-in connection for mounting on TS 35
- Nominal cross section 4 mm²



Description	Type	Part No.	Std. Pack
Feed-through block	gray WTP 2,5/4 D2/2	56.203.5155.0	100
Feed-through block	blue WTP 2,5/4 D2/2 BLAU	56.203.5155.6	100
GENERAL DATA			
Width / length / height, incl. TS 7.5	5 mm / 72 mm / 38 mm		
Wire strip length	11 mm		
Approvals			
TECHNICAL DATA			
	IEC	UL	CSA
	EN 60 947-7-1		
Cross section fine-stranded	0.2 – 4 mm ²		
Cross section solid/stranded	0.2 – 4 mm ²		
Cross section, AWG		24 – 12	22 – 12
Rated current (UL field/factory wiring)	30 A	20 A/30 A	20 A
Rated voltage	800 V*	600 V	600 V
Rated impulse voltage	8 kV		
Pollution degree	3		
ACCESSORIES			
	Type	Part No.	Std. Pack
End plate	gray APFN 2,5 D2/2	07.312.7155.0	10
Partition	gray TWFN 2,5 D2/2	07.312.7255.0	10

* When cross connector IVB WKF 2,5-... is used, the rated voltage must be reduced to 630 V.

FASIS WTP · GROUND BLOCKS WITH PUSH-IN CONNECTION

WTP 2,5/4 PE

- Ground block with push-in connection for mounting on TS 35
- Nominal cross section 4 mm²



* When cross connector IVB WKF 2,5-... is used, the rated voltage must be reduced to 630 V.

Description	Type	Part No.	Std. Pack
Ground block	green/yellow WTP 2,5/4 PE	56.203.9055.0	100
GENERAL DATA			
Width / length / height, incl. TS 7.5	5 mm / 47 mm / 38 mm		
Wire strip length	11 mm		
Approvals			
TECHNICAL DATA			
	IEC	UL	CSA
	EN 60 947-7-2		
Cross section fine-stranded	0.2 – 4 mm ²		
Cross section solid/stranded	0.2 – 4 mm ²		
Cross section, AWG	24 – 12		22 – 12
Rated current			
Rated voltage	800 V *	600 V	600 V
Rated impulse voltage	8 kV		
Pollution degree	3		
ACCESSORIES			
	Type	Part No.	Std. Pack
End plate	gray APFN 2,5	07.312.6755.0	10
Partition	gray TWFN 2,5	07.312.6855.0	10

WTP 2,5/4 D1/2/PE

- Duo ground block with push-in connection for mounting on TS 35
- Nominal cross section 4 mm²



* When cross connector IVB WKF 2,5-... is used, the rated voltage must be reduced to 630 V.

Description	Type	Part No.	Std. Pack
Ground block	green/yellow WTP 2,5/4 D1/2/PE	56.203.9355.0	100
GENERAL DATA			
Width / length / height, incl. TS 7.5	5 mm / 60 mm / 38 mm		
Wire strip length	11 mm		
Approvals			
TECHNICAL DATA			
	IEC	UL	CSA
	EN 60 947-7-2		
Cross section fine-stranded	0.2 – 4 mm ²		
Cross section solid/stranded	0.2 – 4 mm ²		
Cross section, AWG	24 – 12		22 – 12
Rated current			
Rated voltage	800 V *	600 V	600 V
Rated impulse voltage	8 kV		
Pollution degree	3		
ACCESSORIES			
	Type	Part No.	Std. Pack
End plate	gray APFN 2,5 D1/2	07.312.6955.0	10
Partition	gray TWFN 2,5 D1/2	07.312.7055.0	10

WTP 2,5/4 D2/2/PE

- Duo ground block with push-in connection for mounting on TS 35
- Nominal cross section 4 mm²



* When cross connector IVB WKF 2,5-... is used, the rated voltage must be reduced to 630 V.

Description	Type	Part No.	Std. Pack
Ground block	green/yellow WTP 2,5/4 D2/2/PE	56.203.9155.0	100
GENERAL DATA			
Width / length / height, incl. TS 7.5	5 mm / 72 mm / 38 mm		
Wire strip length	11 mm		
Approvals			
TECHNICAL DATA			
	IEC	UL	CSA
	EN 60 947-7-2		
Cross section fine-stranded	0.2 – 4 mm ²		
Cross section solid/stranded	0.2 – 4 mm ²		
Cross section, AWG	24 – 12		22 – 12
Rated current			
Rated voltage	800 V *	600 V	600 V
Rated impulse voltage	8 kV		
Pollution degree	3		
ACCESSORIES			
	Type	Part No.	Std. Pack
End plate	gray APFN 2,5 D2/2	07.312.7155.0	10
Partition	gray TWFN 2,5 D2/2	07.312.7255.0	10

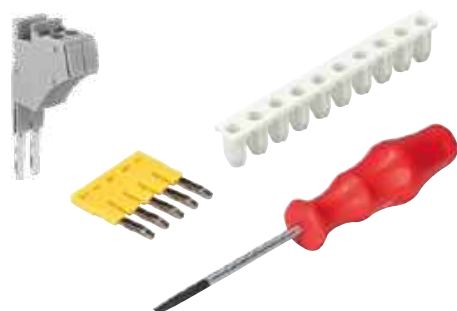

ACCESSORIES FOR WTP 2,5/4...	Type	Part No.	Std. Pack
Cross connector, insulated	2-pole IVB WKF 2,5 – 2	Z7.280.6227.0	10
	3-pole IVB WKF 2,5 – 3	Z7.280.6327.0	10
	4-pole IVB WKF 2,5 – 4	Z7.280.6427.0	10
	5-pole IVB WKF 2,5 – 5	Z7.280.6527.0	10
	10-pole IVB WKF 2,5 – 10	Z7.280.7027.0	20
Wire entry guide	20-pole IVB WKF 2,5 – 20	Z7.280.8027.0	20
	0.13 – 0.2 mm ² LELN 2,5/1 WEISS	05.564.3755.0	100
	0.25 – 0.5 mm ² LELN 2,5/2 GRAU	05.564.3855.0	100
	0.75 – 1.0 mm ² LELN 2,5/3 SCHWARZ	05.564.3955.0	100
Test adapter, modular	PS WKC/F	Z1.299.9753.0	10
Test plug	ST 2/2,3	Z5.553.2921.0	10
Screwdriver, uninsulated	DIN 5264 B 0,6x3,5	06.502.4000.0	5
Screwdriver, uninsulated, MINI	DIN 5264 B 0,6x3,5 M	06.502.5000.0	10
Marking material see page 140			

Technical information see FACTS & DATA page 158 ff.

Subject to technical modifications

FASIS WTP · MULTI-TIER BLOCKS WITH PUSH-IN CONNECTION

WTP 2,5/4 E

- Multi-tier block with push-in connection for mounting on TS 35
- Nominal cross section 4 mm²



Description	Type	Part No.	Std. Pack
Multi-tier block	gray WTP 2,5/4 E	56.203.7055.0	100
GENERAL DATA			
Width / length / height, incl. TS 7.5	5 mm / 82 mm / 48 mm		
Wire strip length	11 mm		
Approvals			
TECHNICAL DATA			
	IEC	UL	CSA
	EN 60 947-7-1		
Cross section fine-stranded	0.2 – 4 mm ²		
Cross section solid/stranded	0.2 – 4 mm ²		
Cross section, AWG	24 – 12	22 – 12	
Rated current	24 A	20 A	20 A
Rated voltage	500 V	300 V	300 V
Rated impulse voltage	6 kV		
Pollution degree	3		
ACCESSORIES			
End plate	gray APFN 2,5 E	07.312.7355.0	10
Partition	gray TWFN 2,5 E	07.312.7455.0	10
Marking tag carrier, 2-fold	BT 5/2	04.243.0855.0	100

WTP 2,5/4 E VB

- Multi-tier block, vertically connected, with push-in connection for mounting on TS 35
- Nominal cross section 4 mm²

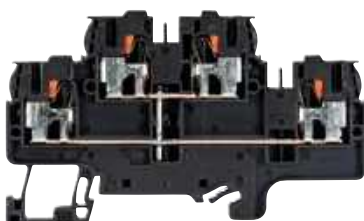

Description	Type	Part No.	Std. Pack
Multi-tier block	black WTP 2,5/4 E VB	56.203.6955.1	100
GENERAL DATA			
Width / length / height, incl. TS 7.5	5 mm / 82 mm / 48 mm		
Wire strip length	11 mm		
Approvals			
TECHNICAL DATA			
	IEC	UL	CSA
	EN 60 947-7-2		
Cross section fine-stranded	0.2 – 4 mm ²		
Cross section solid/stranded	0.2 – 4 mm ²		
Cross section, AWG	24 – 12	22 – 12	
Rated current	24 A	20 A	20 A
Rated voltage	500 V	300 V	300 V
Rated impulse voltage	6 kV		
Pollution degree	3		
ACCESSORIES			
End plate	gray APFN 2,5 E	07.312.7355.0	10
Partition	gray TWFN 2,5 E	07.312.7455.0	10
Marking tag carrier, 2-fold	BT 5/2	04.243.0855.0	100

WTP 2,5/4 E PE

- Multi-tier ground block with push-in connection for mounting on TS 35
- Nominal cross section 4 mm²

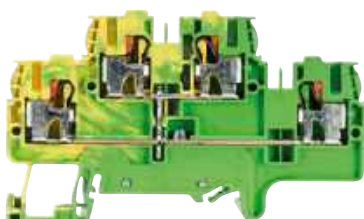

Description	Type	Part No.	Std. Pack
Multi-tier ground block	green/yellow WTP 2,5/4 E PE	56.203.8955.0	100
GENERAL DATA			
Width / length / height, incl. TS 7.5	5 mm / 82 mm / 48 mm		
Wire strip length	11 mm		
Approvals			
TECHNICAL DATA			
	IEC	UL	CSA
	EN 60 947-7-2		
Cross section fine-stranded	0.2 – 4 mm ²		
Cross section solid/stranded	0.2 – 4 mm ²		
Cross section, AWG	24 – 12	22 – 12	
Rated current			
Rated voltage	500 V	300 V	300 V
Rated impulse voltage	6 kV		
Pollution degree	3		
ACCESSORIES			
End plate	gray APFN 2,5 E	07.312.7355.0	10

ACCESSORIES FOR FASIS WTP 2,5/4

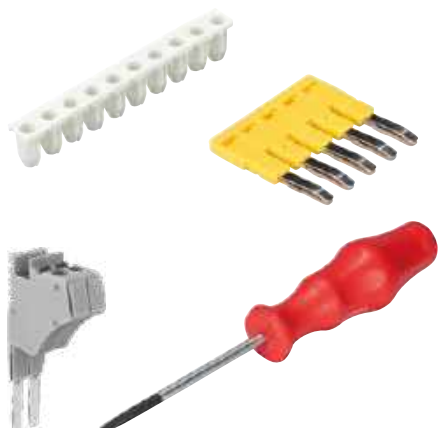

ACCESSORIES	Type	Part No.	Std. Pack	
Cross connector, insulated	2-pole	IVB WKF 2,5 – 2	Z7.280.6227.0	10
	3-pole	IVB WKF 2,5 – 3	Z7.280.6327.0	10
	4-pole	IVB WKF 2,5 – 4	Z7.280.6427.0	10
	5-pole	IVB WKF 2,5 – 5	Z7.280.6527.0	10
	6-pole	IVB WKF 2,5 – 6	Z7.280.6627.0	10
	7-pole	IVB WKF 2,5 – 7	Z7.280.6727.0	20
	8-pole	IVB WKF 2,5 – 8	Z7.280.6827.0	20
	9-pole	IVB WKF 2,5 – 9	Z7.280.6927.0	20
	10-pole	IVB WKF 2,5 – 10	Z7.280.7027.0	20
	20-pole	IVB WKF 2,5 – 20	Z7.280.8027.0	20
Wire entry guide	0.13 – 0.2 mm ²	LELN 2,5/1 WEISS	05.564.3755.0	100
	0.25 – 0.5 mm ²	LELN 2,5/2 GRAU	05.564.3855.0	100
	0.75 – 1.0 mm ²	LELN 2,5/3 SCHWARZ	05.564.3955.0	100
Test adapter, modular		PS WKC/F	Z1.299.9753.0	10
Test plug		ST 2/2,3	Z5.553.2921.0	10
Screwdriver, uninsulated		DIN 5264 B 0,6x3,5	06.502.4000.0	5
Screwdriver, uninsulated, MINI		DIN 5264 B 0,6x3,5 M	06.502.5000.0	10
Marking material see page 140				

Technical information see FACTS & DATA page 158 ff.

Subject to technical modifications

FASIS WTP · FEED-THROUGH BLOCKS WITH PUSH-IN CONNECTION

WTP 6/10

- Feed-through block with push-in connection for mounting on TS 35
- Nominal cross section 10 mm²



Description	Type	Part No.	Std. Pack
Feed-through block	gray WTP 6/10	56.206.0055.0	100
Feed-through block	blue WTP 6/10 BLAU	56.206.0055.6	100

GENERAL DATA			
Width / length / height, incl. TS 7.5	8 mm / 58 mm / 44 mm		
Wire strip length	15 mm		
Approvals			
TECHNICAL DATA			
	IEC	UL	CSA
	EN 60 947-7-1		
Cross section fine-stranded	0,2 – 10 mm ²		
Cross section solid/stranded	0.2 – 10 mm ²		
Cross section, AWG		10 – 8	12 – 8
Rated current	57 A	41 A	41 A
Rated voltage	1000 V*	600 V	600 V
Rated impulse voltage	8 kV		
Pollution degree	3		

ACCESSORIES	Type	Part No.	Std. Pack
End plate	gray AP WTP 6/10	07.313.4155.0	10
Partition	gray TW WTP 6/10	07.313.4255.0	10

* When cross connector IVB WKFN 6-... is used, the rated voltage must be reduced to 800 V.

WTP 6/10 D1/2

- Feed-through block with push-in connection for mounting on TS 35
- Nominal cross section 10 mm²



Description	Type	Part No.	Std. Pack
Feed-through block	gray WTP 6/10 D1/2	56.206.5055.0	50
Feed-through block	blue WTP 6/10 D1/2 BLAU	56.206.5055.6	50

GENERAL DATA			
Width / length / height, incl. TS 7.5	8 mm / 77 mm / 44 mm		
Wire strip length	15 mm		
Approvals			
TECHNICAL DATA			
	IEC		
	EN 60 947-7-1		
Cross section fine-stranded	0,2 – 10 mm ²		
Cross section solid/stranded	0.2 – 10 mm ²		
Cross section, AWG			
Rated current	57 A		
Rated voltage	1000 V*		
Rated impulse voltage	8 kV		
Pollution degree	3		

ACCESSORIES	Type	Part No.	Std. Pack
End plate	gray AP WTP 6/10 D1/2	07.313.5355.0	10
Partition	gray TW WTP 6/10 Dx/2	07.313.5255.0	10

* When cross connector IVB WKFN 6-... is used, the rated voltage must be reduced to 800 V.

WTP 6/10 D2/2

- Feed-through block with push-in connection for mounting on TS 35
- Nominal cross section 10 mm²



Description	Type	Part No.	Std. Pack
Feed-through block	gray WTP 6/10 D2/2	56.206.5155.0	50
Feed-through block	blue WTP 6/10 D2/2 BLAU	56.206.5155.6	50

GENERAL DATA			
Width / length / height, incl. TS 7.5	8 mm / 94 mm / 44 mm		
Wire strip length	15 mm		
Approvals			
TECHNICAL DATA			
	IEC		
	EN 60 947-7-1		
Cross section fine-stranded	0,2 – 10 mm ²		
Cross section solid/stranded	0.2 – 10 mm ²		
Cross section, AWG			
Rated current	57 A		
Rated voltage	1000 V*		
Rated impulse voltage	8 kV		
Pollution degree	3		

ACCESSORIES	Type	Part No.	Std. Pack
End plate	gray AP WTP 6/10 D2/2	07.313.5455.0	10
Partition	gray TW WTP 6/10 Dx/2	07.313.5255.0	10

* When cross connector IVB WKFN 6-... is used, the rated voltage must be reduced to 800 V.

FASIS WTP · GROUND BLOCKS WITH PUSH-IN CONNECTION

WTP 6/10 PE

- Ground block with push-in connection for mounting on TS 35
- Nominal cross section 10 mm²



* When cross connector IVB WKFN 6-... is used, the rated voltage must be reduced to 800 V.

Description	Type	Part No.	Std. Pack
Ground block	green/yellow	WTP 6/10 PE	56.206.9055.0

GENERAL DATA

Width / length / height, incl. TS 7.5	8 mm / 58 mm / 44 mm
Wire strip length	15 mm
Approvals	

TECHNICAL DATA

	IEC	UL	CSA
	EN 60 947-7-2		
Cross section fine-stranded	0.2 – 10 mm ²		
Cross section solid/stranded	0.2 – 10 mm ²		
Cross section, AWG		10 – 8	12 – 8
Rated current			
Rated voltage	1000 V*	600 V	600 V
Rated impulse voltage	8 kV		
Pollution degree	3		

ACCESSORIES

Description	Type	Part No.	Std. Pack
End plate	gray	AP WTP 6/10	07.313.4155.0
Partition	gray	TW WTP 6/10	07.313.4255.0

WTP 6/10 D1/2 PE

- Ground block with push-in connection for mounting on TS 35
- Nominal cross section 10 mm²

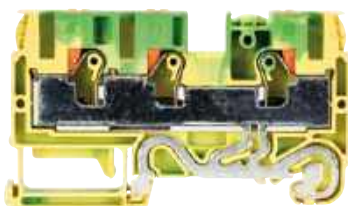

* When cross connector IVB WKFN 6-... is used, the rated voltage must be reduced to 800 V.

Description	Type	Part No.	Std. Pack
Ground block	green/yellow	WTP 6/10 D1/2 PE	56.206.9355.0

GENERAL DATA

Width / length / height, incl. TS 7.5	8 mm / 77 mm / 44 mm
Wire strip length	15 mm
Approvals	

TECHNICAL DATA

	IEC
	EN 60 947-7-2
Cross section fine-stranded	0.2 – 10 mm ²
Cross section solid/stranded	0.2 – 10 mm ²
Cross section, AWG	
Rated current	
Rated voltage	1000 V*
Rated impulse voltage	8 kV
Pollution degree	3

ACCESSORIES

Description	Type	Part No.	Std. Pack
End plate	gray	AP WTP 6/10 D1/2	07.313.5355.0
Partition	gray	TW WTP 6/10 Dx/2	07.313.5255.0

WTP 6/10 D2/2 PE

- Ground block with push-in connection for mounting on TS 35
- Nominal cross section 10 mm²

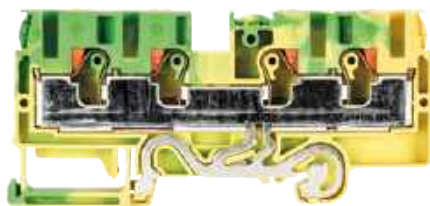

* When cross connector IVB WKFN 6-... is used, the rated voltage must be reduced to 800 V.

Description	Type	Part No.	Std. Pack
Ground block	green/yellow	WTP 6/10 D2/2 PE	56.206.9155.0

GENERAL DATA

Width / length / height, incl. TS 7.5	8 mm / 94 mm / 44 mm
Wire strip length	15 mm
Approvals	

TECHNICAL DATA

	IEC
	EN 60 947-7-2
Cross section fine-stranded	0.2 – 10 mm ²
Cross section solid/stranded	0.2 – 10 mm ²
Cross section, AWG	
Rated current	
Rated voltage	1000 V*
Rated impulse voltage	8 kV
Pollution degree	3

ACCESSORIES

Description	Type	Part No.	Std. Pack
End plate	gray	AP WTP 6/10 D2/2	07.313.5455.0
Partition	gray	TW WTP 6/10 Dx/2	07.313.5255.0

ACCESSORIES FOR FASIS WTP 6/10



ACCESSORIES

Description	Type	Part No.	Std. Pack
Cross connector, insulated, I _n : 41 A	2-pole	IVB WKFN 6 – 2	Z7.282.5227.0
(57 A when using	3-pole	IVB WKFN 6 – 3	Z7.282.5327.0
two cross connectors)	4-pole	IVB WKFN 6 – 4	Z7.282.5427.0
	5-pole	IVB WKFN 6 – 5	Z7.282.5527.0
Test plug		ST 2/2,3	Z5.553.2921.0
Screwdriver, uninsulated		DIN 5264 B 0,8x4	06.502.4100.0
Marking material see page 140			

FASIS BIT · MULTI-TIER TERMINALS FOR INSTALLATION DISTRIBUTION BOARDS WITH PUSH-IN CONNECTION

WKIS 2.5 D

- Installation multi-tier terminal with push-in connection for mounting on TS 35
- Nominal cross section 2.5 mm²



Description	Type	Part No.	Std. Pack
Installation rail terminal blocks	WKIS 2,5 D	56.203.9653.0	50

GENERAL DATA

Width / length / height, incl. TS 7.5	5 mm / 100 mm / 51.1 mm
Wire strip length	11 mm
Approvals	

TECHNICAL DATA

	IEC
	EN 60 947-7-1
Cross section fine-stranded	0.14-4 mm ²
Cross section solid/stranded	0.14-4 mm ²
Cross-section, AWG	
Rated current	24 A
Rated voltage	400 V
Rated impulse voltage	6 kV
Pollution degree	3

ACCESSORIES

	Type	Part No.	Std. Pack
End plate	APIS 2,5..	07.313.0253.0	10
Jumper bar	2-pole	IVBWK 2,5 - 2	10
	3-pole	IVBWK 2,5 - 3	10
	10-pole	IVBWK 2,5 - 10	20
	20-pole	IVBWK 2,5 - 20	20
Busbar	9813 M SN 10X3 1000MM	98.290.1000.0	1

WKIS 2.5 D-D

WKIS 2.5 N-D

- Installation multi-tier terminal with push-in connection for mounting on TS 35
- Nominal cross section 2.5 mm²



Description	Type	Part No.	Std. Pack
Installation rail terminal blocks	WKIS 2,5 D-D	56.203.9753.0	50
	WKIS 2,5 N-D	56.203.8953.0	50

GENERAL DATA

Width / length / height, incl. TS 7.5	5 mm / 100 mm / 51.1 mm
Wire strip length	11 mm
Approvals	

TECHNICAL DATA

	IEC
	EN 60 947-7-1
Cross section fine-stranded	0.14-4 mm ²
Cross section solid/stranded	0.14-4 mm ²
Cross-section, AWG	
Rated current	24 A
Rated voltage	400 V
Rated impulse voltage	6 kV
Pollution degree	3

ACCESSORIES

	Type	Part No.	Std. Pack
End plate	APIS 2,5..	07.313.0253.0	10
Jumper bar	2-pole	IVBWK 2,5 - 2	10
	2-pole	IVBWK 2,5 - 3	10
	10-pole	IVBWK 2,5 - 10	20
	20-pole	IVBWK 2,5 - 20	20
Busbar	9813 M SN 10X3 1000MM	98.290.1000.0	1

WKIS 2.5 D-D-SL

WKIS 2.5 N-D-SL

- Installation multi-tier terminal with push-in connection for mounting on TS 35
- Nominal cross section 2.5 mm²



Description	Type	Part No.	Std. Pack
Installation rail terminal blocks	WKIS 2,5 D-D-SL	56.203.9853.0	50
	WKIS 2,5 N-D-SL	56.203.9453.0	50

GENERAL DATA

Width / length / height, incl. TS 7.5	5 mm / 100 mm / 51.1 mm
Wire strip length	11 mm
Approvals	

TECHNICAL DATA

	IEC
	EN 60 947-7-1
Cross section fine-stranded	0.14-4 mm ²
Cross section solid/stranded	0.14-4 mm ²
Cross-section, AWG	
Rated current	24 A
Rated voltage	400 V
Rated impulse voltage	6 kV
Pollution degree	3

ACCESSORIES

	Type	Part No.	Std. Pack
End plate	APIS 2,5..	07.313.0253.0	10
Jumper bar	2-pole	IVBWK 2,5 - 2	10
	3-pole	IVBWK 2,5 - 3	10
	10-pole	IVBWK 2,5 - 10	20
	20-pole	IVBWK 2,5 - 20	20
Busbar	9813 M SN 10X3 1000MM	98.290.1000.0	1

More accessories page 130 ff.

WKIS 2.5 NT-D-SL

- Installation multi-tier terminal with push-in connection for mounting on TS 35
- Nominal cross section 2.5 mm²



Description	Type	Part No.	Std. Pack
Installation rail terminal blocks	WKIS 2,5 NT-D-SL	56.203.9553.0	50

GENERAL DATA

Width / length / height, incl. TS 7.5	5 mm / 100 mm / 51.2 mm
Wire strip length	11 mm
Approvals	

TECHNICAL DATA

	IEC
	EN 60 947-7-1
Cross section fine-stranded	0.14-4 mm ²
Cross section solid/stranded	0.14-4 mm ²
Cross-section, AWG	
Rated current	22 A
Rated voltage	400 V
Rated impulse voltage	4 kV
Pollution degree	3

ACCESSORIES

	Type	Part No.	Std. Pack
End plate	APIS 2,5..	07.313.0253.0	10
Jumper bar	2-pole	IVBWK 2,5 - 2	10
	3-pole	IVBWK 2,5 - 3	10
	10-pole	IVBWK 2,5 - 10	20
	20-pole	IVBWK 2,5 - 20	20
Busbar	9813 M SN 10X3 1000MM	98.290.1000.0	1

WKIS 2.5 NTM-D-SL

- Installation multi-tier terminal with push-in connection for mounting on TS 35
- Nominal cross section 2.5 mm²



Description	Type	Art.No.	Std. Pack
Installation rail terminal blocks with cutting knife	WKIS 2,5 NTM-D-SL	56.203.8653.0	50
Installation rail terminal blocks, same construction without cutting knife	WKIS 2,5 NTMD-D-SL	56.203.8553.0	50

GENERAL DATA

Width / length / height, incl. TS 7.5	5 mm / 100 mm / 50.7 mm
Wire strip length	11 mm
Approvals	

TECHNICAL DATA

	IEC
	EN 60 947-7-1
Cross section fine-stranded	0.14-4 mm ²
Cross section solid/stranded	0.14-4 mm ²
Cross-section, AWG	
Rated current	20 A
Rated voltage	400 V
Rated impulse voltage	4 kV
Pollution degree	3

ACCESSORIES

	Type	Part No.	Std. Pack
End plate	APIS 2,5 NTM-D-SL	07.313.0353.0	10
Jumper bar	2-pole	IVBWK 2,5 - 2	10
	3-pole	IVBWK 2,5 - 3	10
	10-pole	IVBWK 2,5 - 10	20
	20-pole	IVBWK 2,5 - 20	20

ACCESSORIES

To complement our products, we offer a comprehensive portfolio of accessories and services for terminal blocks.

Wieland offers a variety of product-specific accessories for its terminal blocks, for example covers and isolating plates as well as assembly materials such as mounting rails or tools for working with our products. Marking solutions such as wieplot and wiemarc for DIN rail terminal blocks and other components in the control cabinet, the planning software wieplan for design of rail assemblies, and our value-add service for rail assemblies, all make working with Wieland DIN rail terminal blocks effortless, and achieve a true added value.



**SHIELDED CABLE
TERMINAL BLOCKS**

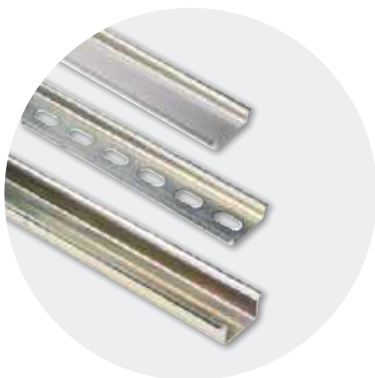

MOUNTING RAILS



END CLAMPS



**MARKING OF
DIN RAIL TERMINAL BLOCKS**





**CROSS CONNECTORS
AND JUMPER BARS**



**COVER STRIPS AND
TEST PLUGS**



TOOLS

WST – SHIELDED CABLE TERMINAL BLOCKS FOR TROUBLE-FREE OPERATION

High interference immunity is an important topic in industrial and process technology. It is one of the key factors affecting the availability of plants.

For our selos and fasis terminal block series, we offer WST, a system that enables the cable shield to be connected to the housing earth in a simple, practical manner.

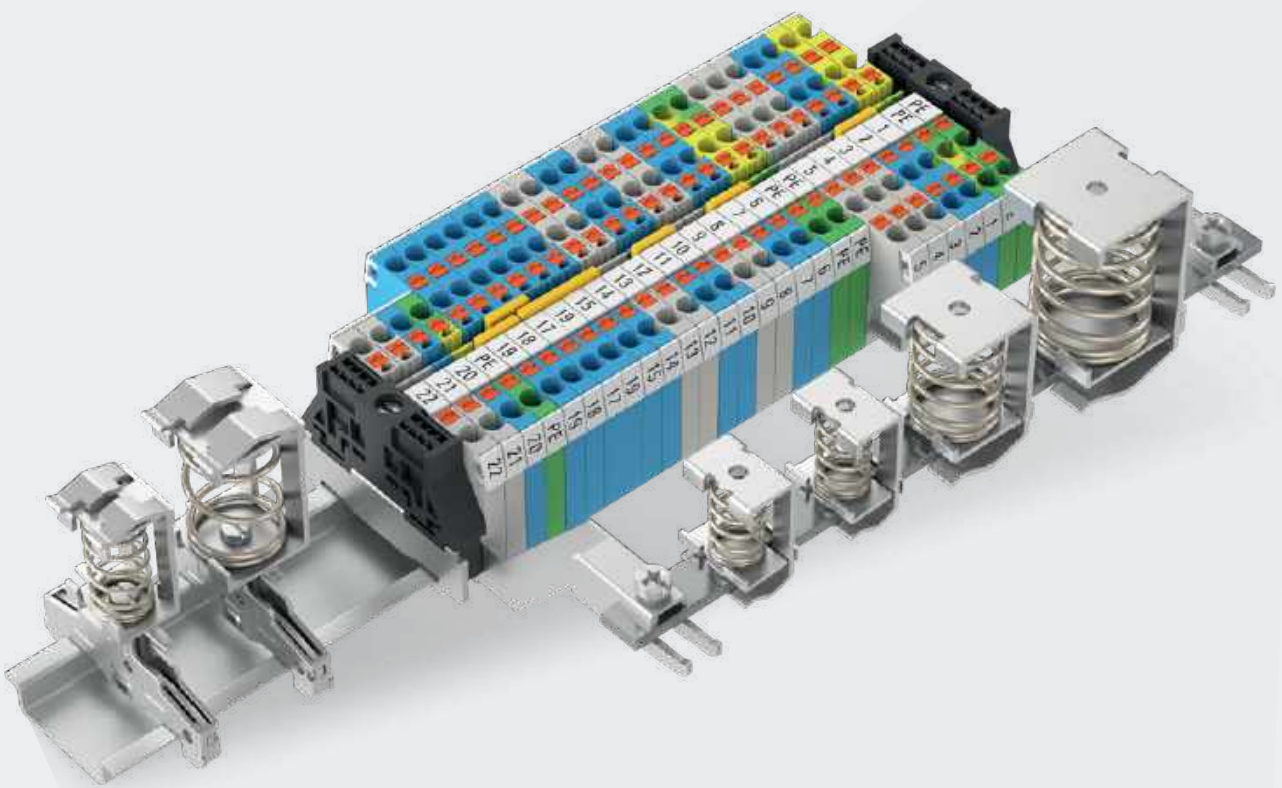

- + Simple mounting - also if upgraded, service and maintenance
- + Broad range – up to 32 mm cable diameter
- + Top-quality, maintenance-free technology
- + Vibration-proof spring-type technology
- + Large-area and low impedance connection
- + Highly corrosion resistance
- + Durable clamping body from hardened steel

WST – BUSBAR SUPPORT



Various applications

- On busbar
- On rail TS 35



- On C-profile
- With screw for mounting plates

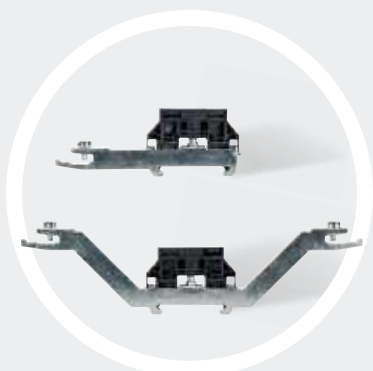

Various accessories

- Busbar support for TS 35
- Busbar support for insulated mounting



- Connection terminals



ACCESSORIES · SHIELDED CABLE TERMINALS

SHIELDED CABLE TERMINALS FASIS WST ...

- for mounting on busbar 10 x 3 mm



Description	Type	Part No.	Std. Pack	
Shielded cable terminals fasis				
8 mm	WST 8	Z2.803.3010.0	10	
13.5 mm	WST 13,5	Z2.803.3110.0	10	
20 mm	WST 20	Z2.803.3210.0	10	
32 mm	WST 32	Z2.803.3310.0	10	
Technical data				
Width / length / height [mm]	WST 8	WST 13.5	WST 20	WST 32
Connectible cable diameter	3 - 8 mm	4 - 13.5 mm	10 - 20 mm	15 - 32 mm

SHIELDED CABLE TERMINALS FASIS WST C

- for mounting on C-profile



Description	Type	Part No.	Std. Pack	
Shielded cable terminals fasis				
8 mm	WST 8 / C	Z2.803.4010.0	10	
13.5 mm	WST 13,5 / C	Z2.803.4110.0	10	
20 mm	WST 20 / C	Z2.803.4210.0	10	
32 mm	WST 32 / C	Z2.803.4310.0	10	
Technical data				
Width / length / height [mm]	WST 8 / C	WST 13.5 / C	WST 20 / C	WST 32 / C
Connectible cable diameter	3 - 8 mm	4 - 13.5 mm	10 - 20 mm	15 - 32 mm
Mounting screw	M 4	M 4	M 4	M 4
Accessories				
Mounting rail, galvanized steel	L = 2 m	98.400.0000.0	1	
Mounting feet	light gray	Z1.980.0040.0	10	

SHIELDED CABLE TERMINALS FASIS WST D

- for mounting on mounting plate



Description	Type	Part No.	Std. Pack	
Shielded cable terminals fasis				
8 mm	WST 8 / D	Z2.803.5010.0	10	
13.5 mm	WST 13,5 / D	Z2.803.5110.0	10	
20 mm	WST 20 / D	Z2.803.5210.0	10	
32 mm	WST 32 / D	Z2.803.5310.0	10	
Technical data				
Width / length / height [mm]	WST 8 / D	WST 13.5 / D	WST 20 / D	WST 32 / D
Connectible cable diameter	3 - 8 mm	4 - 13.5 mm	10 - 20 mm	15 - 32 mm
Mounting screw	M 4	M 4	M 4	M 4

SHIELDED CABLE TERMINALS FASIS WST .../T35

- for mounting on TS 35 mounting rail



Description	Type	Part No.	Std. Pack
Shielded cable terminals fasis			
8 mm	WST 8 / TS 35	Z2.803.6010.0	10
13.5 mm	WST 13,5 / TS 35	Z2.803.6110.0	10
20 mm	WST 20 / TS 35	Z2.803.6210.0	10
Technical data			
Width / length / height [mm]	WST 8	WST 13.5	WST 20
Connectible cable diameter	3 - 8 mm	4 - 13.5 mm	10 - 20 mm

ACCESSORIES · BUSBAR SUPPORT

BUSBAR SUPPORT



Description	Type	Part No.	Std. Pack
Busbar support			
Busbar support (one-side), tin-plated steel	WE SH 1/35	Z5.515.3310.0	20
Busbar support (two-sided), tin-plated steel	WE SH 2/35	Z5.515.3410.0	20
Busbar support (two-sided), tin-plated steel	WE SH 3/35	Z5.519.0310.0	25
Busbar support (one-side), tin-plated steel	WE SH 4/35	Z5.519.0410.0	25
Busbar support plastic, black	WST H 10x3	Z1.980.0253.0	20

ACCESSORIES



Description	Type	Part No.	Std. Pack
Accessories			
Ground Terminal, bright	WAK 35/2	30.494.4121.0	50
Ground Terminal, black	WAK 35/2 SW	30.494.4021.1	50
Busbar, Cu tin-plated copper	L = 1 m 9813M SN 10x3	98.290.1000.0	20



ACCESSORIES · MOUNTING RAILS

MOUNTING RAIL 35X7,5 ACCORDING TO DIN EN 60 715

- Length 2 m



Description	Type	Part No.	Std. Pack
Steel, galv. zinc-plated and dichromated	unslotted	35 x 27 x 7,5 EN 60715 2000mm	98.300.0000.0 1
Steel, galv. zinc-plated and dichromated	slotted	35 x 27 x 7,5 EN 60715 2000mm	98.300.1000.0 1
Steel, unplated	unslotted	35 x 27 x 7,5 EN 60715 2000mm	98.300.0010.0 1



MOUNTING RAIL 35X15 ACCORDING TO DIN EN 60 715

- Length 1 m/2 m



Description	Type	Part No.	Std. Pack
Steel, galv. zinc-plated and dichromated	unslotted	35 x 27 x 15 EN 60715 2000mm	98.370.0000.0 1
Steel, galv. zinc-plated and dichromated	slotted	35 x 27 x 15 EN 60715 2000mm	98.370.1000.0 1
Steel, galv. zinc-plated and dichromated	slotted	35 x 27 x 15 EN 60715 1000mm	98.375.1000.0 10
Steel, stainless steel	slotted	35 x 27 x 15 EN 60715 2000mm	98.370.1001.0 1

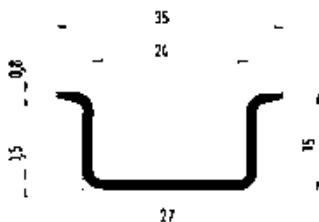

MOUNTING RAIL 35X15 ACCORDING TO DIN EN 60 715

- Length 2 m



Description	Type	Part No.	Std. Pack
Steel, galv. zinc-plated and dichromated	unslotted	35 x 24 x 15 EN 60715 2000mm	98.360.0000.0 1
Steel, hot-galvanized	unslotted	35 x 24 x 15 EN 60715 ZN 2000mm	98.360.0004.0 1
E-copper	unslotted	35 x 24 x 15 EN 60715 CU 2000mm	98.380.0000.0 10

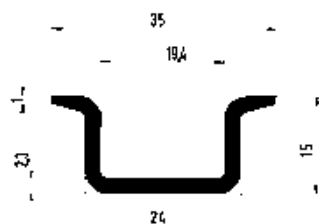

MOUNTING RAIL 15X5,5 ACCORDING TO DIN EN 60 715

- Length 1 m/2 m

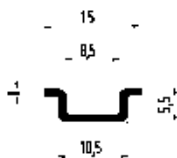

Description	Type	Part No.	Std. Pack	
Steel, galv. zinc-plated and dichromated	slotted	9021 / 15 x 5,5 EN 60715 2000mm	98.090.0015.0	10
Steel, galv. zinc-plated and dichromated	slotted	9021 / 15 x 5,5 EN 60715 1000mm	98.090.0000.0	1

MOUNTING RAIL 32 ACCORDING TO DIN EN 60 715

- Length 2 m



Description	Type	Part No.	Std. Pack	
Steel, galv. zinc-plated and dichromated	unslotted	9006 EN 60715 G-32 2000mm	98.190.0000.0	1
Steel, galv. zinc-plated and dichromated	slotted	9006 EN 60715 G-32 2000mm	98.190.1000.0	1
E-copper	unslotted	9006 E-CU 2000mm	98.220.0000.0	10
Aluminium	unslotted	9006 AL 2000mm	98.210.0000.0	1



ACCESSORIES

9018 D



9018 H



9018 N



ACCESSORIES	Type	Part No.	Std. Pack
Angled support bracket with mounting material	9018 D	Z5.516.2511.0	50
Angled support bracket with mounting material	9018 H	Z5.516.2711.0	50
Angled support bracket with mounting material	9018 N	Z5.516.2811.0	50



ACCESSORIES · END CLAMPS

END CLAMP FOR TS 35 SNAP-ON MOUNTING

Description	Type	Part No.	Std. Pack
End clamp TS 35	5 mm wide WEF 2 /35	Z5.523.9453.0	100



END CLAMP FOR TS 35 SNAP-ON MOUNTING

Description	Type	Part No.	Std. Pack
End clamp TS 35	8 mm wide WEF 1 /35	Z5.523.9353.0	100
End clamp TS 35 with marking facilities	17,5 mm wide WEF 1 BS /35	69.920.1053.0	100
End clamp TS 35 with marking facilities	8 mm wide WEF 1 BSS /35	69.920.1253.0	100



ACCESSORIES	Type	Part No.	Std. Pack
Marking tag for WEF 1 /35	wide BS/R	Z4.243.8453.0	100
Marking cardboard in perforated sheets	100 tags/sh.	04.019.0289.0	10
Marking tag for WEF 1 /35	small	04.243.8550.0	10
Marking cardboard in perforated sheets	small	04.019.1189.0	10



END CLAMP FOR TS 35 SCREW MOUNTING

Description	Type	Part No.	Std. Pack
End clamp TS 35	8 mm wide 9708/2 S 35	Z5.522.8553.0	100
End clamp TS 35 with marking facilities	17,5 mm wide 9708/2 BS 35	69.920.0553.0	100



ACCESSORIES	Type	Part No.	Std. Pack
Marking cardboard in perforated sheets	100 tags/sh.	04.019.0289.0	10



ACCESSORIES · END BRACKETS / BUSBAR SUPPORT

END CLAMP WITH WITH U-FOOT SCREW MOUNTING



Description	Type	Part No.	Std. Pack
End clamp with U-foot	10 mm wide WE 1 /U	Z5.523.5753.0	100
End clamp with U-foot with marking facilities	17,5 mm wide WE 2 BS /U	69.920.0653.0	100

ACCESSORIES	Type	Part No.	Std. Pack
Marking cardboard in perforated sheets	100 tags/sh.	04.019.0289.0	10

END CLAMP FOR TS 15 SCREW MOUNTING



Description	Type	Part No.	Std. Pack
End clamp, plastic	7,5 mm wide 9208 S 15	Z5.522.7553.0	100
End clamp, steel	5 mm wide 9222 S 15	Z5.522.5010.0	100

BUSBAR SUPPORT FOR N-BUSBAR FASTENING, SCREWLESS

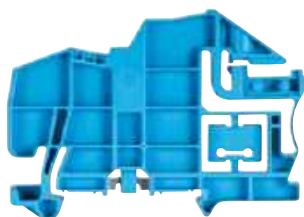

Description	Type	Part No.	Std. Pack
End bracket/busbar support	8 mm wide WKIF SH/E/35 *	Z1.108.8453.0	100

ACCESSORIES	Type	Part No.	Std. Pack
Marking tag for WKIF SH/E/35	Wide BS/R	Z4.243.8453.0	100
Label carton in perf. sheets	Wide	04.019.0289.0	10
Marking tag	Narrow	04.243.8550.0	10
Label carton in perf. sheets	Narrow	04.019.1189.0	10

* Distance between WKIF SH and WKIF SH max. 200 mm

Description	Type	Part No.	Std. Pack
Busbar support	2 mm wide WKIF SH/35	01.108.7653.0	10
Fits installation terminals WKIF and WKIS			



WIEPRINT – THE PRINTER FOR ALL CURRENT MARKING SYSTEMS

Individual marking – at Wieland, that means wieprint, is a high performance marking system with which you can professionally create labels, from individual marking tags to serial marking, for your strip terminals.

But wieprint offers still more! In addition to marking tags for series terminals, you can also print stickers, labels, or cable markings for all applications in the control cabinet.



- + Extremely versatile use
- + Prints marking tags efficiently and individually
- + Simple operation

WIEPRINT – ACCESSORIES



EXTREMELY VERSATILE USE

- For all Wieland series terminals
- For many other brands
- For identifying cables, switching elements, pushbuttons and many other control cabinet components



SIMPLE OPERATION

- High performance marking software
- Operation via software interface or directly on device
- Integrated LCD display
- Easy to maintain – just change the printing ribbons



PRINTS MARKING TAGS EFFICIENTLY AND INDIVIDUALLY

- Thermal transfer print for high quality, durable marking
- High print speed – up to 8500 tags/hour
- Automatic operation, including magazine, possible

ACCESSORIES · THERMAL TRANSFER PRINTER

THERMAL TRANSFER PRINTER WIEPRINT



Description	Typ	Part No.	Std. Pack
Complete package	wieprint	95.503.0000.0	1

Scope of delivery: Thermal transfer printer wieprint, 1 x power supply cable, 1 x USB 2.0 cable, 1 x printer ribbon black, 1 x cleaning ribbon, 1 x holding plate, Reihenklemmen P0*

Description: wieprint the printer system for marking DIN rail terminal blocks an other marking tags in the control cabinet.

Software and manual available at: www.wieland-electric.com/en/service

TECHNICAL DATA

Printing method	Thermo transfer
Operating modes	Automatic, semi-automatic, manual feed
Resolution	300 dpi
Dimensions	423 x 240 x 208 mm
Weight	9.5 kg
Fonts	Windows True Type
Graphics formats	.gif, .jpg, .jpeg, .bmp, .wmf
Printing speed	up to 60 mm/s
Interface	USB 2.0
Voltage	100V to 240V AC, 50/60Hz
Power, max.	135 W

ACCESSORIES FOR THERMAL TRANSFER PRINTERS WIEPRINT



Description	Typ	Part No.	Std. Pack
Accessories for thermal transfer printers wieprint			
Printer ribbon black (l = 130 m)	wieprint FB sw	95.503.0010.1	3
Printer ribbon red (l = 130 m)	wieprint FB rt	95.503.0010.5	3
Cleaning ribbon (l = 8 m)	wieprint RB	95.503.0012.0	1
Cleaning roll	wieprint RR	95.503.0013.0	1
Holding plate wire/cable marking, directly printable	wieprint P3	95.503.0014.0	1
Magazine for automatic mode	wieprint MAG	95.503.0005.0	1
Holding plate wire marking / Marking sleeves	wieprint P1	95.503.0006.0	1
Support base for printing system	wieprint SB	95.503.0004.0	1

ACCESSORIES · MARKING OF DIN RAIL TERMINAL BLOCKS

MARKING TAGS FOR DIN RAIL TERMINAL BLOCKS



Description	Typ	Part No.	Std. Pack	
Marking tags for DIN rail terminal blocks, unmarked				
Size 3.5 x 9.1 mm	WMP 3,5 SI2KTB3590DW	04.403.0056.0	12	
Size 5.0 x 8.5 mm	WMP 5 SI2KTB5085DW	04.405.0056.0	12	
Size 6.0 x 8.5 mm	WMP 6 SI2KTB6085DW	04.406.0056.0	12	
Size 6.0 x 10 mm	WMP 6 SI2KTB6010DW	04.406.0156.0	12	
Size 8.0 x 8.5 mm	WMP 8 SI2KTB8085DW	04.408.0056.0	12	
TECHNICAL DATA				
	3,5 x 9,1 mm	5.0 x 8.5 mm	6.0 x 8.5 mm/10 mm	8.0 x 8.5 mm
Width mm	3.5	5 and 10	6 and 12	8 and 16
Number of tags / plate	75	45	45	25
Packing unit plates / box	12	12	12	12

MARKING STRIPS FOR DIN RAIL TERMINAL BLOCKS



Description	Typ	Part No.	Std. Pack
Marking strips for DIN rail terminal blocks			
for series WTP 1.5	WMP 3,5 S-SI2K09105W	04.400.0281.2	20
for series WKF 1.5	WMS SI2K06130W	04.400.0081.2	20
TECHNICAL DATA			
Number of strips / plate	3		
Packing unit plates / box	20		

MARKING TAGS FOR DIN RAIL TERMINAL BLOCKS WEIDMÜLLER / WAGO



Description	Typ	Part No.	Std. Pack
Marking tags for DIN rail terminal blocks, unmarked, Weidmüller / Wago			
Size 5 x 10 mm	WMP SI2KTB5010LWK	04.405.1056.0	12
TECHNICAL DATA			
Number of tags / plate	45		
Packing unit plates / box	12		

MARKING TAGS FOR DIN RAIL TERMINAL BLOCKS PHOENIX CONTACT



Description	Typ	Part No.	Std. Pack
Marking tags for DIN rail terminal blocks, unmarked, Phoenix Contact			
Size 5 x 9 mm	WMP SI2KTB5209EW	04.405.1156.0	12
Size 5 x 10 mm	WMP SI2KTB5210CW	04.405.1256.0	12
TECHNICAL DATA			
Number of tags / plate	45		
Packing unit plates / box	12		



ACCESSORIES · MARKING FOR WIRES

MARKING SLEEVES



Description	Typ	Part No.	Std. Pack
Marking sleeves, push-fit			
Wire diameters 1.5 – 2.5 mm	WMS 201/15	04.410.0181.0	1000
Wire diameters 2 – 4 mm	WMS 202/15	04.410.0281.0	1000
Wire diameters 4 – 7 mm	WMS 203/15	04.410.0381.0	500
Wire diameters 6 – 10 mm	WMS 204/15	04.410.0481.0	500
Wire diameters 8 – 14 mm	WMS 205/15	04.410.0581.0	200
Marking sleeves, snap-on			
Wire diameters 2 – 3.5 mm	WMS 301/15	04.410.0681.0	1000
Wire diameters 2.8 – 5 mm	WMS 302/15	04.410.0781.0	1000
Wire diameters 5 – 8 mm	WMS 303/15	04.410.0881.0	500
Wire diameters 8 – 10 mm	WMS 304/15	04.410.0981.0	500
Technical data			
Material	PVC		
Color		transparent	
Length mm	15		

MARKING TAGS FOR WIRE MARKERS, UNMARKED



Description	Typ	Part No.	Std. Pack
Marking tags for wire markers, unmarked			
Size 15 x 4 mm, color white	WMS Si2K02W/15N	04.410.1081.2	32
Size 15 x 4 mm, color yellow	WMS Si2K02Y/15N	04.410.1081.8	32
TECHNICAL DATA			
Material	PC / ABS		
Number of tags / plate	24		
Packing unit plates / box	32		

WIRE MARKERS



Description	Typ	Part No.	Std. Pack
Wire markers, directly printable			
Wire diameters 1 – 3.8 mm	WMS Si2KTM02W/10	04.410.1281.2	22
TECHNICAL DATA			
Color	white		
Material	PC		
Length mm	10		
Number of tags / plate	33		
Packing unit plates / box	22		

ACCESSORIES · MARKING FOR CABLES

CABLE MARKING

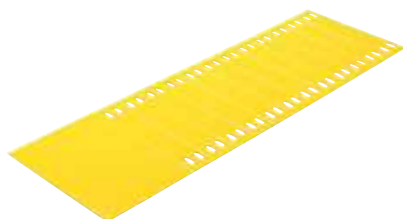

Description	Typ	Part No.	Std. Pack
Cable marking, unmarked			
Size: 15 x 80 mm, directly printable, color yellow	WMS SI2KCT1580Y	04.410.1481.8	15
TECHNICAL DATA			
Material	PVC		
Number of tags / plate	12		
Packing unit plates / box	15		

MARKING SLEEVES



Description	Typ	Part No.	Std. Pack
Marking sleeves			
Size 7 x 46 mm, color transparent	WMS SIT0003X050	04.410.1581.0	224
Size 15 x 67 mm, color transparent	WMS SIT0004X070	04.410.1781.0	96
Size 9 x 20 mm, color transparent	WMS SI1001	04.410.1981.0	240
TECHNICAL DATA			
Material	PVC		

MARKING TAGS



Description	Typ	Part No.	Std. Pack
Marking tags for marking sleeves			
Size 7 x 46, color white	WMS SI2K0746W	04.410.1681.2	40
Size 15 x 67, color white	WMS SI2K1567W	04.410.1881.2	25
Size 9 x 20 mm, color white	WMS SI2K1001W	04.410.2081.2	40
Size 9 x 20 mm, color yellow	WMS SI2K1001Y	04.410.2081.8	40
TECHNICAL DATA			
	7 x 46 mm	15 x 67 mm	9 x 20 mm
Material	PVC		
Number of tags / plate	28	4	60
Packing unit plates / box	40	25	40



ACCESSORIES · MARKING FOR DEVICES

MARKING TAGS



Description	Typ	Part No.	Std. Pack		
Marking tags, blank					
Size 7 x 20 mm, color white	WMS SI2K40720W	04.420.0181.2	25		
Size 7 x 20 mm, color yellow	WMS SI2K40720Y	04.420.0181.8	25		
Size 8 x 17 mm, color white	WMS SI2K40817W	04.420.0381.2	25		
Size 9 x 20 mm, color white	WMS SI2K40920W	04.420.0481.2	25		
Size 9 x 35 mm, color white	WMS SI2K40935W	04.420.0581.2	25		
Size 10 x 25 mm, color white	WMS SI2K41025W	04.420.0681.2	20		
TECHNICAL DATA					
	7 x 20 mm	8 x 17 mm	9 x 20 mm	9 x 35 mm	10 x 25 mm
Material	PVC				
Number of tags / plate	70	77	60	36	30
Packing unit plates / box	25	25	25	25	20

MARKING ADHESIVE LABEL



Description	Typ	Part No.	Std. Pack	
Marking adhesive label, unmarked				
Size 6 x 15 mm, color white	WMS SI2KFX0615W	04.420.1581.2	52	
Size 6 x 15 mm, color yellow	WMS SI2KFX0615Y	04.420.1581.8	52	
Size 7 x 20 mm, color white	WMS SI2KFX0720W	04.420.1681.2	50	
Size 7 x 20 mm, color yellow	WMS SI2KFX0720Y	04.420.1681.8	50	
Size 9 x 15 mm, color white	WMS SI2KFX0915W	04.420.1781.2	45	
Size 9 x 15 mm, color yellow	WMS SI2KFX0915Y	04.420.1781.8	45	
Size 22 x 22 mm, color white	WMS SI2KFX2222W	04.420.1881.2	50	
TECHNICAL DATA				
	6 x 15 mm	7 x 20 mm	9 x 15 mm	22 x 22 mm
Material	Vinyl			
Number of tags / plate	117	70	78	16
Packing unit plates / box	52	50	45	50

ACCESSORIES · MARKING FOR CONTROL CABINET AND BUTTONS

TYPE PLATES FOR CONTROL CABINET

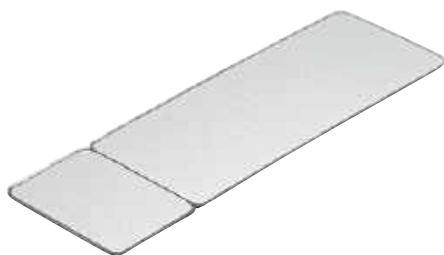

Description	Typ	Part No.	Std. Pack
Type plates, PVC, unmarked			
Size 30 x 70 mm, color white	WMS SI2K43070W	04.420.0781.2	20
Size 30 x 70 mm, color metallic	WMS SI2K43070M	04.420.0781.0	20
Size 30 x 70 mm, color yellow	WMS SI2K43070Y	04.420.0781.8	20
Size 60 x 100 mm, color white	WMS SI2K460100W	04.420.1081.2	15
Size 60 x 100 mm, color metallic	WMS SI2K460100M	04.420.1081.0	15
Size 60 x 100 mm, color yellow	WMS SI2K460100Y	04.420.1081.8	15
TECHNICAL DATA			
Material	PVC		
Number of tags / plate	1		

MARKING FOR TYPE PLATES

- holder for marking tags
- marking tag



Description	Typ	Part No.	Std. Pack
Marking for type plates			
Holder for marking tags	WMS SIT0B05	04.420.1381.0	192
Marking tag size 15 x 27 mm	WMS SI2K1527W	04.420.1481.2	11
TECHNICAL DATA			
Material	PVC		
Number of tags / plate	18		
Packing unit plates / box	11		

MARKING TAG

- for button
- adhesive label



Description	Typ	Part No.	Std. Pack
Marking tag for the button			
adhesive label size 15 x 27 mm, color white	WMS SI2K41527W	04.420.1281.2	11
adhesive label size 15 x 27 mm, color metallic	WMS SI2K41527M	04.420.1281.0	11
TECHNICAL DATA			
Material	PVC / ACR		
Number of tags / plate	18		
Packing unit plates / box	11		



WIEPLOT – THE POWERFUL MARKING SYSTEM

Together with the wieplot plotter you have a powerful marking system that enables you to work professionally from the individual marking tag to series marking of your terminal block assemblies. You feel confident with the system due to its easy handling and visual representation of your marking, even when you use it for the first time. But wieplot offers even more! In addition to the marking tags for DIN rail terminal blocks you can also print self-adhesive tags and labels or cable markings. A slight modification can even make your plotter a powerful engraving system.



UNIVERSAL MARKING WITH WIEPLOT

- Marks all common marking systems available for DIN rail terminal blocks
- Different marking tags can be marked individually in one single work step
- Marking of labels, self-adhesive tags and cables is possible



DURABLE AND SAFE MARKING WITH ENGRAVING SYSTEM WIEPLOT

- Easy modification to wieplot to make it an engraving system
- Engraving of multi-layer plastic boards
- Clean and dust-proof operation due to integrated vacuum device
- Create individual layouts



THE INTUITIVE LABELLING SOFTWARE: EASY AND QUICK TO CONFIGURE

- Simple and intuitive user interface
- Direct graphical display of the marking tags including plausibility check
- Customized layouts can be created individually
- Data import from CAD, Excel, text or wieplan

ACCESSORIES · THE PLOTTER SYSTEM WIEPLOT + WIEPLOT BASIC

PLOTTER SYSTEM



WIEPLOT BASIC

Description	Type	Part No.	Std. Pack
Complete package	wieplot BASIC	95.502.0607.0	1
Complete package	wieplot	95.502.0604.0	1

Contents: Plotter wieplot, data cable and manual, 4 receptacles (wieplot) / 2 receptacles (wieplot BASIC) for WSB (Wieland standard marking system), accessories kit, software

TECHNICAL DATA

Resolution	0.01 mm
Accuracy	+ / - 0.05 mm
Power supply unit	50 / 60 Hz, 100 - 240 V
Output voltage	24 VDC 1.4 A
Current input	app. 0.3 A at 220 V
Approval	UL-UL1950, CSA 950, VDE EN 60950
Radio interf. suppr.	FCC class B, FCC sect. 15 and VDE class B
Dimension / Weight – wieplot BASIC	440 mm x 440 mm x 125 mm / 6 kg
Dimension / Weight – wieplot	660 mm x 440 mm x 125 mm / 8 kg
Interfaces	USB Level 1.1, parallel

ACCESSORIES FOR WIEPLOT



Plotter pens for wieplot	Part No.	Type	Part No.
Plotter pen 0.18 mm	95.502.0118.0	Ink cartridge P2.0, 5x1ml	95.502.0199.0
Plotter pen 0.25 mm	95.502.0125.0	Cleaning set	95.502.0198.0
Plotter pen 0.35 mm	95.502.0135.0	Pen cleaner	95.502.0197.0
Plotter pen 0.50 mm	95.502.0150.0	Dust protection hood	95.502.0612.0
Plotter pen 0.70 mm	95.502.0170.0	Service kit – pen station	95.502.0613.0
Plotter pen 1.00 mm	95.502.0100.0	Seal inserts kit	
Dispos plotter pen 0.25 mm	95.502.0125.1		
Dispos plotter pen 0.35 mm	95.502.0135.1		
Dispos plotter pen-D ED 0.25 mm	95.502.0225.1		
Dispos plotter pen-D ED 0.35 mm	95.502.0235.1		

Receptacles for marking plates	
Type	Part No.
Receptacle for WSB	95.502.0620.0
Receptacle for BZ/WKF 15,	95.502.0627.0
Receptacle for BZ/WKF 1,5/10	95.502.0628.0

ENGRAVING UNIT FOR WIEPLOT



Description	Type	Part No.	Std. Pack
Engraving unit	wieplot E-UNIT	95.502.0700.0	1

Contents: Engraving spindle, engraving head (with fuse and counter bearing), control unit wieplot VEC, vacuum cleaner wieplot VC, connection cables

Description:

The system is set up for engraving multi-layer plastic tags. The Plotboard A4 in a 297 x 202 mm format is the receptacle for marking paper sheets and labels and also enables engraving of plastic boards.

ACCESSORIES	Type	Part No.	Std. Pack
Graver SET, complete	SET	95.502.0710.0	1
Graver	0.2 mm	95.502.0710.2	1
Graver	0.3 mm	95.502.0710.3	1
Graver	0.4 mm	95.502.0710.4	1
Graver	0.5 mm	95.502.0710.5	1
Graver	0.7 mm	95.502.0710.7	1
Graver	1.0 mm	95.502.0711.0	1
Receptacle	Plottboard A4	95.502.0625.0	1

MARKING PLATES

• For wieplot



Description	Type	Part No.	Std. Pack
Unmarked			
Width 3.5 x 9 mm*	120 tags per plate	WMP 3,5 S-SI2K09105W	04.400.0281.2 20
Width 4 x 5 mm	100 tags per plate	9705 4/10/10	Z4.243.2053.0 10
Width 5 x 8.3 mm	110 tags per plate	9705 A/5/10/11	Z4.242.5053.0 10
Width 5 x 14 mm	60 tags per plate	9705 AL/5/10/6	Z4.242.5153.0 10
Width 6 x 8.3 mm	110 tags per plate	9705 A/6/10/11	Z4.242.6053.0 10
Width 6 x 14 mm	60 tags per plate	9705 AL/6/10/6	Z4.242.6353.0 10
Width 8 x 8.3 mm	70 tags per plate	9705 A/8/10/7	Z4.242.8053.0 10

* Receptacle plate on request

ACCESSORIES · MARKING ACCESSORIES

SINGLE MARKING TAG ALL BLOCKS/ 5 MM WIDE AND LARGER

^{*)} Custom marking upon request



Description	Type	Part No.	Std. Pack
Unmarked			
Width 5 x 8.3 mm	9705 A	04.242.0850.0	500
Width 5 x 14 mm	9705 AL	04.242.1553.0	500
Marked			
Width 5 x 8.3 mm	9705 AB ^{*)}	04.842.0850.0	500
Width 5 x 14 mm	9705 ALB ^{*)}	04.842.1553.0	500

MARKING STRIPS WTP 1.5 MM²/3.5 MM WIDE

^{*)} Custom marking upon request



Description	Type	Part No.	Std. Pack
Marked			
^{*)}	WMP 3,5 / B ^{*)}	04.543.0056.0	10
1 - 15 (5x)	WMP 3,5 / B 1 - 15	04.543.0156.0	10
16 - 30 (5x)	WMP 3,5 / B 16 - 30	04.543.0256.0	10
31 - 45 (5x)	WMP 3,5 / B 31 - 45	04.543.0356.0	10
46 - 60 (5x)	WMP 3,5 / B 46 - 60	04.543.0456.0	10
61 - 75 (5x)	WMP 3,5 / B 61 - 75	04.543.0556.0	10
76 - 90 (5x)	WMP 3,5 / B 76 - 90	04.543.0656.0	10
91 - 105 (5x)	WMP 3,5 / B 91 - 105	04.543.0756.0	10
106 - 120 (5x)	WMP 3,5 / B 106 - 120	04.543.0856.0	10
121 - 135 (5x)	WMP 3,5 / B 121 - 135	04.543.0956.0	10
136 - 150 (5x)	WMP 3,5 / B 136 - 150	04.543.1056.0	10
⊕ (5x)	WMP 3,5 / B SLZ	04.553.0056.0	25
⊖ (5x)	WMP 3,5 / B ERDZ	04.553.0156.0	25
+ (5x)	WMP 3,5 / B +	04.553.0256.0	25
- (5x)	WMP 3,5 / B -	04.553.0356.0	25
L1 (5x)	WMP 3,5 / B L1	04.553.0456.0	25
L2 (5x)	WMP 3,5 / B L2	04.553.0556.0	25
L3 (5x)	WMP 3,5 / B L3	04.553.0656.0	25
PE (5x)	WMP 3,5 / B PE	04.553.0756.0	25
SL (5x)	WMP 3,5 / B SL	04.553.3156.0	25
N (5x)	WMP 3,5 / B N	04.553.3256.0	25
F1 (5x)	WMP 3,5 / B F1	04.553.0956.0	25
F2 (5x)	WMP 3,5 / B F2	04.553.1056.0	25
L1,L2,L3,N,PE (5x)	WMP 3,5 / B L1L2L3NPE..	04.553.0856.0	25

MARKING STRIPS WKF 1.5 MM²/4 MM WIDE

^{*)} Custom marking upon request



Description	Type	Part No.	Std. Pack
Marking strips for center block marking			
Unmarked	BZ/WKF 1,5	04.243.2053.0	100
Marked	BZ/WKF 1,5 B	04.843.2053.0	25
Marking strips for outer block marking			
Marked	9705 A 4/10/10	Z4.243.2053.0	10

MARKING STRIPS 2.5 MM²/5 MM WIDE

^{*)} Custom marking upon request



Description	Type	Part No.	Std. Pack
Unmarked			
	9705 A/5/10	04.242.5053.0	25
Marked			
1 - 9	9705A/5/9 B 1 - 9	04.842.4953.0	25
^{*)}	9705A/5/10 B	04.842.5053.0	25
1 - 10	9705A/5/10 B 1 - 10	04.845.0153.0	25
11 - 20	9705A/5/10 B 11 - 20	04.845.0253.0	25
21 - 30	9705A/5/10 B 21 - 30	04.845.0353.0	25
31 - 40	9705A/5/10 B 31 - 40	04.845.0453.0	25
41 - 50	9705A/5/10 B 41 - 50	04.845.0553.0	25
51 - 60	9705A/5/10 B 51 - 60	04.845.0653.0	25
61 - 70	9705A/5/10 B 61 - 70	04.845.0753.0	25
71 - 80	9705A/5/10 B 71 - 80	04.845.0853.0	25
81 - 90	9705A/5/10 B 81 - 90	04.845.0953.0	25
91 - 100	9705A/5/10 B 91 - 100	04.845.1053.0	25
⊕ (10x)	9705A/5/10B SLZ	04.855.0053.0	25
⊖ (10x)	9705A/5/10B ERDZ	04.855.0153.0	25
+ (10x)	9705A/5/10 B +	04.855.0253.0	25
- (10x)	9705A/5/10 B -	04.855.0353.0	25
L1 (10x)	9705A/5/10B L1	04.855.0453.0	25
L2 (10x)	9705A/5/10B L2	04.855.0553.0	25
L3 (10x)	9705A/5/10B L3	04.855.0653.0	25
PE (10x)	9705A/5/10B PE	04.855.0753.0	25
SL (10x)	9705A/5/10B SL	04.855.3153.0	25
N (10x)	9705A/5/10B N	04.855.3253.0	25
F1 (10x)	9705A/5/10B F1	04.855.0953.0	25
F2 (10x)	9705A/5/10B F2	04.855.1053.0	25
L1,L2,L3,N,PE (10x)	9705A/5/10B L1L2L3NPE..	04.855.0853.0	25
With enlarged marking area			
	9705 AL/5/10	04.242.5153.0	25

MARKING STRIPS 4 MM²/6 MM WIDE

*) Custom marking upon request



Description	Type	Part No.	Std. Pack
Unmarked	9705 A/6/10	04.242.6053.0	25
Marked	1 - 9	9705A/6/9 B 1 - 9	04.842.5953.0
	*)	9705A/6/10 B	04.842.6053.0
	1 - 10	9705A/6/10 B 1 - 10	04.846.0153.0
	11 - 20	9705A/6/10 B 11 - 20	04.846.0253.0
	21 - 30	9705A/6/10 B 21 - 30	04.846.0353.0
	31 - 40	9705A/6/10 B 31 - 40	04.846.0453.0
	41 - 50	9705A/6/10 B 41 - 50	04.846.0553.0
	51 - 60	9705A/6/10 B 51 - 60	04.846.0653.0
	61 - 70	9705A/6/10 B 61 - 70	04.846.0753.0
	71 - 80	9705A/6/10 B 71 - 80	04.846.0853.0
	81 - 90	9705A/6/10 B 81 - 90	04.846.0953.0
	91 - 100	9705A/6/10 B 91 - 100	04.846.1053.0
	⊕ (10x)	9705A/6/10 B SLZ	04.856.0053.0
	⊖ (10x)	9705A/6/10 B ERDZ	04.856.0153.0
	+ (10x)	9705A/6/10 B +	04.856.0253.0
	- (10x)	9705A/6/10 B -	04.856.0353.0
	L1 (10x)	9705A/6/10 B L1	04.856.0453.0
	L2 (10x)	9705A/6/10 B L2	04.856.0553.0
	L3 (10x)	9705A/6/10 B L3	04.856.0653.0
	PE (10x)	9705A/6/10 B PE	04.856.0753.0
	SL (10x)	9705A/6/10 B SL	04.856.3153.0
	N (10x)	9705A/6/10 B N	04.856.3253.0
	F1 (10x)	9705A/6/10 B F1	04.856.0953.0
	F2 (10x)	9705A/6/10 B F2	04.856.1053.0
	L1,L2,L3,N,PE (10x)	9705A/6/10 B L1L2L3NPE..	04.856.0853.0
With enlarged marking area	9705 AL/6/10	04.242.6353.0	25

MARKING STRIPS 6 MM²/8 MM WIDE

*) Custom marking upon request



Description	Type	Part No.	Std. Pack
Unmarked	9705 A/8/10	04.242.8053.0	25
Marked	1 - 9	9705A/8/9 B 1 - 9	04.842.7953.0
	*)	9705A/8/10 B	04.842.8053.0
	1 - 10	9705A/8/10 B 1 - 10	04.848.0153.0
	11 - 20	9705A/8/10 B 11 - 20	04.848.0253.0
	21 - 30	9705A/8/10 B 21 - 30	04.848.0353.0
	31 - 40	9705A/8/10 B 31 - 40	04.848.0453.0
	41 - 50	9705A/8/10 B 41 - 50	04.848.0553.0
	51 - 60	9705A/8/10 B 51 - 60	04.848.0653.0
	61 - 70	9705A/8/10 B 61 - 70	04.848.0753.0
	71 - 80	9705A/8/10 B 71 - 80	04.848.0853.0
	81 - 90	9705A/8/10 B 81 - 90	04.848.0953.0
	91 - 100	9705A/8/10 B 91 - 100	04.848.1053.0
	⊕ (10x)	9705A/8/10 B SLZ	04.858.0053.0
	⊖ (10x)	9705A/8/10 B ERDZ	04.858.0153.0
	+ (10x)	9705A/8/10 B +	04.858.0253.0
	- (10x)	9705A/8/10 B -	04.858.0353.0
	L1 (10x)	9705A/8/10 B L1	04.858.0453.0
	L2 (10x)	9705A/8/10 B L2	04.858.0553.0
	L3 (10x)	9705A/8/10 B L3	04.858.0653.0
	PE (10x)	9705A/8/10 B PE	04.858.0753.0
	SL (10x)	9705A/8/10 B SL	04.858.3153.0
	N (10x)	9705A/8/10 B N	04.858.3253.0
	F1 (10x)	9705A/8/10 B F1	04.858.0953.0
	F2 (10x)	9705A/8/10 B F2	04.858.1053.0
	L1,L2,L3,N,PE (10x)	9705A/8/10 B L1L2L3NPE..	04.858.0853.0

MARKING STRIPS 10 MM²/10 MM WIDE 16 MM²/12 MM WIDE 35 MM²/16 MM WIDE 70 MM²/24 MM WIDE



Description	Type	Part No.	Std. Pack
10 mm²/10 mm wide for 5 blocks	9705 A/5/10/5 B	04.842.5553.0	25
16 mm²/12 mm wide for 5 blocks	9705 A/6/10/5 B	04.842.6553.0	25
35 mm²/16 mm wide for 5 blocks	9705 A/8/10/5 B	04.842.8553.0	25
70 mm²/24 mm wide for 4 blocks	9705 A/8/10/5 B	04.842.8553.0	25

Specify required marking with part no.

ACCESSORIES · MARKING ACCESSORIES

TEAR-OFF MARKING STRIPS MARKED WITH NUMBERS

- With 10 marking tags
- For single symbol marking



Description	Type	Part No.	Std. Pack
Unmarked	9704 A	04.241.1150.0	25
Marked with the same number			
1	9704 A/1 B	04.841.1150.0	25
2	9704 A/2 B	04.841.1250.0	25
3	9704 A/3 B	04.841.1350.0	25
4	9704 A/4 B	04.841.1450.0	25
5	9704 A/5 B	04.841.1550.0	25
6	9704 A/6 B	04.841.1650.0	25
7	9704 A/7 B	04.841.1750.0	25
8	9704 A/8 B	04.841.1850.0	25
9	9704 A/9 B	04.841.1950.0	25
0	9704 A/0 B	04.841.2050.0	25
Marked with consecutive numbers			
1-0	9704 A/1-0 B	04.841.2150.0	25
Marked with the same symbols			
+	9704 A/+	04.841.7450.0	25
-	9704 A/-	04.841.7550.0	25
/	9704 A//	04.841.7650.0	25
.	9704 A/.	04.841.7750.0	25
Set, marked with same numbers (= 10 x 25 strips = 2.500 numbers)			
111 up to 000		04.841.9050.0	1

TEAR-OFF MARKING STRIPS MARKED WITH UPPER CASE LETTERS

- With 10 marking tags
- For single symbol marking



Description	Type	Part No.	Std. Pack
Marked with the same upper case letters			
A	9704 A /AG B	04.841.2250.0	25
B	9704 A /BG B	04.841.2350.0	25
C	9704 A /CG B	04.841.2450.0	25
D	9704 A /DG B	04.841.2550.0	25
E	9704 A /EG B	04.841.2650.0	25
F	9704 A /FG B	04.841.2750.0	25
G	9704 A /GG B	04.841.2850.0	25
H	9704 A /HG B	04.841.2950.0	25
I	9704 A /IG B	04.841.3050.0	25
J	9704 A /JG B	04.841.3150.0	25
K	9704 A /KG B	04.841.3250.0	25
L	9704 A /LG B	04.841.3350.0	25
M	9704 A /MG B	04.841.3450.0	25
N	9704 A /NG B	04.841.3550.0	25
O	9704 A /OG B	04.841.3650.0	25
P	9704 A /PG B	04.841.3750.0	25
Q	9704 A /QG B	04.841.3850.0	25
R	9704 A /RG B	04.841.3950.0	25
S	9704 A /SG B	04.841.4050.0	25
T	9704 A /TG B	04.841.4150.0	25
U	9704 A /UG B	04.841.4250.0	25
V	9704 A /VG B	04.841.4350.0	25
W	9704 A /WG B	04.841.4450.0	25
X	9704 A /XG B	04.841.4550.0	25
Y	9704 A /YG B	04.841.4650.0	25
Z	9704 A /ZG B	04.841.4750.0	25
Set, marked with same upper case letters (= 26 x 25 strips = 6.500 numbers)			
A up to Z GB		04.841.9150.0	1

ASSORTMENT BOX

- For marking material



Description	Type	Part No.	Std. Pack
Assortment box for 5 mm width	S0 1/5	04.900.2053.0	1
Assortment for 5 mm width	1-100	9705 A/5/10 B	04.855.1153.0
	101-200	9705 A/5/10 B	04.855.1253.0
Assortment box for 6 mm width	S0 1/6	04.900.3053.0	1
Assortment for 6 mm width	1-100	9705 A/6/10 B	04.856.1153.0
	101-200	9705 A/6/10 B	04.856.1253.0
Assortment box for 8 mm width	S0 1/8	04.900.4053.0	1
Assortment for 8 mm width	1-100	9705 A/8/10 B	04.858.1153.0
	101-200	9705 A/8/10 B	04.858.1253.0
Assortment box for tear-off marking tags with 50 digits each	S0 1/0	04.900.1053.0	1
Assortment box, empty	S0 1	04.900.0000.0	1

MARKING TAG CARRIER

- For all blocks



Description	Type	Part No.	Std. Pack
Marking tag carrier, 4 digits	9705 A/4	04.242.0950.0	200
Marking tag carrier, 6 digits	9705 A/6	04.242.1250.0	200
Marking tag carrier, 45° angle	9705 A/4 W	04.242.2853.0	200

PARTITION

- With marking facilities



Description	Type	Part No.	Std. Pack
Partition with carrier for marking tags for TS 32 and TS 35		Z7.311.1755.0	10
Partition with carrier for marking cards for TS 32 and TS 35		Z7.311.7055.0	10
Accessories Marking card in perforated sheets	100 tags/sheets	04.019.0289.0	10

ACCESSORIES · CROSS CONNECTORS AND JUMPER BARS

CROSS CONNECTORS

- Cross connector poles can be individually removed.
- When cross connectors with removed poles are used, the rated voltage is reduced to 400 V.
- You can cut a 10-wire connector plug in half to form two 5-wire connector plugs, but an end cover plate or isolating plate must then be inserted.

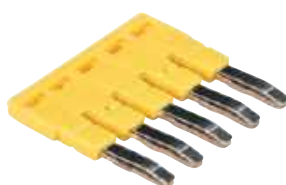

Description	Type	Part No.	Std. Pack
1.5 mm², 3 mm wide	IVB WTP 1,5-2	Z7.284.7027.0	10
	IVB WTP 1,5-3	Z7.284.7127.0	10
	IVB WTP 1,5-4	Z7.284.7227.0	10
	IVB WTP 1,5-5	Z7.284.7327.0	10
	IVB WTP 1,5-10	Z7.284.7427.0	10
1.5 mm², 4 mm wide	IVB WKF 1,5-2	Z7.268.0227.0	10
	IVB WKF 1,5-3	Z7.268.0327.0	10
	IVB WKF 1,5-4	Z7.268.0427.0	10
	IVB WKF 1,5-5	Z7.268.0527.0	10
	IVB WKF 1,5-10	Z7.268.1027.0	10
2.5 mm², 5 mm wide	IVB WKF 2,5-2	Z7.280.6227.0	10
	IVB WKF 2,5-3	Z7.280.6327.0	10
	IVB WKF 2,5-4	Z7.280.6427.0	10
	IVB WKF 2,5-5	Z7.280.6527.0	10
	IVB WKF 2,5-6	Z7.280.6627.0	10
	IVB WKF 2,5-7	Z7.280.6727.0	20
	IVB WKF 2,5-8	Z7.280.6827.0	20
	IVB WKF 2,5-9	Z7.280.6927.0	20
	IVB WKF 2,5-10	Z7.280.7027.0	20
	IVB WKF 2,5-20	Z7.280.8027.0	20
	IVB WKF-V	Z7.261.1127.0	10
4 mm², 6 mm wide	IVB WKF 4-2	Z7.261.1227.0	10
	IVB WKF 4-3	Z7.261.1327.0	10
	IVB WKF 4-4	Z7.261.1427.0	10
	IVB WKF 4-5	Z7.261.1527.0	10
	IVB WKF 4-6	Z7.261.1627.0	10
	IVB WKF 4-7	Z7.261.1727.0	10
	IVB WKF 4-8	Z7.261.1827.0	10
	IVB WKF 4-9	Z7.261.1927.0	10
	IVB WKF 4-10	Z7.261.2027.0	10
	IVB WKFN 6-2	Z7.282.5227.0	10
IVB WKFN 6-5	Z7.282.5527.0	10	
10 mm², 10 mm wide	IVB WKF 10-2	Z7.283.8227.0	10
16 mm², 12 mm wide	IVB WKF 16-2	Z7.284.4227.0	10
35 mm², 16 mm wide	IVB WKF 35-2	Z7.285.6227.0	10
	IVB WKF 35R10-2	Z7.285.6427.0	10
Jumping cross connectors for WT 2,5, WTP 2,5/4 and WKFN 2,5			
3-pole 1-3		99.013.9999.9	10
4-pole 1-4		99.014.9999.9	10
5-pole 1-5		99.015.9999.9	10
5-pole 1 to 3 to 5		99.031.9999.9	10
7-pole 1 to 3, 5 and 7		99.032.9999.9	10
9-pole 1 to 3, 5, 7 and 9		99.033.9999.9	10
11-pole 1 to 3, 5, 7, 9 and 11		99.034.9999.9	10
Additional combinations upon request			

JUMPER BAR, INSULATED JUMPER COMB, INSULATED

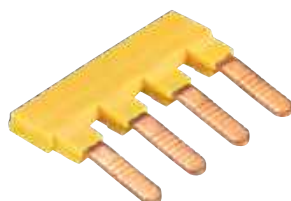

Description	Type	Part No.	Std. Pack
WK 4 /U and WK 4 TK, 6 mm wide, 0.5 mm thick			
Jumper comb, insulated	IVB 0,5 WK 4-2	Z7.255.0227.0	10
	IVB 0,5 WK 4-12	Z7.255.0227.0	10
WK 4 /U and WK 4 TK, 6 mm wide, 1 mm thick			
Jumper comb, insulated	IVB 1 WK 4-2	Z7.255.4227.0	10
	IVB 1 WK 4-12	Z7.255.4227.0	10
WK 6, WKN 6 TK, WK 4 THSi 6,3x32			
Jumper comb, insulated	IVK WKN 6 TK-2	Z7.255.8227.0	10
	IVK WKN 6 TK-3	Z7.255.8327.0	10
	IVK WKN 6 TK-4	Z7.256.8427.0	10
	IVK WKN 6 TK-5	Z7.256.8527.0	10
	IVK WKN 6 TK-6	Z7.256.8527.0	10

ACCESSORIES · COVER STRIPS AND TEST PLUGS

COVER STRIP WITH WARNING SYMBOL

- Over 4 blocks, tension spring connection



Description	Type	Part No.	Std. Pack
for tension spring connection			
1.5 mm ² , 4 mm wide	ADF 1,5/5 GELB	04.343.6953.8	10
2.5 mm ² , 5 mm wide	ADFN 2,5/4 GELB	04.343.8353.8	10
4 mm ² , 6 mm wide	ADF 4/4 GELB	04.343.6153.8	10
6 mm ² , 8 mm wide	ADF 6/4 GELB	04.343.6253.8	10
10 mm ² , 10 mm wide	ADF 10/4 GELB	04.343.6453.8	10
16 mm ² , 12 mm wide	ADF 16/4 GELB	04.343.6653.8	10
35 mm ² , 16 mm wide	ADF 35/5 GELB	04.343.9253.8	10

- Over 4 blocks, screw connection



for screw connection			
WKN 35/U, 16 mm wide, screw M5	AD 16/4 GELB	04.343.5256.8	10
WKN 70/U, 24 mm wide, screw M6	AD 24/4 GELB	04.343.5356.8	10
WKN 150/U, 28 mm wide, screw M8	ADN 28/4 GELB	04.343.5456.8	10

TEST PLUG WITH TENSION SPRING CONNECTION

- For WT/WTP/WKF... terminal blocks
- For 2.5 mm², 5 mm wide and 4 mm², 6 mm wide



Description	Type	Part No.	Std. Pack
Test plug	PSWKC/F	Z1.299.9753.0	10
Blind piece		01.299.9753.0	10
Endplate	ZP/AP PS	07.312.6053.0	10

GENERAL DATA			
Width	5 mm / 6 mm*		
Wire strip length	8 mm		
TECHNICAL DATA			
	IEC	UL	CSA
Cross section solid	0.13 – 1.5 mm ²		
Cross section fine-stranded	0.13 – 1.5 mm ²		
Rated current	13.5 A		
Rated voltage	400 V		
Note	* For 6 mm spacing a ZP/AP PS is snapped on behind each test plug or blind piece.		

TEST PLUG

- 250 V / 2 A



Description	Type	Part No.	Std. Pack
Test plug 2.3 mm red	ST 2/2 RT	Z5.553.2921.0	10
Test plug 2.3 mm black	ST 2/2 SW	Z5.553.2921.1	50
Test plug 2.3 mm blue	ST 2/2 BL	Z5.553.2921.6	100
Test plug 4 mm black	ST 2/4 SW	Z5.553.3021.0	10

ACCESSORIES · TOOLS

WIRE ENTRY GUIDES

- For conductors with cross sections smaller than 1 mm²



Description	Type	Part No.	Std. Pack
2.5 mm², 5 mm wide			
for 0.13 – 0.2 mm ² wires	LELN 2,5/1 WEISS	05.564.3755.0	100
for 0.25 – 0.5 mm ² wires	LELN 2,5/1 GRAU	05.564.3855.0	100
for 0.75 – 1.0 mm ² wires	LELN 2,5/1 SCHWARZ	05.564.3955.0	100
4 mm², 6 mm wide			
for 0.13 – 0.2 mm ² wires	LEL 4/1 WEISS	05.561.8553.0	100
for 0.25 – 0.5 mm ² wires	LEL 4/2 GRAU	05.561.8653.0	100
for 0.75 – 1.0 mm ² wires	LEL 4/3 SCHWARZ	05.561.8753.0	100

NOTCHING TOOL FOR CROSS CONNECTORS

- For 1.5 mm², wide 4 mm wide
- For 2.5 mm², 5 mm wide
- For 4 mm², 6 mm wide



Description	Type	Part No.	Std. Pack
Notching tool	AKW /A	95.300.0500.0	1

SCREWDRIVERS



Description	Type	Part No.	Std. Pack
1.5 mm², 4 mm wide			
Uninsulated, long and straight	DIN 5264 A 0,4x2,5	06.502.4300.0	5
2.5 mm², 5 mm wide			
Uninsulated, long and straight	DIN 5264 A 0,6x3,5	06.502.4000.0	10
Uninsulated, short and straight	DIN 5264 A 0,6x3,5 M	06.502.5000.0	10
Uninsulated, long and angled	DIN 5264 B 0,6x3,5 W	05.502.4100.0	10
Uninsulated, short and angled	DIN 5264 B 0,6x3,5 MW	05.502.4000.0	10
4 mm², 6 mm wide			
Uninsulated, long and straight	DIN 5264 A 0,6x3,5	06.502.4000.0	10
Uninsulated, short and straight	DIN 5264 A 0,6x3,5 M	06.502.5000.0	10
Uninsulated, long and angled	DIN 5264 B 0,6x3,5 W	05.502.4100.0	10
Uninsulated, short and angled	DIN 5264 B 0,6x3,5 MW	05.502.4000.0	10
6 mm², 8 mm wide	DIN 5264 A 0,8x4	06.502.4100.0	5
10 mm², 10 mm wide	DIN 5264 A 1x5,5	06.502.4200.0	5
16 mm², 12 mm wide	DIN 5264 A 1x5,5	06.502.4200.0	5
35 mm², 16 mm wide	DIN 5264 A 1x5,5	06.502.4200.0	5

ACCESSORIES · FERRULES AND TOOLS

FERRULES

WITH INSULATING MATERIAL SLEEVE

• Materials:

Sleeve: Polypropylene, temperature resistance 105°C, creepage resistant
 Tube: E-Cu, galvanically tin-plated



WITHOUT INSULATING MATERIAL SLEEVE

• Materials: Tube: E-Cu, galvanically tin-plated

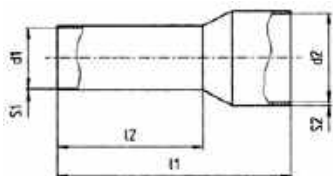

Cross section mm ²	AWG	Color	s2	d2	l1	l2	d1	s1	Part No.	Std. Pack	
Ferrules with insulating material sleeve according to DIN 46228 T4											
0.50	norm.	22 - 20 AWG	white	0.25	2.6	14	8	1.0	0.15	06.600.2027.0	500
0.75	norm.	18 AWG	gray	0.25	2.8	14	8	1.2	0.15	06.600.2127.0	500
1.00	norm.	18 AWG	red	0.25	3.0	14	8	1.4	0.15	06.600.2227.0	500
1.50	norm.	16 AWG	black	0.25	3.5	14	8	1.7	0.15	06.600.2327.0	500
1.50	long	16 AWG	black	0.25	3.5	24	18	1.7	0.15	06.600.2427.0	500
2.50	norm.	14 AWG	blue	0.25	4.2	14	8	2.2	0.15	06.600.2527.0	500
2.50	long	14 AWG	blue	0.25	4.2	24	18	2.2	0.15	06.600.2627.0	500
4.00	norm.	12 AWG	gray	0.30	4.8	17	10	2.8	0.20	06.600.2727.0	500
4.00	long	12 AWG	gray	0.30	4.8	26	18	2.8	0.20	06.600.2827.0	100
6.00	norm.	10 AWG	yellow	0.30	6.3	20	12	3.5	0.20	06.600.2927.0	100
6.00	long	10 AWG	yellow	0.30	6.3	26	18	3.5	0.20	06.600.3027.0	100
10.00	norm.	8 AWG	red	0.40	7.6	22	12	4.5	0.20	06.600.3127.0	100
10.00	long	8 AWG	red	0.40	7.6	28	18	4.5	0.20	06.600.3227.0	100
16.00	norm.	6 AWG	blue	0.40	8.8	24	12	5.8	0.20	06.600.3327.0	100
16.00	long	6 AWG	blue	0.40	8.8	28	18	5.8	0.20	06.600.3427.0	100
25.00	mid-length	4 AWG	yellow	0.40	11.2	30	18	7.3	0.20	06.600.3527.0	50
Ferrules without insulating material sleeve according to DIN 46228 T1											
0.50	norm.	22 - 20 AWG			2.1	6		1.0	0.15	06.600.4027.0	1000
0.75	norm.	18 AWG			2.3	6		1.2	0.15	06.600.4127.0	1000
1.00	norm.	18 AWG			2.5	6		1.4	0.15	06.600.4227.0	1000
1.50	norm.	16 AWG			2.8	7		1.7	0.15	06.600.4327.0	1000
2.50	norm.	14 AWG			3.4	7		2.2	0.15	06.600.4427.0	1000
4.00	norm.	12 AWG			4.0	9		2.8	0.20	06.600.4527.0	1000
6.00	norm.	10 AWG			4.7	10		3.5	0.20	06.600.4627.0	500
10.00	norm.	8 AWG			5.8	12		4.5	0.20	06.600.4727.0	500
16.00	norm.	6 AWG			7.5	12		5.8	0.20	06.600.4827.0	100
25.00	norm.	4 AWG			9.5	15		7.3	0.20	06.600.4927.0	100
35.00	norm.	2 AWG			11.0	18		8.3	0.20	06.600.5027.0	100

WIRE STRIPPERS

Description	Type	Part No.	Std. Pack
Wire strippers	AIW/A	95.350.0100.0	1
GENERAL DATA			
Wire strip length	0.08 - 10 mm ²		
Cross section, AWG	28 - 7		



CRIMPING TOOL

• for ferrules

Description	Type	Part No.	Std. Pack
Pressing tool A	Length: 180 mm PW/A	95.101.1300.0	1
Pressing tool B	Length: 203 mm PW/B	95.101.1100.0	1
Pressing tool C	Length: 203 mm PW/C	95.101.1200.0	1
GENERAL DATA			
A: Wire strip length	0.08 - 10 mm ²		
A: Cross section, AWG	28 - 7		
B: Wire strip length	10 - 25 mm ²		
B: Cross section, AWG	7 - 4		
C: Wire strip length	35 - 50 mm ²		
C: Cross section, AWG	2 - 1/0		



FACTS & DATA

DIN rail terminal blocks

ELECTRICAL AND THERMAL CHARACTERISTICS OF PLASTIC MATERIALS

Key figures / characteristics	Standard		Unit		Thermoplast Polyamide PA 666
Dielectric strength	VDE 0303-T21	IEC 243/1	kV / mm	tr./lf.	55 / 45
Dielectric loss tan δ at 1 MHz	VDE 0303-T4	IEC 250		tr./lf.	0.02 / 0.3
Specific feed through resistance	VDE 0303-T30	IEC 93	$\Omega \times \text{cm}$	lf.	10^{12}
Surface resistance	VDE 0303-T30	IEC 93	Ω	lf.	10^{10}
Creepage	VDE 0303-T1	IEC 112	CTI		600
Operating temperature RTI *	UL 746 B		$^{\circ}\text{C}$ at 1.5 mm		120
Temperature index TI **	VDE 0304 T.21	IEC 216-1	$^{\circ}\text{C}$		123 / 107
Minimum operating temperature without mechanical stress			$^{\circ}\text{C}$		-40
Flammability	UL 94		Class / material thickness		V0 / 0.4
Suitability for tropical areas					good

* electrical value ** related to 50% strain resistance drop after 5,000/20,000 hours

STANDARD CROSS SECTIONS OF ROUND COPPER CONDUCTORS AWG/METRIC

Metric size ISO	Comparison between AWG/kcmil and metric sizes		
mm ²	AWG	kcmil	mm ²
0.1*	28		0.081
0.14*	26		0.128
0.2	24		0.205
-	22		0.324
0.5	20		0.519
0.75	18		0.82
1	-		-
1.5	16		1.3
2.5	14		2.1
4	12		3.3
6	10		5.3
10	8		8.4

Metric size ISO	Comparison between AWG/kcmil and metric sizes		
mm ²	AWG	kcmil	mm ²
16	6		13.3
25	4		21.2
35	2		33.6
50	(1/0) 0		53.5
70	(2/0) 00		67.4
95	(3/0) 000		85
-	(4/0) 0000		107.2
120		250	127
150		300	152
185		350	177
240		500	253
300		600	304

* not standardized

MATERIAL SELECTION SELOS AND FASIS



METAL PARTS

- Special alloys enable low feed-through resistance and provide a gas-tight contact area:
 - Current carrying bar: Copper, or brass
 - Clamping body and clamping screws: Galvanized and chromated steel
 - Clamping spring: CrNi stainless steel
 - Current carrying bar: Copper, tinned

PLASTIC MATERIALS

- Polyamide has excellent electrical, chemical and mechanical characteristics:
 - Temperature resistance: Up to 120°C
 - Creepage resistance: CTI 600
 - Flammability class: Self-extinguishing, UL94-V0

More information available under FACTS & DATA at www.wieland-electric.com/service/download

Mounting rails

MAXIMUM SHORT-TIME CURRENT CAPABILITY ASSIGNED TO MOUNTING RAILS – DIN EN 60 947-7-2

Rail profile	Material	Equivalent	Short-time-	Rated thermal current
		E-Cu cross section	current capability 1 s	of a PEN busbar
		mm ²	kA	A
DIN rail TH 15 x 5,5 according to IEC 60 715	Steel	10	1.2	–
G rail TS 32 according to IEC 60 715	Steel	35	4.2	–
	Copper ¹⁾	120	14.4	269
	Aluminium ¹⁾	70	8.4	192
DIN rail TS 35 x 27 x 7,5 according to IEC 60 715	Steel	16	1.92	–
DIN rail TS 35 x 27 x 15 according to IEC 60 715	Steel	25	3	–
DIN rail TS 35 x 24 x 15 according to IEC 60 715 (made from 2.3 mm thick material)	Steel	50	6	–
	Copper ¹⁾	150	18	309

¹⁾ Selected copper or aluminum alloys from the manufacturer of the terminal block layout were used to achieve the values in the table.

Torques

Torque according to EN 60947-1
for selos DIN rail terminal blocks

- II applies for screws that are tightened with a screwdriver
- III applies for screws that can be tightened with tools other than a screwdriver

		II	III
WT 2.5, width 5 mm	M2.5 clamping body screw	Nm	0.4
WT 4 ... , width 6 mm	M3 clamping body screw	Nm	0.5
WT 6 and WKN 6, width 8 mm	M4 clamping body screw	Nm	1.2
	M3.5 screw for cross connector	Nm	0.8
WT 10, width 10 mm	M4 clamping body screw	Nm	1.2
WT 16, width 12 mm	M5 clamping body screw	Nm	2.0
WKN 35, width 16 mm	M6 clamping body screw	Nm	2.5 3.0
	M5 screw for cross connector	Nm	2.0 2.0
WKN 70, width 24 mm	M8 clamping body screw	Nm	3.5 6.0
	M6 screw for cross connector	Nm	2.5 3.0
WKN 150, width 28 mm	M10 clamping body screw	Nm	4.0 10.0
	M8 screw for cross connector	Nm	3.5 6.0



INFORMATION ABOUT EX APPLICATIONS

DIN rail terminal blocks for installations with explosion hazard
(Ex terminals) Protection category Increased safety “e”

EX TERMINALS

Ex terminals are DIN rail terminal blocks that have been tested and certified by a European Ex test institute according to

EN IEC 60079-0 – Explosive atmospheres - Part 0: Equipment - General requirements

EN 60079-7 – Explosive atmospheres - Part 7: Equipment protection by increased safety ,e’

The protection category Increased safety “e” applies to electrical equipment that resists sparks, electric arcing or hazardous surface temperatures during operation. DIN rail terminal blocks thus fall into temperature category T6 in which electrical equipment at an ambient temperature of 40 °C and proper use does not exceed the maximum temperature (surface temperature) of 85 °C.

However, for DIN rail terminal blocks as incomplete electrical equipment, only a partial certification is issued.

This certificate is the basis for the final acceptance and certification of the complete installation before it is commissioned by an expert.

The certificate (prototype test certificate) includes a description of the DIN rail terminal blocks, in which special requirements regarding the preparation of terminal strips are put into place, for example, installing partitions and end plates when terminal blocks are connected in series. This information is also provided in our catalog that in this case serves as an instruction manual.

TEST CERTIFICATE

Certificates from notified bodies are available for feed-through terminal blocks of series WK(N).., WKF.., WKFN.., WT and ground blocks of series WK(N)..SL.., WKF..SL.., WKFN..SL.., WT..PE as well as revos Ex industrial multipole connectors. The certificates indicate the relevant rated values and include the accessories listed in the description.

The areas of application are divided into:

Group I: Electrical equipment for mine openings with firedamp hazard

Group II: Electrical equipment for hazardous areas except for mine openings with firedamp hazard (for example installations with explosion hazard for the chemical and petrochemical industry).

According to a resolution of the DEK (Deutsche Elektrotechnische Kommission) terminal blocks are also accepted as electrical equipment for Group I (firedamp protection Ex e I) for which only the increased safety protection type ‘e’ for Group II (explosion protection Ex e II) has been certified and vice versa.

Ex protected DIN rail terminal blocks are identified with distinct safety protection and an additional marking according to ATEX directive 2014/34/EU. The complete test certificate with a description is available on request or it can be downloaded from Wieland Electric Download Center.

PROTECTION CATEGORY “INTRINSIC SAFETY EX I”

The DIN rail terminal blocks can be used in Group II (Category 2) and Group 1 (Category M2) equipment, as the standard requirements are identical in this case.

It has been generally accepted that feed-through terminals in intrinsic circuits are clearly marked with the blue coloring of the insulated housing. For intrinsic circuits, feed-through terminals can be used in the standard version and if required are available with blue insulating housing.

SAFETY INFORMATION

- The information regarding cross sectional area and connection types pertains to unprepared wires without ferrules! Ferrules are not necessary for secure connection. Whenever ferrules are used, make sure that the tools specified by the manufacturer are used exclusively.
- The voltage ratings apply to the terminals in their intended application. When different products are mounted adjacent to each other, the proper isolation distances must be adhered to.
- If the ground blocks are not used in block assemblies, but are mounted to the rail as single terminal blocks, end clamps have to be used.

ATEX REGULATION

- For the use of DIN rail terminal blocks in Ex areas, the regulations of EN 60079-0 apply; whereas for increased safety Exe the regulations of EN 60079-7 must be followed. For an approximation of the laws of the EU member states, directive 2014/34/EU was created, which is generally known as ATEX 100a and which is the basis for harmonization in this field. ATEX stands for "atmosphere explosive" while 100a refers to the corresponding article of the EC contract.
- Directive ATEX 100a applies for protection against dust and gas explosions in all industrial Ex areas and in mining. The testing and certificating institutes named in directive ATEX 100a must follow accreditation procedures which are the same throughout Europe.
- In accordance with EN 60070-0/60079-7 and ATEX 100a, these certifying institutes write out EC certificates for prototype tests. These prototype test certificates for components together with the corresponding quality system certification of the supplier are required to obtain the so-called ATEX approval.
- In combination with the  mark, the markings of the Wieland terminal blocks have the following meaning:

	Identification
II	Device group
2	Category
G D	Areas
KEMA	Name of testing institute
ATEX...	Certificate, year of testing, number



MOUNTING AND OPERATING INSTRUCTIONS TERMINALS AND ACCESSORIES FOR EX E APPLICATIONS

- If feed-through blocks are mounted directly adjacent to other feed-through blocks of a different size, or directly adjacent to ground blocks, the open side of the block group of the same type must be covered by an end plate or partition.
- If adjacent DIN rail terminal blocks are jumpered or if jumpered DIN rail terminal blocks are positioned next to unjumpered DIN rail terminal blocks, a partition plate must be inserted between the individual terminal block groups or at the beginning and end of a laterally or longitudinally connected terminal block (group) in order to meet the specified isolation distances. Notched out and jumpering cross connectors can only be used for terminal types WT2.5; WT4 and WT6. It is essential to observe the product descriptions and the „Special conditions of use“ of the ATEX or IEC Ex certificate and the „EX-INFORMATION“ A2020.000.
- If the terminal blocks are combined with other certified series and sizes and when their accessories are used, the required creepage distances and clearances must be adhered to.
- The feed through terminal blocks and protective conductor terminal blocks are suitable for enclosures for use in explosive gas atmospheres or for use in the presence of combustible dust. For explosive gas atmospheres these enclosures must satisfy the requirements of EN 60079-0 and EN 60079-7. For combustible dust these enclosures must satisfy the requirements of 60079-0 and EN 60079-31.
- If the DIN rail terminal blocks are installed in a housing with protection type "e" (increased safety) according to EN 60079-7, the clearances and creepage distances stated in Table 2 must be adhered to..
- The indicated values for the current carrying capability refer to a maximum ambient temperature of 40 °C. When the terminal blocks are loaded with the maximum rated current the temperature rise will be max. 45 K.
- Operating temperature range:

-40° C - +80° C, series WK(N)/M..., WKF..., WT
-20° C - +80° C, series WKFN
- If cables are used whose cross-section is smaller than the nominal cable cross-section, the corresponding lower current must be specified in the EC prototype test certificate for the complete device.
- Due to the heat generated during operation at the specified current and at ambient temperatures of ≤ 40 °C, the DIN rail terminal blocks can be installed in equipment (mainly distribution and connection boxes) suitable for temperature class T6. If DIN rail terminal blocks are installed in equipment with a temperature class ranging from T1 to T5, it must be ensured that the maximum temperature of the insulating parts does not exceed the maximum value in the operating temperature range.
- When using Ex terminals, the product descriptions, installation instructions and the „Special conditions of use“ of the Ex certificates (EU type examination certificate) must be observed.

TEMPERATURE CLASSES

Temperature class	T1	T2	T3	T4	T5	T6
Maximum surface temperature at equipment in °C	450	300	200	135	120	85

CUSTOMIZED ASSEMBLY



TERMINAL BLOCK ASSEMBLIES

For those who want to make their control cabinet work easier Wieland Electric pre-assembles completely equipped DIN rail terminal block assemblies, even with the cables connected, if required.



CABLE ASSEMBLIES

Individual cables tailored to your needs and combined with various components can be delivered for your project in all lengths.



CONTROL AND DISTRIBUTION PANELS

Our value-add departments will gladly assist you in selecting individual Wieland components, or in laying out complete panels, which we can also build for you.



INTERFACE MODULES – SOLUTION SPECIFIC CONNECTIVITY

Each control cabinet requires distribution functionality. In most cases this is accomplished with standard control panel wiring (0.5 mm or 1.5 mm fine stranded with ferrule) to standardized interfaces (d-sub or ribbon cables). Upon the customer's request Wieland Electric can design individual and customized solutions for all applications, too.

INDEX

PART NUMBER | PAGE

01.108.7653.0	139	04.342.3556.8	34	04.343.9253.8	155	04.420.0581.2	146
01.299.9753.0	155	04.343.4756.8	22	04.344.1455.8	15	04.420.0681.2	146
04.019.0289.0	138	04.343.4956.8	42	04.344.1655.8	15	04.420.0781.0	147
04.019.0289.0	138	04.343.5056.8	42	04.344.1855.8	15	04.420.0781.2	147
04.019.0289.0	139	04.343.5256.8	16	04.344.1855.8	15	04.420.0781.8	147
04.019.0289.0	139	04.343.5256.8	155	04.344.2255.8	15	04.420.1081.0	147
04.019.0289.0	153	04.343.5356.8	16	04.344.2655.0	118	04.420.1081.2	147
04.019.1189.0	138	04.343.5356.8	155	04.344.2655.0	119	04.420.1081.8	147
04.019.1189.0	139	04.343.5456.8	16	04.344.2655.0	120	04.420.1281.0	147
04.241.1150.0	152	04.343.5456.8	155	04.344.2655.0	120	04.420.1281.2	147
04.242.0850.0	150	04.343.6053.8	98	04.344.2655.0	120	04.420.1381.0	147
04.242.0950.0	153	04.343.6053.8	98	04.400.0081.2	143	04.420.1481.2	147
04.242.1250.0	153	04.343.6153.8	67	04.400.0281.2	143	04.420.1581.2	146
04.242.1553.0	150	04.343.6153.8	74	04.400.0281.2	149	04.420.1581.8	146
04.242.2853.0	153	04.343.6153.8	90	04.403.0056.0	143	04.420.1681.2	146
04.242.5053.0	150	04.343.6153.8	91	04.405.0056.0	143	04.420.1681.8	146
04.242.5153.0	150	04.343.6153.8	93	04.405.1056.0	143	04.420.1781.2	146
04.242.6053.0	151	04.343.6153.8	155	04.405.1156.0	143	04.420.1781.8	146
04.242.6353.0	151	04.343.6253.8	68	04.405.1256.0	143	04.420.1881.2	146
04.242.8053.0	151	04.343.6253.8	75	04.406.0056.0	143	04.543.0056.0	150
04.243.0755.0	81	04.343.6253.8	155	04.406.0156.0	143	04.543.0156.0	150
04.243.0855.0	83	04.343.6453.8	69	04.408.0056.0	143	04.543.0256.0	150
04.243.0855.0	85	04.343.6453.8	77	04.410.0181.0	144	04.543.0356.0	150
04.243.0855.0	124	04.343.6453.8	155	04.410.0281.0	144	04.543.0456.0	150
04.243.0855.0	124	04.343.6653.8	65	04.410.0381.0	144	04.543.0556.0	150
04.243.0953.0	78	04.343.6653.8	67	04.410.0481.0	144	04.543.0656.0	150
04.243.0953.0	78	04.343.6653.8	70	04.410.0581.0	144	04.543.0756.0	150
04.243.0953.0	78	04.343.6653.8	70	04.410.0681.0	144	04.543.0856.0	150
04.243.2053.0	150	04.343.6653.8	77	04.410.0781.0	144	04.543.0956.0	150
04.243.8550.0	138	04.343.6653.8	93	04.410.0881.0	144	04.543.1056.0	150
04.243.8550.0	139	04.343.6653.8	155	04.410.0981.0	144	04.553.0056.0	150
04.244.0053.0	104	04.343.6853.8	99	04.410.1081.2	144	04.553.0156.0	150
04.244.0053.0	105	04.343.6953.8	155	04.410.1081.8	144	04.553.0256.0	150
04.244.0053.0	107	04.343.8353.8	65	04.410.1281.2	144	04.553.0356.0	150
04.312.2056.0	33	04.343.8353.8	73	04.410.1481.8	145	04.553.0456.0	150
04.326.2053.8	22	04.343.8353.8	81	04.410.1581.0	145	04.553.0556.0	150
04.326.2053.8	27	04.343.8353.8	83	04.410.1681.2	145	04.553.0656.0	150
04.326.2053.8	35	04.343.8353.8	85	04.410.1781.0	145	04.553.0756.0	150
04.326.2153.8	37	04.343.8353.8	89	04.410.1881.2	145	04.553.0856.0	150
04.326.2253.8	42	04.343.8353.8	97	04.410.1981.0	145	04.553.0956.0	150
04.326.2353.8	42	04.343.8353.8	98	04.410.2081.2	145	04.553.1056.0	150
04.326.2553.8	16	04.343.8353.8	99	04.410.2081.8	145	04.553.3156.0	150
04.326.2653.8	16	04.343.8353.8	155	04.420.0181.2	146	04.553.3256.0	150
04.326.2953.8	50	04.343.9056.8	35	04.420.0181.8	146	04.841.1150.0	152
04.326.3053.8	50	04.343.9156.8	35	04.420.0381.2	146	04.841.1250.0	152
04.342.0556.0	27	04.343.9253.8	77	04.420.0481.2	146	04.841.1350.0	152



INDEX

PART NUMBER | PAGE

04.841.1450.0	152	04.842.6053.0	151	04.855.0053.0	150	04.858.3253.0	151
04.841.1550.0	152	04.842.6553.0	151	04.855.0153.0	150	04.900.0000.0	153
04.841.1650.0	152	04.842.7953.0	151	04.855.0253.0	150	04.900.1053.0	153
04.841.1750.0	152	04.842.8053.0	151	04.855.0253.5	27	04.900.2053.0	153
04.841.1850.0	152	04.842.8553.0	151	04.855.0353.0	150	04.900.3053.0	153
04.841.1950.0	152	04.842.8553.0	151	04.855.0353.6	27	04.900.4053.0	153
04.841.2050.0	152	04.843.2053.0	150	04.855.0453.0	150	05.502.4000.0	156
04.841.2150.0	152	04.844.2053.0	104	04.855.0553.0	150	05.502.4000.0	156
04.841.2250.0	152	04.844.2053.0	105	04.855.0653.0	150	05.502.4100.0	156
04.841.2350.0	152	04.844.2053.0	107	04.855.0753.0	150	05.502.4100.0	156
04.841.2450.0	152	04.844.2153.0	104	04.855.0853.0	150	05.511.2953.0	41
04.841.2550.0	152	04.844.2153.0	105	04.855.0953.0	150	05.511.2953.6	41
04.841.2650.0	152	04.844.2153.0	107	04.855.1053.0	150	05.511.2953.7	41
04.841.2750.0	152	04.844.2253.0	104	04.855.1153.0	153	05.511.2953.8	41
04.841.2850.0	152	04.844.2253.0	105	04.855.1253.0	153	05.511.2953.9	41
04.841.2950.0	152	04.844.2253.0	107	04.855.3153.0	150	05.561.0053.0	34
04.841.3050.0	152	04.845.0153.0	150	04.855.3253.0	150	05.561.0053.0	34
04.841.3150.0	152	04.845.0253.0	150	04.856.0053.0	151	05.561.0053.0	99
04.841.3250.0	152	04.845.0353.0	150	04.856.0153.0	151	05.561.4125.0	35
04.841.3350.0	152	04.845.0453.0	150	04.856.0253.0	151	05.561.6553.0	98
04.841.3450.0	152	04.845.0553.0	150	04.856.0353.0	151	05.561.6553.0	98
04.841.3550.0	152	04.845.0653.0	150	04.856.0453.0	151	05.561.6553.0	104
04.841.3650.0	152	04.845.0753.0	150	04.856.0553.0	151	05.561.6553.0	105
04.841.3750.0	152	04.845.0853.0	150	04.856.0653.0	151	05.561.6553.0	107
04.841.3850.0	152	04.845.0953.0	150	04.856.0753.0	151	05.561.6653.0	98
04.841.3950.0	152	04.845.1053.0	150	04.856.0853.0	151	05.561.6653.0	98
04.841.4050.0	152	04.846.0153.0	151	04.856.0953.0	151	05.561.6653.0	104
04.841.4150.0	152	04.846.0253.0	151	04.856.1053.0	151	05.561.6653.0	105
04.841.4250.0	152	04.846.0353.0	151	04.856.1153.0	153	05.561.6653.0	107
04.841.4350.0	152	04.846.0453.0	151	04.856.1253.0	153	05.561.6753.0	98
04.841.4450.0	152	04.846.0553.0	151	04.856.3153.0	151	05.561.6753.0	98
04.841.4550.0	152	04.846.0653.0	151	04.856.3253.0	151	05.561.6753.0	104
04.841.4650.0	152	04.846.0753.0	151	04.858.0053.0	151	05.561.6753.0	105
04.841.4750.0	152	04.846.0853.0	151	04.858.0153.0	151	05.561.6753.0	107
04.841.7450.0	152	04.846.0953.0	151	04.858.0253.0	151	05.561.8553.0	67
04.841.7550.0	152	04.846.1053.0	151	04.858.0353.0	151	05.561.8553.0	74
04.841.7650.0	152	04.848.0153.0	151	04.858.0453.0	151	05.561.8553.0	87
04.841.7750.0	152	04.848.0253.0	151	04.858.0553.0	151	05.561.8553.0	90
04.841.9050.0	152	04.848.0353.0	151	04.858.0653.0	151	05.561.8553.0	91
04.841.9150.0	152	04.848.0453.0	151	04.858.0753.0	151	05.561.8553.0	93
04.842.0850.0	150	04.848.0553.0	151	04.858.0853.0	151	05.561.8553.0	156
04.842.1553.0	150	04.848.0653.0	151	04.858.0953.0	151	05.561.8653.0	67
04.842.4953.0	150	04.848.0753.0	151	04.858.1053.0	151	05.561.8653.0	74
04.842.5053.0	150	04.848.0853.0	151	04.858.1153.0	153	05.561.8653.0	87
04.842.5553.0	151	04.848.0953.0	151	04.858.1253.0	153	05.561.8653.0	90
04.842.5953.0	151	04.848.1053.0	151	04.858.3153.0	151	05.561.8653.0	91

INDEX

PART NUMBER | PAGE

05.561.8653.0	93	05.564.3855.0	123	06.502.4100.0	127	06.600.3327.0	157
05.561.8653.0	156	05.564.3855.0	125	06.502.4100.0	156	06.600.3427.0	157
05.561.8753.0	67	05.564.3855.0	156	06.502.4200.0	65	06.600.3527.0	157
05.561.8753.0	74	05.564.3955.0	65	06.502.4200.0	67	06.600.4027.0	157
05.561.8753.0	87	05.564.3955.0	73	06.502.4200.0	69	06.600.4127.0	157
05.561.8753.0	90	05.564.3955.0	81	06.502.4200.0	71	06.600.4227.0	157
05.561.8753.0	91	05.564.3955.0	83	06.502.4200.0	77	06.600.4327.0	157
05.561.8753.0	93	05.564.3955.0	85	06.502.4200.0	93	06.600.4427.0	157
05.561.8753.0	156	05.564.3955.0	89	06.502.4200.0	156	06.600.4527.0	157
05.561.9153.0	35	05.564.3955.0	97	06.502.4200.0	156	06.600.4627.0	157
05.562.2453.0	98	05.564.3955.0	123	06.502.4200.0	156	06.600.4727.0	157
05.562.2453.0	99	05.564.3955.0	125	06.502.4300.0	63	06.600.4827.0	157
05.562.2453.0	100	05.564.3955.0	156	06.502.4300.0	72	06.600.4927.0	157
05.562.2453.0	100	05.566.6855.9	39	06.502.4300.0	118	06.600.5027.0	157
05.562.2453.0	101	05.567.9155.0	97	06.502.4300.0	119	07.201.1227.6	46
05.562.2453.0	101	05.576.5853.0	34	06.502.4300.0	121	07.201.1327.6	46
05.562.2553.0	98	05.584.0053.0	34	06.502.4300.0	156	07.201.3227.6	46
05.562.2553.0	99	05.902.3500.0	104	06.502.5000.0	65	07.201.3327.6	46
05.562.2553.0	100	05.902.3500.0	105	06.502.5000.0	67	07.201.4227.0	48
05.562.2553.0	100	05.902.3500.0	107	06.502.5000.0	73	07.201.4227.0	49
05.562.2553.0	101	06.502.4000.0	65	06.502.5000.0	74	07.201.4327.0	48
05.562.2553.0	101	06.502.4000.0	67	06.502.5000.0	83	07.201.4327.0	49
05.562.2653.0	98	06.502.4000.0	73	06.502.5000.0	89	07.201.4427.0	48
05.562.2653.0	99	06.502.4000.0	74	06.502.5000.0	90	07.201.4427.0	49
05.562.2653.0	100	06.502.4000.0	83	06.502.5000.0	91	07.201.5227.6	46
05.562.2653.0	100	06.502.4000.0	89	06.502.5000.0	93	07.201.5327.6	46
05.562.2653.0	101	06.502.4000.0	90	06.502.5000.0	97	07.201.7227.6	47
05.562.2653.0	101	06.502.4000.0	91	06.502.5000.0	97	07.201.7327.6	47
05.563.5453.0	41	06.502.4000.0	93	06.502.5000.0	103	07.201.8227.0	49
05.564.3755.0	65	06.502.4000.0	97	06.502.5000.0	123	07.201.8327.0	49
05.564.3755.0	73	06.502.4000.0	97	06.502.5000.0	125	07.201.8427.0	49
05.564.3755.0	81	06.502.4000.0	99	06.502.5000.0	156	07.201.9227.6	47
05.564.3755.0	83	06.502.4000.0	100	06.502.5000.0	156	07.201.9327.6	47
05.564.3755.0	85	06.502.4000.0	100	06.600.2027.0	157	07.205.1227.0	48
05.564.3755.0	89	06.502.4000.0	101	06.600.2127.0	157	07.205.1327.0	48
05.564.3755.0	97	06.502.4000.0	101	06.600.2227.0	157	07.205.1427.0	48
05.564.3755.0	123	06.502.4000.0	103	06.600.2327.0	157	07.205.5227.0	47
05.564.3755.0	125	06.502.4000.0	104	06.600.2427.0	157	07.205.5327.0	47
05.564.3755.0	156	06.502.4000.0	105	06.600.2527.0	157	07.205.7227.0	47
05.564.3855.0	65	06.502.4000.0	107	06.600.2627.0	157	07.205.7327.0	47
05.564.3855.0	73	06.502.4000.0	123	06.600.2727.0	157	07.205.8227.0	47
05.564.3855.0	81	06.502.4000.0	125	06.600.2827.0	157	07.205.8327.0	47
05.564.3855.0	83	06.502.4000.0	156	06.600.2927.0	157	07.205.9227.0	47
05.564.3855.0	85	06.502.4000.0	156	06.600.3027.0	157	07.205.9327.0	47
05.564.3855.0	89	06.502.4100.0	68	06.600.3127.0	157	07.257.0227.0	27
05.564.3855.0	97	06.502.4100.0	75	06.600.3227.0	157	07.257.0327.0	27



INDEX

PART NUMBER | PAGE

07.257.2027.0	27	07.311.9055.0	34	07.312.6755.0	122	07.312.8053.0	113
07.300.6955.0	43	07.311.9155.0	34	07.312.6755.0	123	07.312.8153.0	62
07.300.7055.0	43	07.311.9455.0	55	07.312.6755.6	64	07.312.8153.0	72
07.310.5855.0	36	07.311.9455.0	55	07.312.6855.0	64	07.312.8353.0	62
07.310.9355.0	27	07.311.9855.0	34	07.312.6855.0	122	07.312.8353.0	72
07.310.9455.0	27	07.312.0453.0	39	07.312.6855.0	123	07.312.8553.0	62
07.311.0753.0	50	07.312.0453.0	41	07.312.6955.0	64	07.312.8553.0	72
07.311.0853.0	50	07.312.0453.0	42	07.312.6955.0	73	07.312.8753.0	78
07.311.0853.0	50	07.312.0453.0	42	07.312.6955.0	88	07.312.8753.0	78
07.311.0853.6	50	07.312.0453.0	43	07.312.6955.0	96	07.312.8753.0	78
07.311.0853.6	50	07.312.0453.0	43	07.312.6955.0	122	07.312.9055.0	66
07.311.1853.0	50	07.312.0555.0	26	07.312.6955.0	123	07.312.9055.0	74
07.311.1853.0	50	07.312.0555.0	26	07.312.6955.6	64	07.312.9055.0	90
07.311.2053.8	22	07.312.1255.0	25	07.312.6955.6	96	07.312.9055.0	90
07.311.2053.8	27	07.312.1255.0	25	07.312.7055.0	64	07.312.9055.0	91
07.311.2053.8	35	07.312.1555.0	34	07.312.7055.0	88	07.312.9055.0	92
07.311.2153.8	37	07.312.1655.0	34	07.312.7055.0	96	07.312.9055.0	92
07.311.2853.8	50	07.312.1755.0	22	07.312.7055.0	122	07.312.9055.6	66
07.311.2953.8	50	07.312.1855.0	22	07.312.7055.0	123	07.312.9155.0	66
07.311.3855.0	37	07.312.1955.0	54	07.312.7155.0	64	07.312.9155.0	90
07.311.4155.0	33	07.312.1955.0	54	07.312.7155.0	73	07.312.9155.0	90
07.311.4255.0	36	07.312.2153.0	110	07.312.7155.0	88	07.312.9155.0	91
07.311.4355.0	36	07.312.2153.0	110	07.312.7155.0	122	07.312.9155.0	92
07.311.4655.0	37	07.312.2253.0	110	07.312.7155.0	123	07.312.9155.0	92
07.311.6155.0	29	07.312.2253.0	110	07.312.7155.6	64	07.312.9255.0	66
07.311.6155.0	30	07.312.2953.0	105	07.312.7255.0	64	07.312.9255.0	74
07.311.6155.0	30	07.312.2953.0	107	07.312.7255.0	88	07.312.9255.6	66
07.311.6155.0	30	07.312.2953.6	105	07.312.7255.0	122	07.312.9355.0	66
07.311.6555.0	56	07.312.2953.6	107	07.312.7255.0	123	07.312.9455.0	66
07.311.6555.0	56	07.312.2953.9	105	07.312.7355.0	81	07.312.9455.0	74
07.311.6555.0	56	07.312.2953.9	107	07.312.7355.0	96	07.312.9455.6	66
07.311.6855.0	57	07.312.3153.0	104	07.312.7355.0	124	07.312.9555.0	66
07.311.6855.0	57	07.312.3153.6	104	07.312.7355.0	124	07.312.9655.0	87
07.311.6955.0	56	07.312.3153.9	104	07.312.7355.0	124	07.312.9755.0	87
07.311.6955.0	56	07.312.3553.0	99	07.312.7455.0	81	07.313.0055.0	88
07.311.7855.0	16	07.312.3653.0	99	07.312.7455.0	96	07.313.0055.0	96
07.311.7955.0	16	07.312.4153.0	98	07.312.7455.0	124	07.313.0155.0	88
07.311.8155.0	29	07.312.4153.0	98	07.312.7455.0	124	07.313.0155.0	96
07.311.8155.0	30	07.312.4153.6	98	07.312.7555.0	85	07.313.0253.0	128
07.311.8155.0	30	07.312.4753.0	98	07.312.7655.0	85	07.313.0253.0	128
07.311.8155.0	30	07.312.5653.0	109	07.312.7755.0	83	07.313.0253.0	128
07.311.8353.0	112	07.312.5953.0	103	07.312.7755.0	89	07.313.0253.0	129
07.311.8353.0	112	07.312.6053.0	15	07.312.7755.0	89	07.313.0353.0	129
07.311.8353.0	112	07.312.6053.0	155	07.312.7855.0	83	07.313.0455.0	68
07.311.8353.0	113	07.312.6755.0	64	07.312.7855.0	89	07.313.0455.0	75
07.311.8855.0	55	07.312.6755.0	73	07.312.7855.0	89	07.313.0455.6	68

INDEX

PART NUMBER | PAGE

07.313.0555.0	68	07.313.2955.0	20	07.340.0353.0	48	25.920.3853.0	99
07.313.0655.0	68	07.313.2955.0	21	07.340.1053.0	48	25.920.3953.0	99
07.313.0655.0	75	07.313.2955.0	21	07.340.1053.0	49	25.920.4053.0	99
07.313.0655.6	68	07.313.2955.0	21	07.340.1053.0	49	25.920.4153.0	99
07.313.0755.0	68	07.313.3155.0	20	07.340.3553.0	47	25.920.4253.0	99
07.313.0855.0	69	07.313.3355.0	23	07.340.3653.0	47	25.920.4353.0	99
07.313.0855.0	76	07.313.3355.0	23	07.340.3753.0	47	25.920.4453.0	99
07.313.0855.6	69	07.313.3355.0	23	07.340.3753.0	47	25.920.4553.0	99
07.313.0955.0	69	07.313.3355.0	24	07.431.7053.8	46	25.920.4653.0	99
07.313.1055.0	69	07.313.4155.0	126	07.431.7153.8	46	30.494.3021.6	54
07.313.1055.0	76	07.313.4155.0	127	07.431.7253.8	46	30.494.3021.6	54
07.313.1055.6	69	07.313.4255.0	126	07.431.7353.8	47	30.494.3021.6	54
07.313.1155.0	69	07.313.4255.0	127	07.431.7353.8	47	30.494.3021.6	109
07.313.1255.0	70	07.313.4355.0	54	25.320.0253.0	35	30.494.3021.6	109
07.313.1255.0	76	07.313.4455.0	118	25.320.1653.0	35	30.494.3021.6	109
07.313.1255.6	70	07.313.4455.0	119	25.320.3253.0	35	30.494.4021.1	135
07.313.1355.0	70	07.313.4555.0	118	25.320.4653.0	35	30.494.4021.6	54
07.313.1455.0	70	07.313.4555.0	119	25.325.0253.0	35	30.494.4021.6	54
07.313.1455.0	77	07.313.4655.0	118	25.325.1653.0	35	30.494.4021.6	54
07.313.1455.6	70	07.313.4655.0	119	25.325.3253.0	35	30.494.4021.6	109
07.313.1555.0	70	07.313.4755.0	120	25.325.4653.0	35	30.494.4021.6	109
07.313.1655.0	90	07.313.4755.0	120	25.360.0253.0	35	30.494.4021.6	109
07.313.1655.0	92	07.313.4755.0	120	25.360.1253.0	35	30.494.4121.0	54
07.313.1655.0	92	07.313.4855.0	121	25.360.3253.0	35	30.494.4121.0	54
07.313.1755.0	39	07.313.4855.0	121	25.360.4253.0	35	30.494.4121.0	54
07.313.2355.0	42	07.313.4855.0	121	25.920.0253.0	99	30.494.4121.0	109
07.313.2455.0	42	07.313.4955.0	118	25.920.0353.0	99	30.494.4121.0	109
07.313.2555.0	14	07.313.4955.0	119	25.920.0453.0	99	30.494.4121.0	109
07.313.2555.0	14	07.313.5155.0	80	25.920.0553.0	99	30.494.4121.0	135
07.313.2555.0	14	07.313.5155.0	80	25.920.0653.0	99	32.530.0053.0	47
07.313.2555.0	15	07.313.5155.0	80	25.920.0753.0	99	32.540.0053.0	47
07.313.2555.0	18	07.313.5255.0	126	25.920.0853.0	99	32.550.0053.0	47
07.313.2555.0	18	07.313.5255.0	126	25.920.0953.0	99	32.560.0053.0	47
07.313.2555.0	18	07.313.5255.0	127	25.920.1053.0	99	37.702.7453.0	100
07.313.2555.0	19	07.313.5255.0	127	25.920.1153.0	99	37.702.7553.0	100
07.313.2655.0	15	07.313.5355.0	126	25.920.1253.0	99	37.702.7653.0	101
07.313.2755.0	15	07.313.5355.0	127	25.920.1353.0	99	37.702.8453.0	100
07.313.2755.0	19	07.313.5455.0	126	25.920.1453.0	99	37.702.8553.0	100
07.313.2855.0	15	07.313.5455.0	127	25.920.1553.0	99	37.702.8653.0	101
07.313.2855.0	20	07.313.5555.0	118	25.920.1653.0	99	37.703.0553.0	104
07.313.2855.0	20	07.313.5555.0	118	25.920.3253.0	99	37.703.0553.6	104
07.313.2855.0	21	07.313.5555.0	119	25.920.3353.0	99	37.703.0553.9	104
07.313.2855.0	21	07.313.5555.0	119	25.920.3453.0	99	37.703.1053.0	104
07.313.2855.0	21	07.313.5555.0	120	25.920.3553.0	99	37.703.1053.6	104
07.313.2855.0	23	07.313.5555.0	120	25.920.3653.0	99	37.703.1053.9	104
07.313.2855.0	23	07.313.5555.0	120	25.920.3753.0	99	38.703.0553.0	105



INDEX

PART NUMBER | PAGE

38.703.0553.6	105	56.202.8055.0	121	56.397.1255.0	48	56.703.0553.7	107
38.703.0553.9	105	56.202.8155.0	121	56.398.0055.0	49	56.703.0553.9	107
38.703.1053.0	105	56.202.8255.0	121	56.398.1055.0	49	56.703.1053.0	107
38.703.1053.6	105	56.202.9055.0	119	56.399.0055.0	49	56.703.1053.6	107
38.703.1053.9	105	56.202.9155.0	119	56.399.0155.0	49	56.703.1053.7	107
39.703.0153.0	104	56.202.9255.0	120	56.399.0255.0	49	56.703.1053.9	107
39.703.0153.6	104	56.202.9355.0	119	56.399.1055.0	49	56.703.2053.0	98
39.703.0153.9	104	56.202.9555.0	121	56.399.1255.0	49	56.703.2053.6	98
39.703.0253.0	104	56.202.9655.0	121	56.404.8855.0	57	56.703.2155.0	96
39.703.0253.6	104	56.203.0055.0	122	56.404.9155.0	57	56.703.2155.6	96
39.703.0253.9	104	56.203.0055.6	122	56.404.9255.0	56	56.703.2255.0	96
55.503.1053.0	50	56.203.5055.0	122	56.404.9455.0	56	56.703.2355.0	96
55.503.1053.6	50	56.203.5055.6	122	56.404.9555.0	56	56.703.2355.6	96
55.504.1053.0	50	56.203.5155.0	122	56.404.9655.0	56	56.703.2455.0	96
55.504.1053.6	50	56.203.5155.6	122	56.404.9755.0	56	56.703.2955.1	84
55.504.9153.0	50	56.203.6955.1	124	56.404.9855.0	56	56.703.3055.0	84
55.703.0053.0	103	56.203.7055.0	124	56.503.7355.0	26	56.703.3255.0	85
55.703.0053.6	103	56.203.8553.0	129	56.503.7455.0	26	56.703.3355.0	85
55.703.0553.0	106	56.203.8653.0	129	56.503.7555.0	26	56.703.3455.0	96
55.703.0553.6	106	56.203.8953.0	128	56.503.7655.0	26	56.703.3555.1	96
55.703.0553.7	106	56.203.8955.0	124	56.503.8355.0	25	56.703.3655.0	96
55.703.0553.9	106	56.203.9055.0	123	56.503.8455.0	25	56.703.4755.0	80
55.703.1053.0	106	56.203.9155.0	123	56.503.8555.0	25	56.703.4855.1	80
55.703.1053.6	106	56.203.9355.0	123	56.510.9255.0	55	56.703.4955.0	80
55.703.1053.7	106	56.203.9453.0	128	56.516.9255.0	55	56.703.5055.0	64
55.703.1053.9	106	56.203.9553.0	129	56.535.9255.0	55	56.703.5055.6	64
55.703.9053.0	103	56.203.9653.0	128	56.702.0053.0	62	56.703.5155.0	64
56.106.0055.0	39	56.203.9753.0	128	56.702.0053.6	62	56.703.5155.6	64
56.106.0155.0	39	56.203.9853.0	128	56.702.2053.0	98	56.703.5355.0	88
56.106.0553.0	41	56.206.0055.0	126	56.702.5053.0	62	56.703.5455.0	88
56.106.0653.0	41	56.206.0055.6	126	56.702.5053.6	62	56.703.5555.0	88
56.106.0755.0	39	56.206.5055.0	126	56.702.5153.0	62	56.703.5955.1	82
56.106.0855.0	39	56.206.5055.6	126	56.702.5153.6	62	56.703.6055.0	82
56.135.1055.0	46	56.206.5155.0	126	56.702.6953.1	78	56.703.6155.0	83
56.170.1055.0	46	56.206.5155.6	126	56.702.7053.0	99	56.703.6255.0	82
56.197.1055.0	46	56.206.9055.0	127	56.702.7653.0	78	56.703.6355.0	82
56.198.1055.0	47	56.206.9155.0	127	56.702.9053.0	72	56.703.6455.0	83
56.199.1055.0	47	56.206.9355.0	127	56.702.9153.0	72	56.703.6555.0	89
56.202.0055.0	118	56.395.0055.0	48	56.702.9253.0	78	56.703.6655.0	89
56.202.0055.6	118	56.395.0155.0	48	56.702.9353.0	72	56.703.6955.1	79
56.202.5055.0	118	56.395.0255.0	48	56.703.0053.0	110	56.703.7055.0	79
56.202.5055.6	118	56.395.1055.0	48	56.703.0053.6	110	56.703.7155.5	81
56.202.5155.0	118	56.395.1255.0	48	56.703.0055.0	64	56.703.7155.9	81
56.202.5155.6	118	56.397.0055.0	48	56.703.0055.6	64	56.703.7355.5	81
56.202.6955.1	120	56.397.0155.0	48	56.703.0553.0	107	56.703.7555.5	81
56.202.7055.0	120	56.397.0255.0	48	56.703.0553.6	107	56.703.7555.9	81

INDEX

PART NUMBER | PAGE

56.703.7655.0	79	56.704.9255.0	86	57.106.1055.0	43	57.516.1155.6	55
56.703.7755.0	81	56.704.9355.0	74	57.106.1155.0	43	57.516.8255.0	54
56.703.7855.0	81	56.706.0053.0	110	57.110.1555.0	31	57.535.0155.0	16
56.703.7955.5	81	56.706.0053.6	110	57.110.1655.0	31	57.535.0155.6	16
56.703.8155.9	81	56.706.0055.0	68	57.403.6955.1	22	57.535.1155.0	55
56.703.8255.5	81	56.706.0055.6	68	57.403.7055.0	22	57.535.1155.6	55
56.703.8355.5	81	56.706.5055.0	68	57.503.2055.0	34	57.535.9055.0	17
56.703.8653.0	113	56.706.5055.6	68	57.503.2155.0	34	57.570.0155.0	16
56.703.8855.0	84	56.706.9053.0	110	57.503.2255.0	34	57.570.0155.6	16
56.703.8955.0	79	56.706.9055.0	75	57.503.2355.0	34	57.570.9055.0	17
56.703.9053.0	110	56.706.9355.0	75	57.503.2555.6	34	57.597.0155.0	16
56.703.9055.0	73	56.710.0053.0	111	57.503.2655.0	34	57.597.0155.6	16
56.703.9155.0	73	56.710.0053.6	111	57.503.2755.0	34	57.904.2055.0	31
56.703.9253.0	98	56.710.0055.0	69	57.503.2855.0	34	57.904.2555.0	31
56.703.9355.0	73	56.710.0055.0	71	57.503.3055.6	34	57.904.2855.0	31
56.703.9453.0	112	56.710.0055.6	69	57.503.7055.0	27	57.904.5355.0	32
56.703.9553.0	113	56.710.0055.6	71	57.503.7155.0	27	57.904.5455.0	32
56.703.9653.0	112	56.710.5055.0	69	57.503.7255.0	27	57.904.5555.0	32
56.703.9753.0	112	56.710.5055.0	71	57.503.7855.0	26	57.904.5655.0	32
56.703.9853.0	112	56.710.5055.6	69	57.503.7955.0	26	57.904.5755.0	32
56.703.9953.0	112	56.710.5055.6	71	57.503.8055.0	26	57.904.5855.0	32
56.703.XX55.5	81	56.710.8153.0	109	57.503.8855.0	25	57.904.6355.0	32
56.703.XX55.9	81	56.710.9053.0	111	57.503.8955.0	25	57.904.6455.0	32
56.704.0053.0	110	56.710.9055.0	76	57.503.9055.0	25	57.904.6555.0	32
56.704.0053.6	110	56.710.9355.0	76	57.504.1655.0	30	57.904.6655.0	32
56.704.0055.0	66	56.716.0053.0	111	57.504.1755.0	30	57.904.6755.0	32
56.704.0055.6	66	56.716.0053.6	111	57.504.2055.0	30	57.904.6855.0	32
56.704.4055.0	90	56.716.0055.0	70	57.504.2055.6	30	57.910.5055.0	33
56.704.4055.0	90	56.716.0055.6	70	57.504.2355.0	30	57.910.5155.0	33
56.704.4055.0	91	56.716.0353.0	65	57.504.3655.0	37	57.910.5255.0	33
56.704.4055.0	91	56.716.0353.0	67	57.504.3755.0	37	57.910.5355.0	33
56.704.4155.0	92	56.716.0353.0	93	57.504.4055.0	28	57.910.5455.0	33
56.704.4255.0	92	56.716.1155.0	111	57.504.4055.0	28	57.910.5755.0	33
56.704.5055.0	66	56.716.1155.6	111	57.504.4055.0	29	57.910.5855.0	33
56.704.5055.6	66	56.716.5055.0	70	57.504.4055.0	29	57.910.6155.0	33
56.704.5155.0	66	56.716.5055.6	70	57.504.4555.0	30	58.503.0055.0	14
56.704.5155.6	66	56.716.8155.0	109	57.504.4855.0	30	58.503.0055.6	14
56.704.5355.0	92	56.716.9053.0	111	57.504.6255.0	36	58.503.2055.0	21
56.704.6955.1	86	56.716.9055.0	76	57.504.6355.0	36	58.503.2055.6	21
56.704.7055.0	86	56.716.9155.0	111	57.504.7355.0	36	58.503.2155.0	21
56.704.7655.0	86	56.716.9355.0	77	57.506.0555.0	42	58.503.2155.6	21
56.704.8153.0	109	56.735.0053.0	70	57.510.0555.0	42	58.503.2355.0	21
56.704.8453.0	85	56.735.0053.0	71	57.510.1155.0	55	58.503.9055.0	18
56.704.9053.0	110	56.735.0053.6	70	57.510.1155.6	55	58.504.0055.0	14
56.704.9055.0	74	56.735.0053.6	71	57.510.8255.0	54	58.504.0055.6	14
56.704.9155.0	74	56.735.9053.0	77	57.516.1155.0	55	58.504.2055.0	21



INDEX

PART NUMBER | PAGE

58.504.2055.6	21	95.502.0100.0	149	98.290.0000.0	54	Z1.298.1053.0	28
58.504.2355.0	21	95.502.0118.0	149	98.290.0000.0	56	Z1.298.1053.0	90
58.504.4155.0	21	95.502.0125.0	149	98.290.1000.0	54	Z1.298.1153.0	28
58.504.5055.0	20	95.502.0125.1	149	98.290.1000.0	54	Z1.298.1153.0	90
58.504.5055.6	20	95.502.0135.0	149	98.290.1000.0	54	Z1.298.1253.0	28
58.504.5155.0	20	95.502.0135.1	149	98.290.1000.0	56	Z1.298.1253.0	90
58.504.5155.6	20	95.502.0150.0	149	98.290.1000.0	109	Z1.298.1353.0	28
58.504.6155.0	54	95.502.0170.0	149	98.290.1000.0	109	Z1.298.1353.0	90
58.504.6955.1	23	95.502.0197.0	149	98.290.1000.0	109	Z1.298.1653.0	28
58.504.7055.0	23	95.502.0198.0	149	98.290.1000.0	112	Z1.298.1653.0	90
58.504.7055.6	23	95.502.0199.0	149	98.290.1000.0	112	Z1.298.1753.0	28
58.504.9055.0	18	95.502.0225.1	149	98.290.1000.0	112	Z1.298.1753.0	90
58.504.9155.0	20	95.502.0235.1	149	98.290.1000.0	113	Z1.298.1853.0	28
58.504.9255.0	23	95.502.0604.0	149	98.290.1000.0	128	Z1.298.1853.0	90
58.504.9355.0	20	95.502.0607.0	149	98.290.1000.0	128	Z1.298.1953.0	28
58.504.XX55.9	24	95.502.0612.0	149	98.290.1000.0	128	Z1.298.1953.0	90
58.506.0055.0	14	95.502.0613.0	149	98.290.1000.0	129	Z1.298.2053.0	90
58.506.0055.6	14	95.502.0620.0	149	98.290.1000.0	135	Z1.299.3055.0	29
58.506.9055.0	18	95.502.0625.0	149	98.300.0000.0	136	Z1.299.3055.0	91
58.510.0055.0	15	95.502.0627.0	149	98.300.0010.0	136	Z1.299.3155.0	29
58.510.0055.6	15	95.502.0628.0	149	98.300.1000.0	136	Z1.299.3155.0	91
58.510.9055.0	19	95.502.0700.0	149	98.360.0000.0	136	Z1.299.3255.0	29
58.516.0055.0	15	95.502.0710.0	149	98.360.0004.0	136	Z1.299.3255.0	91
58.516.0055.6	15	95.502.0710.2	149	98.370.0000.0	136	Z1.299.3355.0	29
58.516.9055.0	19	95.502.0710.3	149	98.370.1000.0	136	Z1.299.3355.0	91
59.903.0155.0	97	95.502.0710.4	149	98.370.1001.0	136	Z1.299.4055.0	29
59.903.0255.0	97	95.502.0710.5	149	98.375.1000.0	136	Z1.299.4055.0	57
59.903.0355.0	97	95.502.0710.7	149	98.380.0000.0	136	Z1.299.4055.0	91
59.903.0455.0	97	95.502.0711.0	149	98.400.0000.0	134	Z1.299.4155.0	29
59.903.0555.0	97	95.503.0000.0	142	99.013.9999.9	154	Z1.299.4155.0	57
59.903.0655.0	97	95.503.0004.0	142	99.014.9999.9	154	Z1.299.4155.0	91
59.903.0755.0	97	95.503.0005.0	142	99.015.9999.9	154	Z1.299.4255.0	29
59.903.0855.0	97	95.503.0006.0	142	99.031.9999.9	154	Z1.299.4255.0	57
59.903.0955.0	97	95.503.0010.1	142	99.032.9999.9	154	Z1.299.4255.0	91
59.903.1055.0	97	95.503.0010.5	142	99.033.9999.9	154	Z1.299.9753.0	15
69.700.0953.0	101	95.503.0012.0	142	99.034.9999.9	154	Z1.299.9753.0	65
69.700.1853.0	101	95.503.0013.0	142	Z1.108.8453.0	139	Z1.299.9753.0	67
69.920.0553.0	138	95.503.0014.0	142	Z1.110.8855.0	97	Z1.299.9753.0	83
69.920.0653.0	139	98.090.0000.0	137	Z1.110.8855.6	97	Z1.299.9753.0	89
69.920.1053.0	138	98.090.0015.0	137	Z1.110.8855.7	97	Z1.299.9753.0	97
69.920.1253.0	138	98.190.0000.0	137	Z1.110.8955.0	97	Z1.299.9753.0	123
95.101.1100.0	157	98.190.1000.0	137	Z1.110.8955.6	97	Z1.299.9753.0	125
95.101.1200.0	157	98.210.0000.0	137	Z1.110.8955.7	97	Z1.299.9753.0	155
95.101.1300.0	157	98.220.0000.0	137	Z1.110.9055.0	97	Z1.980.0040.0	134
95.300.0500.0	156	98.290.0000.0	54	Z1.110.9055.6	97	Z1.980.0253.0	135
95.350.0100.0	157	98.290.0000.0	54	Z1.110.9055.7	97	Z2.803.3010.0	134

INDEX

PART NUMBER | PAGE

Z2.803.3110.0	134	Z5.553.2921.0	83	Z7.250.5327.0	43	Z7.261.1227.0	23
Z2.803.3210.0	134	Z5.553.2921.0	89	Z7.250.5327.0	43	Z7.261.1227.0	23
Z2.803.3310.0	134	Z5.553.2921.0	90	Z7.250.5427.0	43	Z7.261.1227.0	67
Z2.803.5010.0	134	Z5.553.2921.0	91	Z7.250.5427.0	43	Z7.261.1227.0	87
Z2.803.5110.0	134	Z5.553.2921.0	123	Z7.255.0227.0	154	Z7.261.1227.0	90
Z2.803.5210.0	134	Z5.553.2921.0	125	Z7.255.0227.0	154	Z7.261.1227.0	91
Z2.803.5310.0	134	Z5.553.2921.0	127	Z7.255.4227.0	29	Z7.261.1227.0	93
Z2.803.6010.0	134	Z5.553.2921.0	155	Z7.255.4227.0	30	Z7.261.1227.0	109
Z2.803.6110.0	134	Z5.553.2921.1	155	Z7.255.4227.0	30	Z7.261.1227.0	110
Z2.803.6210.0	134	Z5.553.2921.6	155	Z7.255.4227.0	30	Z7.261.1227.0	154
Z4.242.5053.0	149	Z5.553.3021.0	155	Z7.255.4227.0	154	Z7.261.1327.0	14
Z4.242.5153.0	149	Z7.211.0027.0	56	Z7.255.4227.0	154	Z7.261.1327.0	20
Z4.242.6053.0	149	Z7.211.0027.0	56	Z7.255.4327.0	29	Z7.261.1327.0	20
Z4.242.6353.0	149	Z7.211.0027.0	56	Z7.255.4327.0	30	Z7.261.1327.0	23
Z4.242.8053.0	149	Z7.211.0027.0	57	Z7.255.4327.0	30	Z7.261.1327.0	23
Z4.243.2053.0	149	Z7.211.0027.0	57	Z7.255.4327.0	30	Z7.261.1327.0	67
Z4.243.2053.0	150	Z7.211.0227.0	36	Z7.255.4627.0	29	Z7.261.1327.0	87
Z4.243.8453.0	138	Z7.211.0227.0	56	Z7.255.4627.0	30	Z7.261.1327.0	90
Z4.243.8453.0	139	Z7.211.0227.0	56	Z7.255.4627.0	30	Z7.261.1327.0	91
Z5.511.3553.0	39	Z7.211.0227.0	56	Z7.255.4627.0	30	Z7.261.1327.0	93
Z5.511.3553.6	39	Z7.211.0227.0	57	Z7.255.8227.0	39	Z7.261.1327.0	109
Z5.511.3553.7	39	Z7.211.0227.0	57	Z7.255.8227.0	154	Z7.261.1327.0	110
Z5.511.3553.8	39	Z7.211.0327.0	36	Z7.255.8327.0	39	Z7.261.1327.0	154
Z5.511.3553.9	39	Z7.211.0327.0	56	Z7.255.8327.0	154	Z7.261.1427.0	14
Z5.515.3310.0	135	Z7.211.0327.0	57	Z7.255.8427.0	39	Z7.261.1427.0	20
Z5.515.3410.0	135	Z7.211.0527.0	56	Z7.255.8527.0	39	Z7.261.1427.0	20
Z5.516.2511.0	137	Z7.211.0527.0	56	Z7.255.8627.0	39	Z7.261.1427.0	23
Z5.516.2711.0	137	Z7.211.0527.0	57	Z7.256.8427.0	154	Z7.261.1427.0	23
Z5.516.2811.0	137	Z7.211.0627.0	36	Z7.256.8527.0	154	Z7.261.1427.0	67
Z5.519.0310.0	135	Z7.212.1227.0	41	Z7.256.8527.0	154	Z7.261.1427.0	87
Z5.519.0410.0	135	Z7.212.1327.0	41	Z7.260.0029.0	103	Z7.261.1427.0	90
Z5.522.5010.0	139	Z7.212.1427.0	41	Z7.260.0229.0	103	Z7.261.1427.0	91
Z5.522.7553.0	139	Z7.212.1527.0	41	Z7.260.0329.0	103	Z7.261.1427.0	93
Z5.522.8553.0	138	Z7.212.2027.0	41	Z7.260.0429.0	103	Z7.261.1427.0	154
Z5.523.5753.0	139	Z7.212.2227.0	41	Z7.260.0529.0	103	Z7.261.1527.0	14
Z5.523.9353.0	138	Z7.212.2327.0	41	Z7.260.1029.0	103	Z7.261.1527.0	20
Z5.523.9453.0	138	Z7.212.2427.0	41	Z7.261.1127.0	81	Z7.261.1527.0	20
Z5.553.2921.0	65	Z7.215.4027.0	50	Z7.261.1127.0	83	Z7.261.1527.0	21
Z5.553.2921.0	67	Z7.215.4227.0	50	Z7.261.1127.0	85	Z7.261.1527.0	21
Z5.553.2921.0	68	Z7.215.4327.0	50	Z7.261.1127.0	87	Z7.261.1527.0	23
Z5.553.2921.0	69	Z7.215.4627.0	50	Z7.261.1127.0	154	Z7.261.1527.0	23
Z5.553.2921.0	71	Z7.220.0227.0	36	Z7.261.1227.0	14	Z7.261.1527.0	67
Z5.553.2921.0	74	Z7.220.0227.0	36	Z7.261.1227.0	20	Z7.261.1527.0	87
Z5.553.2921.0	75	Z7.220.0627.0	36	Z7.261.1227.0	20	Z7.261.1527.0	90
Z5.553.2921.0	77	Z7.250.5227.0	43	Z7.261.1227.0	21	Z7.261.1527.0	91
Z5.553.2921.0	77	Z7.250.5227.0	43	Z7.261.1227.0	21	Z7.261.1527.0	93



INDEX

PART NUMBER | PAGE

Z7.261.1527.0	154	Z7.267.0327.6	25	Z7.280.3227.0	22	Z7.280.6327.0	154
Z7.261.1627.0	67	Z7.267.0327.6	26	Z7.280.3227.0	35	Z7.280.6427.0	14
Z7.261.1627.0	87	Z7.267.1227.5	25	Z7.280.6227.0	14	Z7.280.6427.0	65
Z7.261.1627.0	90	Z7.267.1227.5	26	Z7.280.6227.0	21	Z7.280.6427.0	81
Z7.261.1627.0	91	Z7.267.1227.6	25	Z7.280.6227.0	65	Z7.280.6427.0	83
Z7.261.1627.0	93	Z7.267.1227.6	26	Z7.280.6227.0	81	Z7.280.6427.0	85
Z7.261.1627.0	154	Z7.268.0227.0	63	Z7.280.6227.0	83	Z7.280.6427.0	89
Z7.261.1727.0	67	Z7.268.0227.0	78	Z7.280.6227.0	85	Z7.280.6427.0	97
Z7.261.1727.0	87	Z7.268.0227.0	78	Z7.280.6227.0	89	Z7.280.6427.0	99
Z7.261.1727.0	90	Z7.268.0227.0	154	Z7.280.6227.0	97	Z7.280.6427.0	112
Z7.261.1727.0	91	Z7.268.0327.0	63	Z7.280.6227.0	99	Z7.280.6427.0	113
Z7.261.1727.0	93	Z7.268.0327.0	154	Z7.280.6227.0	110	Z7.280.6427.0	113
Z7.261.1727.0	154	Z7.268.0427.0	63	Z7.280.6227.0	112	Z7.280.6427.0	123
Z7.261.1827.0	67	Z7.268.0427.0	154	Z7.280.6227.0	112	Z7.280.6427.0	125
Z7.261.1827.0	87	Z7.268.0527.0	63	Z7.280.6227.0	112	Z7.280.6427.0	154
Z7.261.1827.0	90	Z7.268.0527.0	78	Z7.280.6227.0	113	Z7.280.6527.0	14
Z7.261.1827.0	91	Z7.268.0527.0	78	Z7.280.6227.0	113	Z7.280.6527.0	21
Z7.261.1827.0	93	Z7.268.0527.0	154	Z7.280.6227.0	123	Z7.280.6527.0	65
Z7.261.1827.0	154	Z7.268.1027.0	63	Z7.280.6227.0	125	Z7.280.6527.0	81
Z7.261.1927.0	67	Z7.268.1027.0	78	Z7.280.6227.0	128	Z7.280.6527.0	83
Z7.261.1927.0	87	Z7.268.1027.0	78	Z7.280.6227.0	128	Z7.280.6527.0	85
Z7.261.1927.0	90	Z7.268.1027.0	154	Z7.280.6227.0	128	Z7.280.6527.0	89
Z7.261.1927.0	91	Z7.270.0227.0	25	Z7.280.6227.0	129	Z7.280.6527.0	97
Z7.261.1927.0	93	Z7.270.0227.0	26	Z7.280.6227.0	129	Z7.280.6527.0	99
Z7.261.1927.0	154	Z7.270.0327.0	25	Z7.280.6227.0	154	Z7.280.6527.0	112
Z7.261.2027.0	14	Z7.270.0327.0	26	Z7.280.6327.0	14	Z7.280.6527.0	113
Z7.261.2027.0	20	Z7.270.1227.0	25	Z7.280.6327.0	65	Z7.280.6527.0	113
Z7.261.2027.0	20	Z7.270.1227.0	26	Z7.280.6327.0	81	Z7.280.6527.0	123
Z7.261.2027.0	21	Z7.271.2227.0	50	Z7.280.6327.0	83	Z7.280.6527.0	125
Z7.261.2027.0	21	Z7.271.2327.0	50	Z7.280.6327.0	85	Z7.280.6527.0	154
Z7.261.2027.0	23	Z7.271.3227.0	50	Z7.280.6327.0	89	Z7.280.6627.0	65
Z7.261.2027.0	23	Z7.271.4227.0	37	Z7.280.6327.0	97	Z7.280.6627.0	89
Z7.261.2027.0	67	Z7.271.4327.0	37	Z7.280.6327.0	99	Z7.280.6627.0	97
Z7.261.2027.0	87	Z7.271.5227.0	37	Z7.280.6327.0	110	Z7.280.6627.0	99
Z7.261.2027.0	90	Z7.271.5227.0	56	Z7.280.6327.0	112	Z7.280.6627.0	125
Z7.261.2027.0	91	Z7.271.5227.0	56	Z7.280.6327.0	112	Z7.280.6627.0	154
Z7.261.2027.0	93	Z7.271.5227.0	56	Z7.280.6327.0	112	Z7.280.6727.0	65
Z7.261.2027.0	109	Z7.271.5227.0	57	Z7.280.6327.0	113	Z7.280.6727.0	89
Z7.261.2027.0	110	Z7.271.5227.0	57	Z7.280.6327.0	113	Z7.280.6727.0	97
Z7.261.2027.0	154	Z7.280.0227.0	27	Z7.280.6327.0	123	Z7.280.6727.0	99
Z7.267.0227.5	25	Z7.280.0327.0	27	Z7.280.6327.0	125	Z7.280.6727.0	125
Z7.267.0227.5	26	Z7.280.0627.0	27	Z7.280.6327.0	128	Z7.280.6727.0	154
Z7.267.0227.6	25	Z7.280.2227.0	22	Z7.280.6327.0	128	Z7.280.6827.0	65
Z7.267.0227.6	26	Z7.280.2227.0	35	Z7.280.6327.0	128	Z7.280.6827.0	89
Z7.267.0327.5	25	Z7.280.2327.0	22	Z7.280.6327.0	129	Z7.280.6827.0	97
Z7.267.0327.5	26	Z7.280.2327.0	35	Z7.280.6327.0	129	Z7.280.6827.0	99

INDEX

PART NUMBER | PAGE

Z7.280.6827.0	125	Z7.280.8027.0	129	Z7.283.8227.0	69	Z7.284.9527.0	55
Z7.280.6827.0	154	Z7.280.8027.0	154	Z7.283.8227.0	77	Z7.285.2227.0	16
Z7.280.6927.0	65	Z7.281.1227.0	37	Z7.283.8227.0	109	Z7.285.2327.0	16
Z7.280.6927.0	89	Z7.281.1327.0	37	Z7.283.8227.0	111	Z7.285.2627.0	16
Z7.280.6927.0	97	Z7.281.2227.0	37	Z7.283.8227.0	154	Z7.285.3227.0	16
Z7.280.6927.0	99	Z7.281.3227.0	36	Z7.284.4227.0	15	Z7.285.4227.0	55
Z7.280.6927.0	125	Z7.281.3327.0	36	Z7.284.4227.0	70	Z7.285.4327.0	55
Z7.280.6927.0	154	Z7.281.3627.0	36	Z7.284.4227.0	70	Z7.285.4427.0	55
Z7.280.7027.0	14	Z7.282.2227.0	42	Z7.284.4227.0	77	Z7.285.4527.0	55
Z7.280.7027.0	21	Z7.282.2327.0	42	Z7.284.4227.0	109	Z7.285.6227.0	70
Z7.280.7027.0	65	Z7.282.3227.0	42	Z7.284.4227.0	111	Z7.285.6227.0	77
Z7.280.7027.0	81	Z7.282.4227.0	110	Z7.284.4227.0	111	Z7.285.6227.0	154
Z7.280.7027.0	83	Z7.282.5227.0	14	Z7.284.4227.0	154	Z7.285.6427.0	69
Z7.280.7027.0	85	Z7.282.5227.0	68	Z7.284.7027.0	118	Z7.285.6427.0	71
Z7.280.7027.0	89	Z7.282.5227.0	75	Z7.284.7027.0	120	Z7.285.6427.0	154
Z7.280.7027.0	97	Z7.282.5227.0	127	Z7.284.7027.0	120	Z7.286.3227.0	16
Z7.280.7027.0	99	Z7.282.5227.0	154	Z7.284.7027.0	154	Z7.286.3327.0	16
Z7.280.7027.0	110	Z7.282.5327.0	14	Z7.284.7027.5	121	Z7.286.3627.0	16
Z7.280.7027.0	112	Z7.282.5327.0	68	Z7.284.7027.6	121	Z7.287.0227.0	33
Z7.280.7027.0	112	Z7.282.5327.0	75	Z7.284.7127.0	118	Z7.287.0327.0	33
Z7.280.7027.0	112	Z7.282.5327.0	127	Z7.284.7127.0	120	Z7.287.0627.0	33
Z7.280.7027.0	113	Z7.282.5427.0	14	Z7.284.7127.0	120	Z7.287.1227.0	16
Z7.280.7027.0	113	Z7.282.5427.0	68	Z7.284.7127.0	154	Z7.287.1327.0	16
Z7.280.7027.0	123	Z7.282.5427.0	75	Z7.284.7127.5	121	Z7.311.1755.0	153
Z7.280.7027.0	125	Z7.282.5427.0	127	Z7.284.7127.6	121	Z7.311.7055.0	153
Z7.280.7027.0	128	Z7.282.5527.0	14	Z7.284.7227.0	118	Z7.409.5753.0	48
Z7.280.7027.0	128	Z7.282.5527.0	68	Z7.284.7227.0	120	Z7.409.5853.0	48
Z7.280.7027.0	128	Z7.282.5527.0	75	Z7.284.7227.0	120	Z7.409.5853.0	49
Z7.280.7027.0	129	Z7.282.5527.0	127	Z7.284.7227.0	154	Z7.409.5853.0	49
Z7.280.7027.0	129	Z7.282.5527.0	154	Z7.284.7227.5	121		
Z7.280.7027.0	154	Z7.282.6229.0	39	Z7.284.7227.6	121		
Z7.280.8027.0	14	Z7.282.6329.0	39	Z7.284.7327.0	118		
Z7.280.8027.0	21	Z7.282.6429.0	39	Z7.284.7327.0	120		
Z7.280.8027.0	65	Z7.282.6529.0	39	Z7.284.7327.0	120		
Z7.280.8027.0	81	Z7.282.6629.0	39	Z7.284.7327.0	154		
Z7.280.8027.0	83	Z7.282.7229.0	39	Z7.284.7327.5	121		
Z7.280.8027.0	85	Z7.282.7329.0	39	Z7.284.7327.6	121		
Z7.280.8027.0	89	Z7.282.7429.0	39	Z7.284.7427.0	118		
Z7.280.8027.0	97	Z7.283.2227.0	42	Z7.284.7427.0	120		
Z7.280.8027.0	99	Z7.283.2227.0	55	Z7.284.7427.0	120		
Z7.280.8027.0	123	Z7.283.2327.0	42	Z7.284.7427.0	154		
Z7.280.8027.0	125	Z7.283.2327.0	55	Z7.284.7427.5	121		
Z7.280.8027.0	128	Z7.283.2427.0	55	Z7.284.7427.6	121		
Z7.280.8027.0	128	Z7.283.2527.0	55	Z7.284.9227.0	55		
Z7.280.8027.0	128	Z7.283.3227.0	42	Z7.284.9327.0	55		
Z7.280.8027.0	129	Z7.283.8227.0	15	Z7.284.9427.0	55		



OUR **SECTOR KNOWLEDGE**

We have developed special industry knowledge in a wide variety of specialized fields. This forms the basis of our successful solutions.



Machine and system construction



Conveying technology



Renewable energy



Heating, ventilation and air conditioning systems

OUR **SOLUTIONS RANGE**

for machine building and plant engineering.



podis® – Power bus system installed safely and decentralized with high IP rating



RST® – Round connectors offer highest reliability with IP 69 rating



revos – Industrial connectors for reliable power and signal distribution



fasis + selos – Terminal blocks for the perfect fit in small spaces



Components and solutions for the safety of machines and plants



wiecon – extensive portfolio of pluggable connectors for circuit boards



wipos power supply and wienet switches allow for an industrial network and data technology



wienet – Router and switches for a reliable communication all over the world



INFO TO GO

All brochures from Wieland Electric are available for download on our website.

<https://www.wieland-electric.com/en/support/downloads>

Interesting for you

<https://wie.li/webterminalblocks>



Wieland on YouTube
See our solutions
in motion

<https://www.youtube.com/user/WielandElectric>



Technical consultation
Industry Solutions

Email: industry@wieland-electric.com

Worldwide: <https://wie.li/contactinternational>



ONLY ONE TAP AWAY

Our Wieland E-Shop
Over 25,000 products - anytime

In our online store you will find all the information about our products, prices, and technical data.

Order easily and conveniently online, and check availability.

<https://eshop.wieland-electric.com>

Scan QR code –
view products in the
E-SHOP.





wieland

HEADQUARTERS

Wieland Electric GmbH
Brennerstraße 10 – 14
96052 Bamberg · Germany

Phone +49 951 9324-0
Fax +49 951 9324-198
info@wieland-electric.com

0500.1 K 07/22

Represented in over 70 countries worldwide:

www.wieland-electric.com